

# IMPORTANT SAFETY INFORMATION

# BCSI

**BUILDING COMPONENT SAFETY INFORMATION**

**Guide to Good Practice for Handling, Installing, Restraining  
& Bracing of Metal Plate Connected Wood Trusses**



**NOTICE**



**NOTICE**

**WARNING**

**CAUTION**

**DANGER**

JOINTLY PRODUCED BY



2013 EDITION



**NOTICE**



**WARNING**



**CAUTION**



**DANGER**

Use of the words above in any language should tell the reader that an unsafe condition or action will greatly increase the probability of an accident occurring that results in serious personal injury or death. Disregarding or ignoring handling, installing, restraining and bracing safety recommendations is the major cause of Structural Building Component erection/installation accidents.

The erection/installation of Structural Building Components is inherently dangerous and requires, above all, careful planning and communication between the Contractor involved with the erection/installation, installation crew and the crane operator. Depending on the experience of the Contractor, it is strongly recommended that a meeting be held with all onsite individuals involved in the lifting/hoisting, installing and temporary/permanent restraint/bracing operations to review the provisions of the Building Component Safety Information (BCSI) book, the Truss Design Drawings, the Construction Documents (i.e., architectural/structural plans and specifications), the Truss Placement Diagram (if/when required by the Contract), OSHA jobsite lifting and fall protection requirements (see **BCSI-B11**), the erection plan and installation plan (if provided) and site-specific environmental issues.

It is recommended that this review process be followed before any Truss handling operations are performed. It is also recommended that this meeting be held before any Truss handling at each new jobsite and be repeated for any individuals newly assigned to the erection/installation operation. Proper restraint and Bracing of Trusses requires an understanding of triangulation in the various planes perpendicular to the planes of the members of the Trusses. This understanding is essential for a safe installation. The Contractor involved with the erection/installation shall be familiar with general Lateral Restraint and Bracing concepts as discussed in the above-referenced industry publications. It is not intended that these recommendations be interpreted as superior to the Building Designer's design specification for handling, installing, restraining and Bracing Trusses and it does not preclude the use of other equivalent methods for restraining/Bracing and providing stability for the walls, columns, floors, roof and all the interrelated Structural Building Components as determined by the Contractor.

**WARNING** The handling, storing, installing, restraining and Bracing of Trusses requires specialized training, clearly implemented procedures, and careful planning and communication among the Contractor, all installation crews and any crane operators. Property damage and/or serious bodily injury is one possible result when handling and installing Trusses without appropriate training, planning and communication.

Prior to Truss installation, it is recommended that the documents be examined and disseminated to all appropriate personnel. In addition to proper training and a clear understanding of the installation plan, any applicable fall protection requirements and the intended restraint/Bracing requirements shall be understood.

Examine the structure, including the framing system, bearing locations, and related installation locations and begin Truss installation only after any unsatisfactory conditions have been corrected. Do not cut, modify, or repair components. Report any damage before installation.

The information in this book is offered as a minimum guideline only. Nothing contained in BCSI shall be construed in any manner as expanding the scope of responsibility of, or imposing any additional liabilities on the Truss Manufacturer.

Every project has different site conditions that can have a specific effect on the erection process. Before the first Truss is erected, every individual involved shall understand the plan for hoisting and Truss setting and the intended temporary restraint and Bracing requirements for a safe, efficient and accident-free jobsite.

**Precautionary Note to Users of BCSI**

This *Guide to Good Practice for Handling, Installing, Restraining & Bracing Metal Plate Connected Wood Trusses* (BCSI) may be edited, changed, revised or withdrawn at any time. Purchasers and users of this guide are advised to visit the products section of [sbcindustry.com](http://sbcindustry.com) to confirm that this edition is the most current information available. Use only the latest edition. Additionally, errata and updates are published periodically and are available at [sbcindustry.com/bcsi.php](http://sbcindustry.com/bcsi.php).

**EDITOR'S NOTE:** Capitalized terms found throughout this document are defined in the "Glossary of Terms" (see pages 91-96).



# **BCSI** **BUILDING COMPONENT SAFETY INFORMATION**

## **Guide to Good Practice for Handling, Installing, Restraining & Bracing of Metal Plate Connected Wood Trusses**

**JOINTLY PRODUCED BY**

**Structural Building Components Association (SBCA)**

AND

**Truss Plate Institute (TPI)**

Published – March 2013

Replaces BCSI 2006 Edition

Copyright © 2006-2013

Structural Building Components Association and Truss Plate Institute  
All rights reserved. This book or any part thereof may not be reproduced in any form  
without the written permission of the publisher. Printed in the United States of America.

### ACKNOWLEDGEMENTS

---

The thoughts, ideas and hard work of many have brought this edition of the Building Component Safety Information (BCSI) document to press.

Special thanks to SBCA's membership in its entirety for perspective and feedback in guiding the creation of this work, under the leadership of the Executive Committee and Board. Special thanks are also due to each of the TPI Member Companies: Cherokee Metal Products, CompuTrus, Eagle Metal Products, ITW Building Components Group Inc., MiTek Industries, Robbins Engineering, and TEE-LOK Corporation.

Certain individuals have been especially dedicated to making BSCI possible: Scott Arquilla; Rich Avery; Bruce Bain; Paul Bartholomew; Dave Brakeman, PE., S.E.; Junaidie Budiman, PE.; Mike Bugbee; Steve Cabler, PE.; Mike Cassidy, R.A.; Steve Cramer, PE.; Bob Dayhoff; Dave Denoncourt; Chris Diedrich, PE.; Johnny Drozdek, PE.; Allen Erickson; John Ernst, PE.; Howard Gauger; Dave Gromala, PE.; John Gruber, PE., S.E.; Aaron Halberg, PE.; Steve Hanek; Joe Heinsman, PE.; David Horne, PE.; Paul Johnson, PE.; Dave Johnston, PE.; Mike Karceski; Steve Kennedy, E.I.; Ted Kolanko, PE.; Mike Kozlowski, PE.; Earl Latham; Stu Lewis, PE.; Mark Luther, PE.; Pat McGuire, PE.; Mike Magid, PE.; John Meeks, PE.; Joe Michels, PE.; David Motter, PE.; David Nelson, PE.; Mike Nilles; Gary Obudzinski, PE.; Kent Reimschuessel, PE.; Tim Riegel, PE.; Chris Rizer, E.I.; Jim Schreiber; Norm Scheel, PE., S.E.; Don Scott, PE.; Robert Shupe, PE.; Kelly Sias, PE.; Mike Sinniger; Marvin Strzyzewski, PE.; Bob Tibbits, PE.; Larry Wainright; Allen Washburn; David Weaver, PE.; Dave Wert, PE.; Larry Wilder, PE. and Stephanie Young, PE.

SBCA would like to thank those who serve on its Engineering & Technology and Marketing Committees, and TPI would like to thank those who serve on its Technical Advisory Committee (TAC) for their continued dedication to advancing our industry's work on safety and technology.

Finally, a key thank you must go to those that tended to all the details in the background, without which this document would not be completed. This group includes Art Hernandez, PE., Dave Brake- man, PE., S.E.; Jay Jones, PE. and Mike Cassidy, R.A. of TPI; Bob Dayhoff, Melinda Caldwell; Ryan Dexter, PE.; Agron Gjinolli, PE.; Kirk Grundahl, PE.; Keith Hershey; Brooke Kutz; Trish Kutz; Denise Lane; Libby Maurer; Anita Merideth; Sherry Misener; Emily Pat- terson, Marisa Peters; Sean Shields; Rachel Smith, PE.; Jim Vogt, PE.; Jill Zimmerman and Richard Zimmermann of SBCA staff.

### PHOTO AND GRAPHIC ARTS CREDITS

---

Graphic art, photographs, sketches, drawings, forms, and table formats that appear in this document have come from many sources, some known and others unknown. SBCA and TPI wish to thank the following known suppliers of graphic materials for this BCSI book:

- Cherokee Metal Products, Inc.
- Eagle Metal Products
- ITW Building Components Group Inc.
  - Alpine Engineered Products
  - Truswal Systems
- MiTek Industries, Inc.
  - CompuTrus, Inc.
  - USP Structural Connectors
- Robbins Engineering, Inc.
- Sheppard Engineering, P.C.
- Simpson Strong-Tie Company

# CONTENTS

Notice/Warning/Caution/Danger.....	i	General Notes .....	16
Precautionary Note to Users of BCSI .....	i	<b>BCSI-B2 Truss Installation &amp; Temporary Restraint/Bracing</b> ...	17
Acknowledgements.....	iv	Considerations Before Starting .....	18
Photo and Graphic Arts Credits .....	iv	General Safety Reminders .....	18
Introduction .....	vii	Summary of the Eight Steps in the Truss Installation Process .....	19
Publications Background.....	vii	Details of the Eight-Step Truss Installation Process .....	20
Important Note Regarding On-Center Spacing.....	viii	Alternate Installation Method .....	29
SI Unit Conversions.....	viii	Hip Set Assembly & Bracing .....	30
Jobsite Package Cover Sheet.....	viii	Long Span Truss Installation .....	32
Checklist for Handling & Installing Trusses.....	ix	Field Assembly & Other Special Conditions.....	34
Building Designer Information.....	x	Valley Set Frame Installation.....	35
Building Designer Checklist .....	x	Special Applications Using Trusses .....	36
Acronyms and Initialisms.....	xii	Other Applications Requiring Special Restraint/Bracing ...	36
<b>BCSI-B1 Guide for Handling, Installing,     Restraining &amp; Bracing of Trusses</b> .....	1	<b>BCSI-B3 Permanent Restraint/Bracing     of Chords &amp; Web Members</b> .....	37
Temporary Installation Restraint/Bracing .....	2	Restraint/Bracing Materials & Fasteners.....	38
Permanent Individual Truss Member Restraint .....	2	Using Temporary Restraint/Bracing as Permanent Restraint/Bracing .....	38
Special Design Requirements .....	3	Permanent Bracing for the Various Planes of a Roof Truss .....	38
Unloading & Lifting .....	3	Permanent Bracing for Special Conditions .....	51
Jobsite Handling .....	3	<b>BCSI-B4 Construction Loading</b> .....	53
Crane Use & Proper Truss Handling.....	4	Construction Loading Do's and Don'ts .....	53
Hoisting & Placement of Truss Bundles .....	6	<b>BCSI-B5 Truss Damage, Jobsite Modifications     &amp; Installation Errors</b> .....	55
Mechanical Hoisting Recommendations for Single Trusses	8	Follow These Steps to Correct Damage, Jobsite Modifications or Installation Errors .....	55
Installation of Single Trusses by Hand .....	9	Common Repair Techniques.....	55
Restraint/Bracing Material & Connections.....	9	Examples of Common Damage, Modifications and Installation Errors .....	56
Beginning the Erection/Installation Process.....	10	<b>Notice Regarding BCSI-B6</b> .....	57
Ground Brace - Exterior.....	10	<b>BCSI-B7 Temporary &amp; Permanent Restraint/Bracing     of 3x2 and 4x2 Parallel Chord Trusses</b> .....	59
Ground Brace - Interior.....	10	Standard Floor Details .....	59
Installation Tolerances.....	11	Storage and Handling.....	59
Restraint/Bracing Warnings .....	11	Common Installation Errors.....	59
Temporary Installation Restraint/Bracing Requirements for the Various Planes of a Roof Truss .....	12	Installation Restraint/Bracing Requirements .....	60
Alternative Methods of Temporary Installation Restraint/Bracing .....	14		
Restraint & Bracing 3x2 & 4x2 Parallel Chord Trusses ....	14		
Construction Loading.....	15		
Additional Notes.....	16		

# Building Component Safety Information

Permanent Restraint & Bracing.....	61	General Safety Reminders.....	74
Strongbacking Provisions.....	61	Truss Storage.....	75
Construction Loading.....	62	Mechanical Installation.....	76
Alterations.....	62	Temporary Installation Restraint/Bracing Principles.....	77
Special Conditions.....	62	Top Chord Temporary Lateral Restraint Schedule.....	79
<b>BCSI-B8 Using Toe-Nailed Connections to Attach Trusses At Bearing Locations.....</b>	<b>63</b>	Permanent Restraint/Bracing.....	80
General.....	63	Using Temporary Restraint/Bracing as Permanent Restraint/Bracing.....	80
Factors Affecting the Strength of a Toe-Nailed Connection.....	63	Restraint/Bracing Materials & Fasteners.....	80
Toe-Nailing Used with Bottom Bearing Applications.....	64	Permanent Bracing for the Various Planes of a Roof Truss.....	81
How Much Uplift & Lateral Resistance Can Toe-Nailing Provide?.....	65	Permanent Bracing for Special Conditions.....	85
Load Duration Factor, $C_D$ (for Connections).....	66	Permanent Bracing for the Top Chord in a Piggyback Assembly.....	86
Toe-Nailing Used to Attach Jack Trusses to a Girder.....	66	<b>BCSI-B11 Fall Protection &amp; Trusses.....</b>	<b>87</b>
Other Types of Uplift Connections.....	68	Truss Systems.....	87
Non-Bearing Wall Considerations.....	68	Site-Specific Job Hazard Assessment.....	88
<b>BCSI-B9 Multi-Ply Girders.....</b>	<b>69</b>	Fall Protection Equipment Installation.....	88
Ply-to-Ply Connection Requirements.....	69	Alternative Fall Protection Plans.....	89
Good Installation Practices.....	70	<b>Glossary of Terms.....</b>	<b>91</b>
Fastener Guidelines.....	70	<b>Reference.....</b>	<b>97</b>
Nail Fasteners.....	70	Industry Associations & Governmental Agencies.....	97
Screw Fasteners.....	71	Industry Standards, Guidelines & Recommendations.....	97
Bolt Fasteners.....	71	Supplemental Information Tags.....	98
<b>BCSI-B10 Post Frame Truss Installation, Restraint &amp; Bracing.....</b>	<b>73</b>	Quick Reference Guide to BCSI B-Series	
Considerations Before Starting.....	74	Summary Sheets.....	Back Cover



## INTRODUCTION

The Structural Building Components Association (SBCA) and Truss Plate Institute (TPI) have each adopted policies to promote handling, installing, restraining and bracing guidelines for Metal Plate Connected Wood Trusses that are simple, safe, proven methods consistent with accepted framing construction practices in the field. The intention of this Building Component Safety Information (BCSI) book is to implement those policies.

The methods and procedures in BCSI are intended to ensure that the overall construction techniques employed will put floor and roof Trusses in place safely. These recommendations for handling, installing, restraining and Bracing Trusses are based upon the collective experience of leading personnel involved with Truss design, manufacturing and installation, but must, due to the nature of responsibilities involved, be presented only as a guide for use by a qualified Building Designer and/or Contractor. It is not intended that these recommendations be interpreted as superior to the Building Designer's design specification for handling, installing, restraining and Bracing Trusses and it does not preclude the use of other equivalent methods for restraining/Bracing and providing stability for the walls, columns, floors, roofs and all the interrelated Structural Building Components as determined by the Contractor. Thus, SBCA, TPI and those who participated in the development of this guide expressly disclaim any responsibility for damages arising from the use, application, or reliance on the recommendations and information contained herein.

## PUBLICATIONS BACKGROUND

The first edition of the BCSI book (BCSI 1-03) was developed by SBCA and TPI to replace HIB-91, *Commentary and Recommendations for Handling, Installing and Bracing Metal Plate Connected Wood Trusses*. The BCSI book was developed using DSB-89, *Recommended Design Specification for Temporary Bracing of Metal Plate Connected Wood Trusses*; HIB-91; HIB-91 (Summary Sheet); HIB-98, *Recommendations for Handling, Installing and Temporary Bracing of Metal Plate Connected Wood Trusses Used in Post-Frame Construction*; and several bracing, warning and safety documents existing at the time. The consistent message throughout all of these documents is that proper Truss handling, installing, restraining and Bracing are crucial for consistent jobsite safety and acceptable structural performance. More information regarding the design and manufacturing of metal plate connected wood Trusses is provided in ANSI/TPI 1-2007, *National Design Standard for Metal Plate Connected Wood Trusses*, and the 3rd edition of the *Metal Plate Connected Wood Truss Handbook* published by SBCA.

The sections of this book are available as B-Series Summary Sheets. Each Summary Sheet condenses the information contained in the corresponding section of this book into a few pages that emphasize the main points using a graphical representation of the text as fully as possible. The goal is to provide clear, concise information for jobsite users so they can implement the handling, installing, restraining and Bracing concepts contained herein more easily.

The B-Series Summary Sheets include:

**BCSI-B1 Summary Sheet - Guide for Handling, Installing, Restraining & Bracing of Trusses:** This guide for builders features proper techniques for unloading, storing, lifting, erecting, installing, restraining and Bracing Trusses. It includes specific information for protecting Trusses from weather and damage at the jobsite, how to lift bundles and individual Trusses by crane, restraining/Bracing guidelines to prevent Trusses from toppling during erection, installation tolerances to keep the Trusses in plane and plumb and basic Construction Loading and materials placement recommendations. Numerous graphics accompanied by written instructions provide an easy-to-follow reference. A supplemental warning tag can be attached to individual Trusses urging erection/installation Contractors to refer to **BCSI-B1** for more Bracing information.

**BCSI-B2 Summary Sheet - Truss Installation & Temporary Restraint/Bracing:** Temporary restraint/Bracing is an important, yet often overlooked, element of safe Truss installation. **BCSI-B2** provides options for safe temporary restraint/Bracing installations and strongly emphasizes how all Lateral Restraint needs to be stabilized with Diagonal Bracing, while showing how to get the first five Trusses erected, restrained and Braced efficiently and safely for the benefit of the crew and the project.

**BCSI-B3 Summary Sheet - Permanent Restraint/Bracing of Chords & Web Members:** Permanent Bracing must provide sufficient support at right angles to the plane of the Truss to hold every Truss member in the position assumed for it in the design. **BCSI-B3** reviews the various planes of the Truss that typically must be restrained/Braced and provides installation guidelines for Gable End Frame restraint/Bracing, individual chord and web member Permanent restraint/Bracing, web member reinforcement and Permanent restraint/Bracing for special conditions.

**BCSI-B4 Summary Sheet - Construction Loading:** During construction, Trusses must not support any loads from equipment or construction materials until the Truss assembly is properly restrained and braced. This document provides safe stack heights for several materials and illustrates good and bad loading practices.

**BCSI-B5 Summary Sheet - Truss Damage, Jobsite Modifications & Installation Errors:** Trusses are engineered components that can be damaged through mishandling, jobsite modification or improper installation. This Summary Sheet provides information on what to do if Trusses become damaged during the construction process.

The following B-Series Summary Sheets were specifically created for special conditions that are encountered during the Truss installation and Bracing process:

**BCSI-B7 Summary Sheet - Guide for Handling, Installing and Bracing of 3x2 and 4x2 Parallel Chord Trusses:** Floor Trusses are more stable during installation because they are built with the wide-face of the lumber oriented horizontally. Nevertheless, it is important to observe good installation, restraint and Bracing practices so floor systems are installed safely and successfully, and offer better long-term floor performance.

**BCSI-B8 Summary Sheet - Using Toe-Nailed Connections to Attach Trusses at Bearing Locations:** Toe-nailing is commonly used to attach Metal Plate Connected Wood Trusses (MPCWT) and other wood-based framing components to their supports. **BCSI-B8** contains guidelines for using toe-nailed Connections and provides uplift and lateral resistance capacities for these Connections. Connection options are also discussed for when toe-nailing is not enough.

**BCSI-B9 Summary Sheet - Multi-Ply Girders:** Multiple-ply Girder Trusses consist of two or more individual Trusses that must be attached together to act as a single member. **BCSI-B9** discusses various attachment methods and types of fasteners.

**BCSI-B10 Summary Sheet - Post Frame Truss Installation, Restraint & Bracing:** Metal Plate Connected Wood Trusses are commonly used in post frame construction. This Summary Sheet provides guidelines for the proper handling, installing, restraining and Bracing of flat Bottom Chord MPCWT spaced >2' to 12' on-center in engineered post frame building system applications.

**BCSI-B11 Summary Sheet - Fall Protection & Trusses:** Trusses are NOT designed to be fall protection anchors. **BCSI-11** provides general guidelines to assist framing crews to safely and efficiently install Trusses while meeting OSHA's fall protection guidelines.

All BCSI Summary Sheets are viewable online and are available at [sbccindustry.com/bcsi.php](http://sbccindustry.com/bcsi.php).

## IMPORTANT NOTE REGARDING ON-CENTER SPACING

BCSI is primarily directed toward Truss installations in which the on-center (o.c.) spacing is 24" or less. The exception to this is **BCSI-B10**, which covers spacings greater than 24" o.c. Truss spacing of 19.2", 16" and 12" o.c. are occasionally used. These closer o.c. spacings are acceptable using the handling, installing and Bracing criteria of this book.

## SI UNIT CONVERSIONS

1" = 25.4mm

1' = 0.305m

1 lb/ft = 0.01459 kN/m

1 lb/ft<sup>2</sup> = 0.0479 kN/m<sup>2</sup>

## JOBSITE PACKAGE COVER SHEET

SBCA has created a "JOBSITE PACKAGE" cover sheet that may be included with a jobsite package for each job. The jobsite package typically provides one or more of the BCSI Summary Sheets, the Truss Design Drawings for the project, the Truss Placement Diagram (if/when required by the Contract) and other key information as determined by the Truss Manufacturer.

# JOBSITE PACKAGE

## IMPORTANT DOCUMENTS ENCLOSED

### PLEASE REVIEW

**⚠ WARNING:** The handling, storing, installing, restraining and diagonal bracing of structural building components requires specialized training, clearly implemented procedures, and careful planning and communication among the contractor, crane operator and installation crew. Handling and installing components without appropriate training, planning and communication greatly increases the probability of an accident resulting in property damage, serious personal injury and/or death.

Prior to component installation, the documents should be examined and disseminated to all appropriate personnel, in addition to proper training and a clear understanding of the installation plan, any applicable fall protection requirements, and the intended restraint and bracing requirements. Trusses with clear spans of 60 feet or greater in length are very dangerous to install and may require complex temporary and permanent bracing. Please consult a Registered Design Professional.

Examine the building, the building's structural framing system, bearing locations and related installation conditions. Begin component installation only after any unsatisfactory conditions have been corrected. Do not cut, modify or repair components. Report any damage before installation.

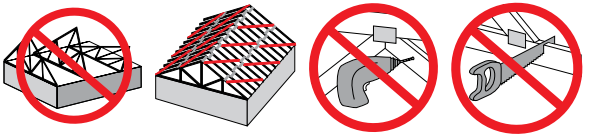
The enclosed documents are offered as minimum guidelines only. Nothing contained in this jobsite package should be construed in any manner as expanding the scope of responsibility of, or imposing any additional liabilities on, the component manufacturer.

**¡ADVERTENCIA!** El manejo, almacenamiento, instalación, restricción y arrioste diagonal de componentes estructurales de construcción requieren entrenamiento especializado, procedimientos claramente implementados y planificación y comunicación clara entre el contratista, operador de grúa, y los obreros de instalación. El manejar e instalar los componentes sin entrenamiento suficiente, planificación y comunicación adecuadas aumenta la probabilidad de un accidente que resulta en dano a propiedad, herida seria o muerte.

Antes de la instalación de componentes, los documentos adjuntos deben ser examinados y difundidos a todo el personal apropiado, además del entrenamiento pertinente y un claro entendimiento del plan de instalación, de todo requisito aplicable de la protección contra la caída y de los requisitos previstos de arrioste y restricción. La instalación de trusses con tramos despejados y más de 60 pies de largo es muy peligrosa y puede requiere el arrioste temporal y permanente complejo. Por favor, consulte a un Profesional de Diseño Registrado.

Examine la estructura, el sistema armazón estructural de edificio, ubicaciones de soporte e las condiciones de instalación correspondientes y comenzar con la instalación de los componentes sólo después de haber corregido toda condición insatisfactoria. No corte, modifique ni repare los componentes y informe cualquier daño descubierto antes de proceder a la instalación.

Los documentos adjuntos se ofrecen solamente como directrices mínimas. Nada de lo incluido en este paquete debe interpretarse de manera que exceda el alcance de la responsabilidad del fabricante de componentes, ni en forma tal que imponga responsabilidades adicionales sobre éste.



To view a non-printing PDF of this document, visit [www.sbccindustry.com/jobsites](http://www.sbccindustry.com/jobsites).

**FOR DESIGN RESPONSIBILITIES SEE REVERSE**

## CHECKLIST FOR HANDLING & INSTALLING TRUSSES

SBCA has also created the “Checklist for Handling and Installing Trusses” that may also be included with a jobsite package. An example of this Checklist is provided below.

### Truss Technology

### IN BUILDING

**Checklist for Handling and Installing Trusses**  
**Lista de Verificación Para Manejar e Instalar Los Trusses**





Review all the information provided in the JOBSITE PACKAGE to ensure compliance with industry recommendations. Property damage, serious bodily injury and/or death are possible when handling and installing trusses without following the recommendations presented in the JOBSITE PACKAGE. This is particularly true when working with trusses with clear spans 60' and greater.

Property damage, serious bodily injury and/or death are possible when trusses are improperly handled, installed, restrained and/or braced. Installation of trusses can be dangerous, particularly long span trusses. Use the following checklist when handling and erecting trusses.

- Inspect the trusses** at the time of delivery and after installation for:
  - (1) Conformance with the Truss Design Drawings
  - (2) Dislodged/missing connector plates
  - (3) Cracked, dislodged or broken members
  - (4) Any other damage that may impair the structural integrity of the trusses

**Notify the truss manufacturer if truss repairs are needed.** After installation, if damage to the trusses is discovered that could weaken them, temporarily brace or support the trusses to prevent further damage and make sure the area remains clear of plumbing, electrical, mechanical runs, etc. until the required repairs have been properly completed.

**DO NOT cut, drill, relocate, add or remove** any truss member or metal connector plate until you have received instructions from the truss manufacturer.

- Protect trusses** from weather, corrosion, lateral bending, damage and deterioration when stored at the jobsite. When trusses are stored at the site, use blocking, stringers, pallets, platforms or other means of support to keep the trusses off of the ground or in a braced upright position to avoid damage.
- Carefully review** the truss design drawings (TDD) and the truss placement diagram (TPD) (if/when provided by contract, and all JOBSITE PACKAGE documents, prior to handling and installing trusses.

Revisar toda la información provista en el PAQUETE DE OBRA para asegurarse que cumplen con las recomendaciones de la industria. Daño a propiedad, herida seria y/o muerte son posibles cuando manejar e instalar trusses sin seguir los recomendaciones presentados en el PAQUETE DE OBRA. Especialmente cuando trabajar con trusses de 60 pies de largo o más.

Daño a propiedad, herida seria, y/o muerte son posibles cuando los trusses son manejados, instalados, restringidos y/o amostrados incorrectamente. La instalación de los trusses especialmente los trusses de vanos largos puede ser peligroso. Use la siguiente lista de verificación cuando se manejan o se levantan los trusses.

- Examine los trusses** cuando se los entreguen y después de la instalación para:
  - (1) Conformidad con los Dibujos de Diseño del Truss
  - (2) Placas de conexión fuera de lugar o perdidas
  - (3) Miembros rotos, descolocados o partidos
  - (4) Cualquier otro daño que pueda perjudicar la integridad estructural de los trusses.

**Avise al fabricante de trusses si reparaciones al truss son necesarios.** Después de la instalación, si daño a los trusses está descubierto que pueden debilitarlos, amoste o soporte los trusses temporariamente para prevenir más daño y asegúrese que el área queda libre de tuberías, las componentes eléctricas o mecánicas, etc. hasta que todos los reparaciones requeridas son completados correctamente.

**NO corte, perforo, reubique, añada o quite ningún miembro del truss o conector de metal hasta que haya recibido instrucciones del fabricante de trusses.**

- Proteja los trusses** del clima, de la corrosión de torceduras laterales, daño y deterioros cuando los guarde en la obra. Cuando trusses son guardado en sitio, use bloqueados, paletas, plataformas u otros tipos de soporte para almacenarlos fuera de la tierra o en posición vertical para evitar que se dañen.
- Revisar cuidadosamente** los dibujos de diseño del truss (TDD), el diagrama de instalación de trusses (TPD) si está provisto, y todos los documentos del PAQUETE DE OBRA antes de manejar e instalar los trusses.

Copyright © 2002-2010 Structural Building Components Association. All Rights Reserved. TTB#IBC/CHECK-110323

Review all the information provided in the JOBSITE PACKAGE to ensure compliance with industry recommendations. Property damage, serious bodily injury and/or death are possible when handling and installing Trusses without following the recommendations presented in the JOBSITE PACKAGE. This is particularly true when working with Trusses with clear spans 60' and greater.

Property damage, serious bodily injury and/or death are possible when Trusses are improperly handled, installed, restrained and/or braced. Installation of Trusses can be dangerous, particularly long span Trusses. Use the following checklist when handling and erecting Trusses:

- Inspect the Trusses at the time of delivery and after installation for:
  - (1) Conformance with the Truss Design Drawings
  - (2) Dislodged/missing connector plates
  - (3) Cracked, dislodged or broken members
  - (4) Any other damage that may impair the structural integrity of the Trusses

Notify the Truss Manufacturer if Truss repairs are needed. After installation, if damage to the Trusses is discovered that

could weaken them, temporarily brace or support the Trusses to prevent further damage. Make sure the area remains clear of plumbing, electrical, mechanical runs, etc. until the required repairs have been properly completed.

DO NOT cut, drill, relocate, add or remove any Truss member or Metal Connector Plate until you have received instructions from the Truss Manufacturer.

- Protect Trusses from weather, corrosion, Lateral Bending, damage and deterioration when stored at the jobsite. When Trusses are stored at the site, use Blocking, stringers, pallets, platforms or other means of support to keep the Trusses off of the ground or in a braced upright position to avoid damage.
- Carefully review the Truss Design Drawings, the Truss Placement Diagram (if/when required by Contract) and all JOBSITE PACKAGE documents prior to handling and installing Trusses.
- Examine the Building, the Building's structural framing system, bearing locations and related installation conditions. Begin installing Trusses only after any unsatisfactory conditions have been corrected.
- Properly connect all beams and components that support Trusses prior to installing the Trusses.
- Girder Trusses may consist of more than one Truss. Review the Truss Design Drawings to determine the proper number of plies and the correct attachment methods to be used at the jobsite.
- Use a Spreader Bar 1/2 to 2/3 of the Truss Span for Trusses over 30' and less than 60' and 2/3 to 3/4 of the Truss Span for Trusses up to and over 60'.
- Install Lateral Restraint and Diagonal Bracing in accordance with the guidelines in the JOBSITE PACKAGE to prevent Trusses from toppling during installation. Erect Trusses using the design spacing indicated, keeping the Trusses vertical and parallel to one another. Anchor Trusses securely at bearing points. Space Trusses no more than plus or minus 1/4" from Truss Placement Diagram location.
- Refer to the Construction Documents or the Truss Placement Diagram (if/when required by Contract) for the hanger locations. Hangers shall be correctly attached. Refer to hanger manufacturer's specifications for installation information.
- Install all Permanent Individual Truss Member Restraint or member reinforcement depicted on the Truss Design Drawings.
- Comply with the Owner's, or the Owner's retained Registered Design Professional's Permanent Building Stability Bracing, Anchorage, Connections and field assembly requirements. This information is typically provided in the Construction Documents.
- Install Structural Sheathing as soon as possible. Trusses hold their profiles best when they have been properly plumbed, restrained and braced with Structural Sheathing. **Sheath early... sheath often!**
- During construction, distribute material and equipment loads (e.g., plywood, drywall, roofing, tools, etc.) on the Trusses to

# Building Component Safety Information

stay within the limits of the carrying capacity for each Truss. Make sure the Trusses are adequately restrained and braced BEFORE placing any Construction Loads on them. Only install HVAC units, fire sprinklers, etc., on Trusses if the Trusses have been designed to accommodate these specific loads. Review the Truss Design Drawings for the assumed loads and locations.

**NOTE:** Temporarily braced structures are NOT suitable for use or occupancy. Restrict access to construction personnel only. DO NOT inhabit or store anything of value in temporarily braced structures.

## BUILDING DESIGNER INFORMATION

The following information is provided to help guide the Building Designer when using Trusses.

There are two situations under which building construction is performed:

1. Structures that require a Registered Design Professional (RDP)
2. Structures that DO NOT require a RDP

For Structures that require a RDP, the Building Designer is defined as:

The Registered Design Professional who contracts with the Owner for the design of the Framing Structural System and/or who is responsible for the preparation of the Construction Documents.

For Structures that DO NOT require a RDP, the Building Designer is defined as:

The Owner of the Building or the person that contracts with the Owner for the design of the Framing Structural System and/or who is responsible for the preparation of the Construction Documents.

## BUILDING DESIGNER CHECKLIST

### *Required Information in the Construction Documents*

Be sure to specify the following in the Construction Documents:

- Trusses with clear spans of 60' or greater require that the Owner contract with a Registered Design Professional for the design of the Temporary Installation Restraint/Bracing and the Permanent Individual Truss Member Restraint/Bracing.
- Trusses with clear spans of 60' or greater require that the Owner contract with a Registered Design Professional to provide special inspections to assure that the Temporary Installation Restraint/Bracing and the Permanent Individual Truss Member Restraint/Bracing is installed properly.

The following information is required in the Construction Documents for developing the design of the Trusses for the Building:

- All Truss and Structural Element orientations and locations
- Information to fully determine all Truss profiles
- All Structural Element and Truss support locations and bearing conditions (including the allowable bearing stress)
- The location, direction, and magnitude of all dead, live, and lateral Loads applicable to each Truss including, but not limited to, Loads attributable to: roof, floor, partition, mechanical, fire sprinkler, attic storage, rain and ponding, wind, snow (including snow drift and unbalanced snow), seismic, and any other Loads on the Truss.
- All Anchorage designs required to resist uplift, gravity, and lateral loads
- Truss-to-Structural-Element Connections, but not Truss-to-Truss Connections
- Permanent Building Stability Bracing, including Truss Anchorage Connections to the Permanent Building Stability Bracing
- Criteria related to serviceability issues including:
  - Allowable vertical, horizontal or other required deflection criteria
  - Any dead Load, Live Load and in-service creep deflection criteria for flat roofs subject to ponding loads
  - Any Truss camber requirements
  - Any differential deflection criteria from Truss-to-Truss or Truss to adjacent structural member
  - Any deflection and vibration criteria for floor Trusses including:
    - Any strongback bridging requirements
    - Any dead Load, Live Load, and in-service creep deflection criteria for floor Trusses supporting stone or ceramic tile finishes
  - Moisture, temperature, corrosive chemicals and gases expected to result in:
    - Wood moisture content exceeding 19 percent
    - Sustained temperatures exceeding 150 degrees F,
    - Corrosion potential from wood preservatives or other sources that may be detrimental to Trusses

### *Method of Restraint*

The method of Permanent Individual Truss Member Restraint/Bracing and the method of Anchoring or restraining to prevent lateral movement of all Truss members acting together as a system shall be accomplished by:

- Standard Industry Details** - Standard industry Lateral Restraint and Diagonal Bracing details in accordance with **BCSI-B3: Permanent Restraint/Bracing of Chords and Web Members** and **BCSI-B7: Temporary and Permanent Restraint/Bracing of 3x2 and 4x2 Parallel Chord Trusses** of the *Building Component Safety Information (BCSI)*.
- Substitution with Reinforcement** - Permanent Individual Truss Member Restraint shall be permitted to be replaced with reinforcement designed to prevent buckling (e.g., buckling reinforcement by T-Reinforcement, Scab Reinforcement, L-Reinforcement, proprietary reinforcement, etc.).
- Project-Specific Design** - A project-specific Truss member Permanent Lateral Restraint/Bracing design for the roof or floor Framing Structural System shall be permitted to be specified by any Registered Design Professional.

The method of Permanent Individual Truss Member Restraint and Diagonal Bracing for the Truss Top Chord, Bottom Chord and web members shall be permitted to be specified by any Registered Design Professional.

If a specific Permanent Bracing design for the roof or floor Framing Structural System is not provided by the Owner or any Registered Design Professional, the method of Permanent Individual Truss Member Restraint and Diagonal Bracing for the Truss Top Chord, Bottom Chord and web members shall be in accordance with **BCSI-B3** or **BCSI-B7**.

**Note:** This section on Method of Restraint is based on the provisions for wood Trusses as provided in Section 2303.4 of the *2012 International Building Code® (IBC®)*. The text provided here is taken directly from Section 2.3.3.1 of ANSI/TPI 1-2007, *National Design Standard for Metal Plate Connected Wood Truss Construction*.



## ACRONYMS AND INITIALISMS

---

**BCTLR:** Bottom Chord Temporary Lateral Restraint

**BCPLR:** Bottom Chord Permanent Lateral Restraint

**BCSI:** Building Component Safety Information

**BCSI B Series Summary Sheet:** Building Component Safety Information Series Summary Sheet

**CLB:** Continuous Lateral Brace

**CLR:** Continuous Lateral Restraint

**O.C.:** On-center (spacing)

**OSHA:** Occupational Safety & Health Administration

**PBSB:** Permanent Building Stability Bracing

**PCT:** Parallel Chord Trusses

**PITMR:** Permanent Individual Truss Member Restraint

**PSF:** Pounds per Square Foot

**RDP:** Registered Design Professional

**SBCA:** Structural Building Components Association

**TCTLR:** Top Chord Temporary Lateral Restraint

**TDD:** Truss Design Drawing

**TPD:** Truss Placement Diagram

**TPI:** Truss Plate Institute

## GUIDE FOR HANDLING, INSTALLING, RESTRAINING & BRACING OF TRUSSES

In order to properly receive, store, erect, brace, connect and integrate the Trusses into the Framing Structural System, it is necessary to have a complete understanding of the Submittal Documents for the project. Submittal Documents typically include, but are not limited to:

- the Construction Documents (i.e., architectural/structural plans and specifications)
- the Truss Submittal Package, which includes:
  - the Truss Design Drawings (TDD)
  - the Truss Placement Diagram(s) (if/when required by the Contract)
- this BCSI document and/or B-Series Summary Sheets (when provided)
- the erection and installation plan (if provided)
- site-specific conditions

The 2012 IBC and IRC include general provisions for the typical submittal process in Sections 107 and R106, respectively. Some of the more pertinent subsections include, in part:

### IBC

**107.1 General.** Submittal documents consisting of *construction documents*, statement of *special inspections*, geotechnical report and other data shall be submitted in two or more sets with each *permit* application. The *construction documents* shall be prepared by a *registered design professional* where required by the statutes of the jurisdiction in which the project is to be constructed...

**107.2 Construction documents.** *Construction documents* shall be in accordance with Sections 107.2.1 through 107.2.5.

**107.2.1 Information on construction documents.** *Construction documents* shall be dimensioned and drawn upon suitable material. Electronic media documents are permitted to be submitted when *approved by the building official*. *Construction documents* shall be of sufficient clarity to indicate the location, nature and extent of the work proposed and show in detail that it will conform to the provisions of this code and relevant laws, ordinances, rules and regulations, as determined by the *building official*.

**107.3.4 Design professional in responsible charge.** When it is required that documents be prepared by a *registered design professional*, the *building official* shall be authorized to require the *owner* to engage and designate on the building *permit* application a *registered design professional* who shall act as the *registered design professional in responsible charge*...

The *registered design professional in responsible charge* shall be responsible for reviewing and coordinating submittal documents prepared by others, including phased and deferred submittal items, for compatibility with the design of the building.

**1603.1 General.** *Construction documents* shall show the size, section and relative locations of structural members with floor levels, column centers and offsets dimensioned. The design loads and other information pertinent to the structural design required by Sections 1603.1.1 through 1603.1.9 shall be indicated on the *construction documents*.

### IRC

**R106.1 Submittal documents.** Submittal documents consisting of *construction documents*, and other data shall be submitted in two or more sets with each application for a *permit*. The *construction documents* shall be prepared by a *registered design professional* where required by the statutes of the *jurisdiction* in which the project is to be constructed. Where special conditions exist, the *building official* is authorized to require additional *construction documents* to be prepared by a *registered design professional*.

**Exception:** The *building official* is authorized to waive the submission of *construction documents* and other data not required to be prepared by a *registered design professional* if it is found that the nature of the work applied for is such that reviewing of *construction documents* is not necessary to obtain compliance with this code.

**R106.1.1 Information on construction documents.** *Construction documents* shall be drawn upon suitable material. Electronic media documents are permitted to be submitted when *approved by the building official*. *Construction documents* shall be of sufficient clarity to indicate the location, nature and extent of the work proposed and show in detail that it will conform to the provisions of this code and relevant laws, ordinances, rules and regulations, as determined by the *building official*...

**R106.1.2 Manufacturer's installation instructions.** Manufacturer's installation instructions, as required by this code, shall be available on the jobsite at the time of inspection.

**R106.3.3 Phased approval.** The *building official* is authorized to issue a *permit* for the construction of foundations or any other part of a building or structure before the *construction documents* for the whole building or structure have been submitted, provided that adequate information and detailed statements have been filed complying with pertinent requirements

of this code. The holder of such *permit* for the foundation or other parts of a building or structure shall proceed at the holder's own risk with the building operation and without assurance that a *permit* for the entire structure will be granted.

**R106.4 Amended construction documents.** Work shall be installed in accordance with the *approved construction documents*, and any changes made during construction that are not in compliance with the *approved construction documents* shall be resubmitted for approval as an amended set of *construction documents*.

The Construction Documents are critical for understanding how the building is to be built. The Construction Documents shall be readily available on the jobsite and only the approved set shall be used.

All of the care and quality involved in the design and manufacture of Trusses is jeopardized if the Trusses are not properly handled, hoisted, installed, restrained and braced.

**WARNING** The consequences of improper handling, erecting, installing, restraining and Bracing can result in a collapse of the structure, which, at best, is a substantial loss of time and materials, but can also result in serious injury and/or loss of life. The majority of Truss accidents occur during Truss installation and not as a result of improper design or manufacture.



PHOTO B1-1

Prior to Truss erection/installation, it is strongly recommended that the Contractor involved with the erection/installation of the Trusses meet with the erection/installation crew and crane operator for a safety and planning meeting; making sure each crew member understands his or her roles and responsibilities during the erection/installation process.

**CAUTION** Exercise care when removing banding and handling Trusses to avoid damaging Trusses and prevent injury. Wear personal protective equipment for the eyes, feet, hands and head when working with Trusses.

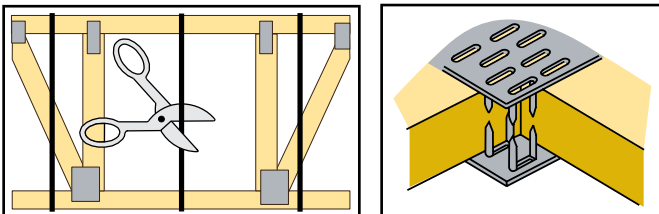


FIGURE B1-1

## TEMPORARY INSTALLATION RESTRAINT/BRACING

Trusses are not marked in any way to identify the frequency or location of Temporary Installation Restraint/Bracing.

**NOTICE** All Temporary Installation Restraint/Bracing shall comply with the recommendations and options as described herein and/or in the latest edition of the individual B-Series Summary Sheets that are referenced.

## PERMANENT INDIVIDUAL TRUSS MEMBER RESTRAINT

Permanent Individual Truss Member Restraint (PITMR) shall be undertaken in accordance with **BCSI-B3** or the Building Designer's Permanent Building Stability Bracing (PBSB) plan, which must include all Bracing that is considered part of the lateral force resisting system for the entire Building. The PBSB is Bracing that transfers forces due to gravity, seismic, wind, and/or other external lateral forces, as well as collected forces caused by the restraint of members subject to buckling, into the shear walls, foundation or other lateral force resisting systems that are provided for the Building.

Some standard industry restraint and Bracing details are included in **BCSI-B3** and on the SBCA website at [sbcindustry.com](http://sbcindustry.com) where several DXF/DWG details are provided to aid in tending to the wide variety of field situations that arise and to provide greater uniformity of detailing.

The locations for attaching Continuous Lateral Restraint (a type of PITMR) to individual compression members of a Truss are provided on the TDD. Bracing such as Diagonal Bracing is required for the Continuous Lateral Restraint (CLR) to prevent the simultaneous buckling of the series of Truss members to which the CLR is attached. Permanent Lateral Restraint and Diagonal Bracing are required for proper performance of individual Trusses within the roof or floor system. Permanent Lateral Restraint and Diagonal Bracing shall provide sufficient support at right angles to the plane of the Truss to hold every Truss member in the position assumed for it to properly carry the applied design loads. **If properly planned, the Temporary Installation Restraint/Bracing applied during Truss installation can be used as permanent Lateral Restraint and Diagonal Bracing, making the completion of the permanent Lateral Restraint and Diagonal Bracing more efficient.**

Finally as indicated in Section 2303.4.4 of the 2012 IBC, the Registered Design Professional (RDP) (or where there is no RDP, the Building Designer [see Chapter 2 of *ANSI/TPI 1*]) is responsible for the proper transfer of design Loads and the Anchorage design of each Truss to the supporting structure. When the flow of Loads has been accounted for and all the Load resisting systems for the Building have been adequately designed, constructed and installed, the structural framing for the Building is complete.



## SPECIAL DESIGN REQUIREMENTS

Special design requirements, such as wind Bracing, portal Bracing, seismic Bracing, Diaphragms, shear walls, or other Load transfer elements and their Connections to Trusses shall be considered separately by the Building Designer, who shall determine the size, location, and method of Connections for all Bracing as needed to resist these forces.

## UNLOADING & LIFTING

**NOTICE** Avoid Lateral Bending  
(See Figure B1-5, page 4.)

- ✓ Beginning with the unloading process, and throughout all phases of construction, exercise care to avoid LATERAL BENDING of Trusses, which can cause damage to the lumber and Metal Connector Plates.

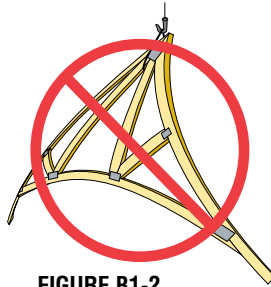


FIGURE B1-2

- ✓ Due to treatment effects, fire retardant treated Trusses require special care when handling to prevent chord and web member breakage. Limit exposure to the elements per manufacturer's recommendations.

## JOBSITE HANDLING

- ✓ Make sure Trusses in a bundle are securely connected together prior to moving.
- ⊘ **DO NOT** rely on banding to securely transfer bundles on the jobsite.
- ✓ Banded Truss bundles, in a vertical position, should be picked up along the Top Chords.



PHOTO B1-2



PHOTO B1-3

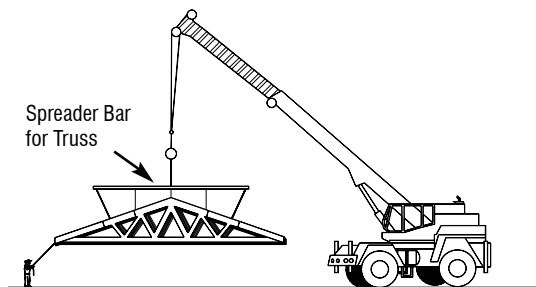


FIGURE B1-3

- ✓ Proper banding and smooth ground allow for unloading of Truss bundles without damage. Trusses should be unloaded as close to the Building site as possible to minimize handling. **USE CARE TO NOT DAMAGE TRUSSES WITH THE FORKS OF THE FORKLIFT.**

- ⊘ **DO NOT** break banding until erection/installation begins.
- ⊘ **DO NOT** drag or push Trusses along ground.
- ⊘ **DO NOT** lift banded Trusses by the banding.
- ⊘ **DO NOT** store unbraced bundles upright.



PHOTO B1-4

- ⊘ **DO NOT** store Trusses on uneven ground.



PHOTO B1-5

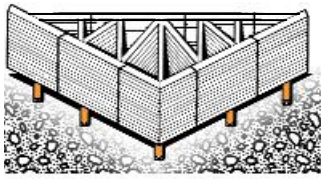
- ✓ If Trusses are stored vertically, they shall be braced in a manner that will prevent tipping or toppling.



PHOTO B1-6

- ⚠ **CAUTION** Exercise care when removing banding to avoid damaging Trusses and prevent personal injury. Gloves and safety glasses should be worn.

- ✓ Trusses may be unloaded directly on the ground at the time of delivery or stored temporarily in contact with the ground after delivery. If Trusses are to be stored horizontally for more than one week, place Blocking of sufficient height beneath the stack of Trusses on 8' to 10' intervals (or as required) to minimize Lateral Bending and to lessen moisture gain from the ground (See Figure B1-4, page 4).



**FIGURE B1-4**

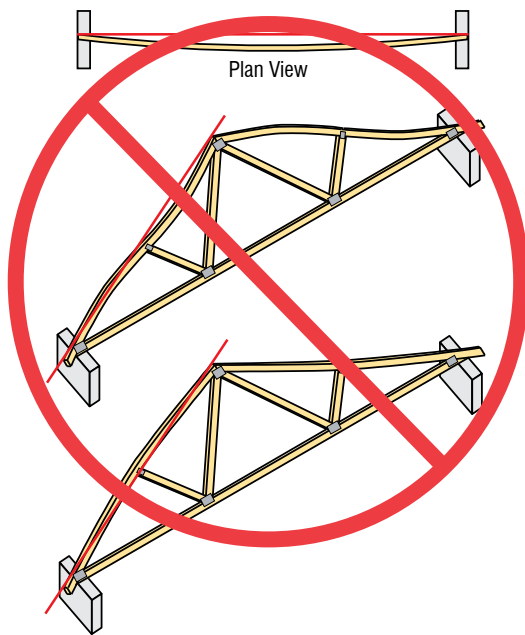
Trusses stored for more than one week shall be protected from the environment in a manner that provides adequate ventilation of the Trusses. If tarpaulins or other protective covers are used,

the ends shall be left open for ventilation. Tight-fitting coverings are not recommended, since they can trap moisture.

**NOTICE** Avoid Lateral Bending

- ✓ Trusses are relatively deep, narrow Structural Building Components that are extremely flexible if bent perpendicular to their plane. Use care when handling Trusses to limit the amount of Lateral Bending, which can cause damage to the lumber and/or plates.

**Examples of Lateral Bending to be minimized when handling Trusses**  
(red line added to illustrate deviation from plane)



**FIGURE B1-5**

## CRANE USE & PROPER TRUSS HANDLING

A common method for hoisting Trusses into place is to use a crane and rigging. Inadequate or improperly used hoisting equipment can result in damage to Truss members and/or connector plates. This section provides very basic guidelines to help avoid this type of damage.



Spreader Bar used is too short for this Truss.

**PHOTO B1-7**



**PHOTO B1-8**

## Responsibility

Crane equipment and use should comply with OSHA standards and, unless agreed to expressly through Contract, is the responsibility of the crane operator and/or Contractor. All OSHA standards referred to in this document can be found on the OSHA website at [osha.gov/cranes-derricks/index.html](http://osha.gov/cranes-derricks/index.html).

## Key Considerations

- Always obtain the correct crane size; never exceed load capacity.
- Always properly stabilize the crane onsite.
- Always use proper rigging equipment.
- Use special hoisting equipment as needed. See hoisting recommendations for Truss bundles (page 6) or single Trusses (page 8).
- Crane operator and ground crew need to know basic hand signals (see examples in Figure B1-6, page 5).

## Crane Size

Crane size should be determined with consideration for both size and weight of the Trusses to be hoisted, as well as the total distance from the crane footing location(s) to the farthest point of Truss delivery. Crane equipment, load capacity, and use should comply with OSHA standards [Subpart CC, 29 CFR 1926.1400]. This standard requires the crane user to comply with the equipment manufacturer's specifications and limitations applicable to the operation of the crane. It also states that when the manufacturer's specifications are not available, equipment limitations should be determined and documented by a Registered Design Professional competent in this field.

## Crane Setup & Inspection

It is essential the crane is properly stabilized, physical obstructions to movement are accounted for, and proximity of electrical power lines is known. The crane footing area should be level, firm, properly graded, free from obstruction, and drained to prevent settling and tipping.

Outriggers should always be extended and used in accordance with crane manufacturer's recommendations. Place blocking under outrigger pads to spread the load to the ground over a larger area to prevent the pad from sinking. The relationship between the weight of the load, the angle of the boom, and the hoisting process shall be considered to prevent tipping. Consult the crane manufacturer's load and angle information prior to hoisting.

When uncertain about proper crane setup, consult a qualified Registered Design Professional competent in this field to ensure setup complies with the standards established by the American Society of Mechanical Engineers [ANSI/ASME B30.5-2007].

As required by OSHA standard [Subpart CC, 29 CFR 1926.1412-1413], all crane and rigging equipment should be inspected regularly by a competent individual to ensure everything is in proper working order and that any worn or defective parts are repaired or replaced. Equipment and worksite inspections should adhere to the latest "Mobile Crane Inspection Guidelines for OSHA Compliance Officers" published by OSHA.

## Load Positioning & Movement

Position the load to be hoisted as close to the Building site as possible to minimize hoisting distance. Load movement using crane equipment and rigging should comply with OSHA regulations [Subpart CC, 29 CFR 1926.1417].

**NOTICE** Check Truss bundle banding prior to moving bundles.

**DO NOT** rely on banding to hoist and move bundles on the jobsite.

## Rigging Equipment

Use materials such as slings, chains, cables and nylon straps of sufficient strength to carry the weight of the Truss or Truss bundle. Use slings, taglines and Spreader Bars properly to avoid damage to the Truss members and Connections.

All rigging equipment and use should comply with OSHA regulations [Subpart CC, 29 CFR 1926.1425], which provides guidelines on safe working loads permitted for the different types of rigging equipment. This standard also requires regular inspection of all rigging equipment by a competent individual and replacement or repair of damaged or defective parts.

## Hoisting Trusses

**NOTICE** Avoid Lateral Bending when hoisting Trusses (see Figure B1-7).

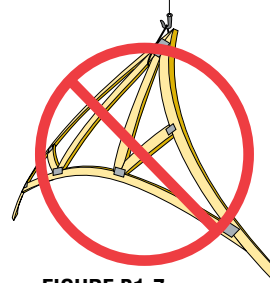


FIGURE B1-7

## BASIC HAND SIGNALS

<b>RAISE BOOM:</b> Arm extended, fingers closed, thumb pointing upward.	<b>EXTEND BOOM:</b> (Telescoping booms). Both fists in front of body with thumbs pointing outward.	<b>HOIST:</b> With forearm vertical, forefinger pointing up, move hand in small horizontal circle.	<b>MOVE SLOWLY:</b> Use one hand to give any motion signal and place the other hand motionless in front of the hand giving the signal.
<b>LOWER BOOM:</b> Arm extended, fingers closed, thumb pointing downward.	<b>RETRACT BOOM:</b> (Telescoping booms). Both fists in front of body with thumbs pointing toward each other.	<b>LOWER:</b> With arm extended downward, forefinger pointing down, move hand in small horizontal circle.	<b>STOP:</b> Arm extended, palm down, move arm back and forth horizontally.

FIGURE B1-6

**NOTICE** Do not lift single Trusses by the peak using a hook as shown in Figure B1-8A, as this can cause damage to the chords, Webs and/or Truss Plates.

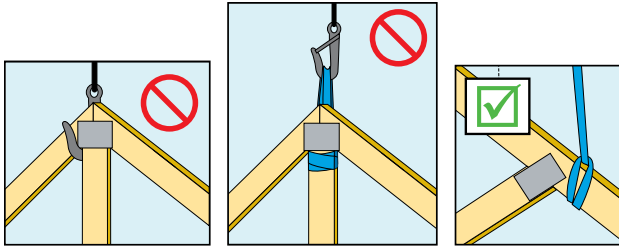


FIGURE B1-8A

FIGURE B1-8B

FIGURE B1-8C

**NOTICE** Do not lift single Trusses by the Webs as shown in Figure B1-8B, as this will cause Lateral Bending in the Truss and damage to the Truss Plates and web member.

**NOTICE** Connect lifting devices to the Truss Top Chord with only closed-loop attachments (see Figure B1-8C). Refer to the section entitled “Mechanical Hoisting Recommendations for Single Trusses” beginning on page 8 for additional information regarding the correct hoisting methods for single Trusses of various span lengths.

**NOTICE** A Spreader Bar used to hoist a Truss shall be of sufficient strength and rigidity to carry the weight and to resist bending of the Truss. Spreader Bars should comply with design specifications established by ASME [ANSI/ASME B30.5-2007] and prescribed by the equipment manufacturer.

## Special Considerations

- Use special care in adverse weather conditions. Buildings under construction become more dangerous when constructed in high-wind conditions. Lightning can also pose a serious risk. It is the responsibility of the crane operator or Contractor to recognize adverse weather conditions and take prompt and appropriate action to ensure safety.
- Avoid using a crane in close proximity to electrical power lines unless the power has been disconnected by the local power company [OSHA: 29 CFR 1926.1407-1411].
- If you are using a crane within five miles of an airport, contact the airport 30 days prior to crane use to learn about any required safety regulations [FAA: 14 CFR Part 77].

## HOISTING & PLACEMENT OF TRUSS BUNDLES

Trusses that have been banded securely together to form a bundle are stiffer than single Trusses; therefore, hoisting recommendations for bundles are different as there is less likelihood of damage due to out-of-plane bending (see Photo B1-9).



PHOTO B1-9

## Recommendations for Hoisting Truss Bundles

**NOTICE** Determine the weight of the Truss bundle. The actual unit weight of a Truss depends on many factors including the size and species of lumber, the moisture content of the lumber and the Truss configuration. A good rule to estimate the weight of the bundle is to use 15 pounds per foot of Truss length times the number of Trusses in the bundle.

**NOTICE** Know the crane's capacity. Do not lift bundles that weigh more than the crane's capacity, which varies considerably with the length and angle of the boom.

- Before lifting, inspect the banding to make sure it is secure and intact. NEVER use the banding to lift the bundles.
- If a large bundle is made of several smaller bundles, break the large bundle bands and lift the smaller banded bundles one at a time.



PHOTO B1-10

## BCSI-B1: Guide for Handling, Installing, Restraining & Bracing of Trusses

- Lift points for hoisting Truss bundles are permitted anywhere along the chords.
- A single lift point is acceptable for bundles with Top Chord Pitch Trusses that are no more than 45' in length (see Photo B1-11) and Parallel Chord Trusses that are no more than 30' in length.



PHOTO B1-11

- Use at least two lift points for bundles with Top Chord Pitch Trusses up to 60' (see Photo B1-12) and Parallel Chord Trusses up to 45' in length.



PHOTO B1-12

- Use at least three lift points for bundles with Top Chord Pitch Trusses greater than 60' and Parallel Chord Trusses greater than 45'.
- Follow the recommendations for proper crane use, tag lines, and all rigging equipment as described in this document. Special care shall be taken in the choice of rigging equipment to prevent damage to the Trusses.
- Place Truss bundles in their most stable configuration or securely support by temporary means to ensure the safe removal of banding and installation of individual Trusses.
- Use care to position Truss bundles so that the supporting structure is not overloaded.
- Support each bundle with as many exterior and interior walls as possible.
- All walls shall be adequately braced and capable of supporting the weight of the bundle. Install additional studs or full-height T-Reinforcement to existing studs, if necessary, in the vicinity of the bundle.

- Take additional precautions if Truss bundles cantilever over outside walls. Do not cantilever the bundle more than 1/3 the overall length of the Trusses. Use extra caution when removing banding of cantilevered bundles.



PHOTO B1-13

- Take extra care with bundles of shallow or vaulted Trusses, which can bend excessively if they are not adequately supported.



PHOTO B1-14

- Bundles placed vertically shall be adequately braced or supported to prevent toppling. In Photo B1-15, the crew used a second-story wall for support.



PHOTO B1-15

- Do not stand on flat Truss bundles once they are placed on top of walls.
- Remove banding carefully and proceed with Truss erection and Bracing.

## MECHANICAL HOISTING RECOMMENDATIONS FOR SINGLE TRUSSES

- ✓ Use the erection equipment to safely hold the erected Truss in position until such time as all Top Chord Temporary Lateral Restraint (TCTLR) has been installed and the Trusses are securely fastened to all bearing points assumed in the design.

**NOTICE** Using a single pick-point at the peak can damage the Truss.

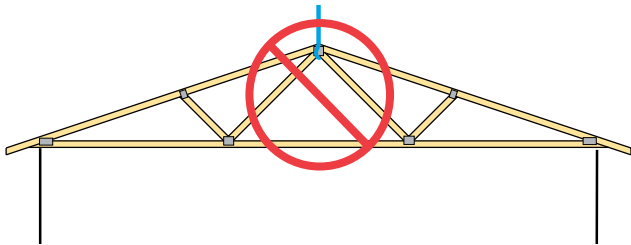


FIGURE B1-9

**NOTICE** The Contractor should provide adequate rigging (crane, forklift, slings, taglines, Spreader Bars) for sufficient control during lifting and placement to assure safety to personnel and to prevent damage to Trusses and property. Slings, taglines, and Spreader Bars should be used in a manner that will not cause any damage to the Metal Connector Plates and Truss lumber. Lifting devices should be connected to the Truss Top Chord with only a closed loop attachment utilizing materials such as slings, chains, cables or nylon straps of sufficient strength to carry the weight of the Truss.

**NOTICE** Avoid Lateral Bending (see Figure B1-5, page 4).

**TRUSSES UP TO 30':** For single Trusses up to 30', use a minimum of two pick-points near Top Chord joints spaced up to 1/2 the Truss length apart. Keep line angle to 60° or less.

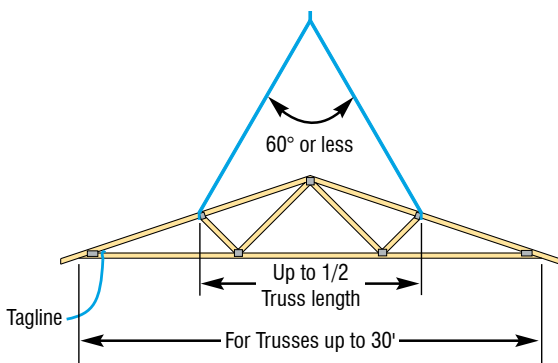


FIGURE B1-10A

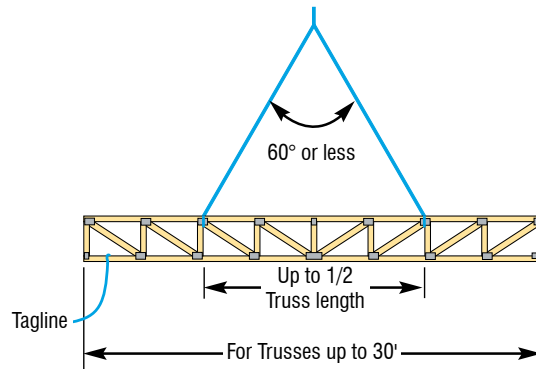


FIGURE B1-10B

**TRUSSES UP TO 60':** For single Trusses between 30' and 60', use a Spreader Bar 1/2 to 2/3 of the Truss length. Attach Truss to the Spreader Bar with lines that slope inward or “toe-in,” as shown.

**CAUTION** Lines that “toe-out” can cause the Truss to buckle.

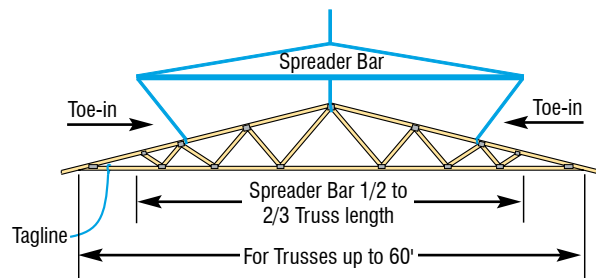


FIGURE B1-11A

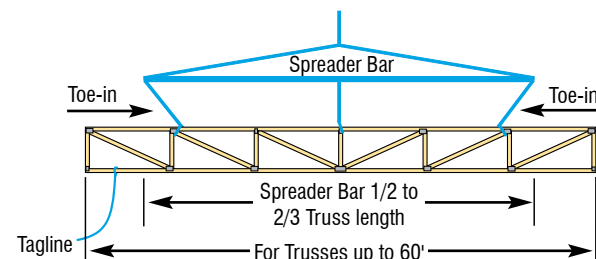
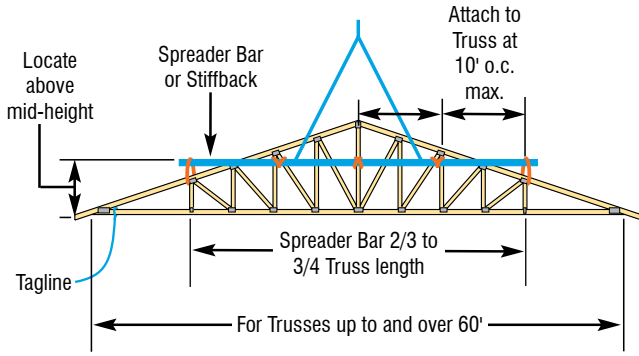


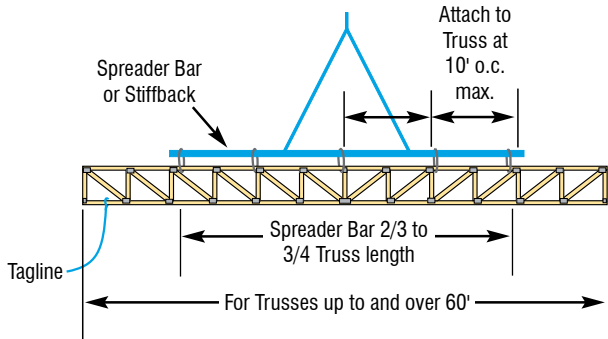
FIGURE B1-11B

**TRUSSES UP TO AND OVER 60':** For single Trusses over 60', use a Spreader Bar 2/3 to 3/4 of the Truss length. The Spreader Bar prevents Lateral Bending and should be attached to Top Chords and Webs at 10' intervals. Locate the Spreader Bar at or above mid-height of the Truss to prevent overturning.

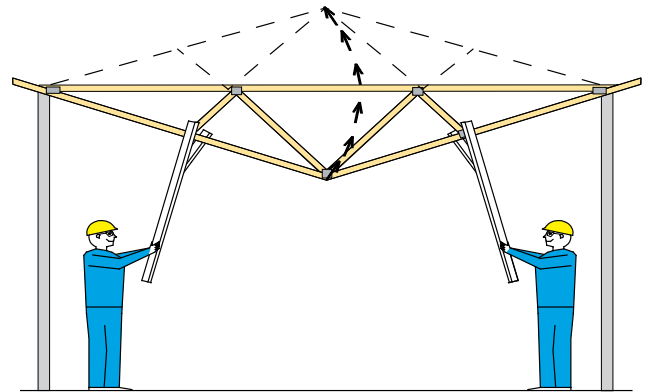
**NOTICE** Design the Spreader Bar of any material with sufficient strength and rigidity to carry the weight and to resist bending of the Truss. If in doubt, seek professional guidance.



**FIGURE B1-12A**



**FIGURE B1-12B**



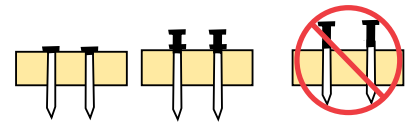
**FIGURE B1-14**

**RESTRAINT/BRACING MATERIAL & CONNECTIONS**

**⚠ CAUTION** Inadequate size and/or fastening of Bracing material is a major cause of erection dominoing.

Minimum size of lumber used as Lateral Restraint and Diagonal Bracing is 2x4 stress-graded lumber, unless another size is specified by the Building Designer.

Minimum Nail Size
10d (0.128x3")
12d (0.128x3.25")
16d (0.131x3.5")



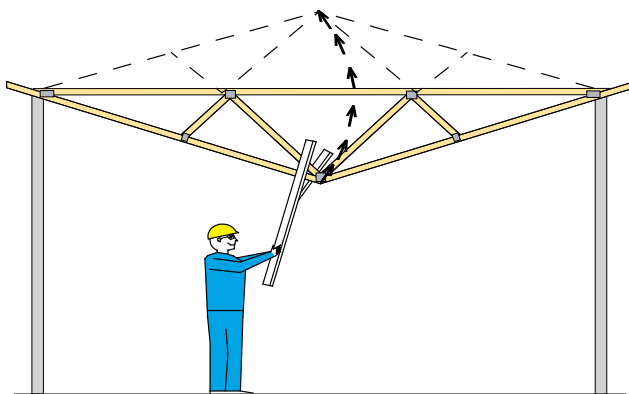
**TABLE B1-1**

See note below for number of nails.

**FIGURE B1-15**

**INSTALLATION OF SINGLE TRUSSES BY HAND**

- ✓ Lifting by hand is allowed, provided excessive Lateral Bending is prevented (see Figure B1-5, page 4).
- ✓ Trusses with spans less than or equal to 20' can be raised into position by lifting near the peak.



**FIGURE B1-13**

- ✓ Trusses with spans less than or equal to 30' should be raised into position by lifting at Top Chord joints nearest the quarter points of the span.

## BEGINNING THE ERECTION/ INSTALLATION PROCESS (see BCSI-B2)

- It is important for the Contractor to provide substantial Bracing for the first Truss erected. Trusses making up the rest of the first set are tied to the first Truss and rely upon it for stability. Likewise, after this first set of Trusses is adequately Diagonally Braced, the remaining Trusses installed rely on this first set for stability. Performance of the Truss Bracing system depends to a great extent on how well the first set of Trusses is restrained and braced.

## GROUND BRACE - EXTERIOR (see BCSI-B2)

- Exterior Ground Bracing ties the first set of Trusses off to a series of braces that are attached to stakes driven into the ground and securely anchored. The Ground Brace itself should be restrained and braced as shown in Figures B1-16 and 17 or it is apt to buckle. Additional Ground Braces, placed inside the building in the opposite direction, are also recommended.
- Locate Ground Braces for the first Truss directly in line with all rows of Top Chord Temporary Lateral Restraint (TCTLR).

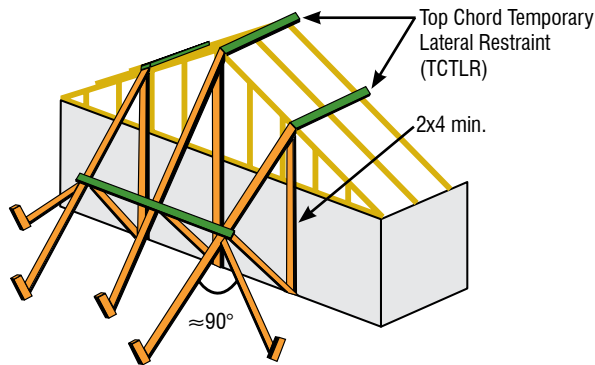


FIGURE B1-16

## GROUND BRACE - INTERIOR (See BCSI-B2)

- Where the height of the Building or ground conditions prohibit Bracing from the exterior, stabilize the first Truss with Ground Bracing attached to the interior at the floor level, provided the floor is capable of supporting the Ground Bracing forces. Install the first Truss near the middle of the Building and brace similar to Exterior Ground Bracing shown below. Restrain and Diagonally Brace the first set of Trusses before removing Ground Braces and setting remaining Trusses.

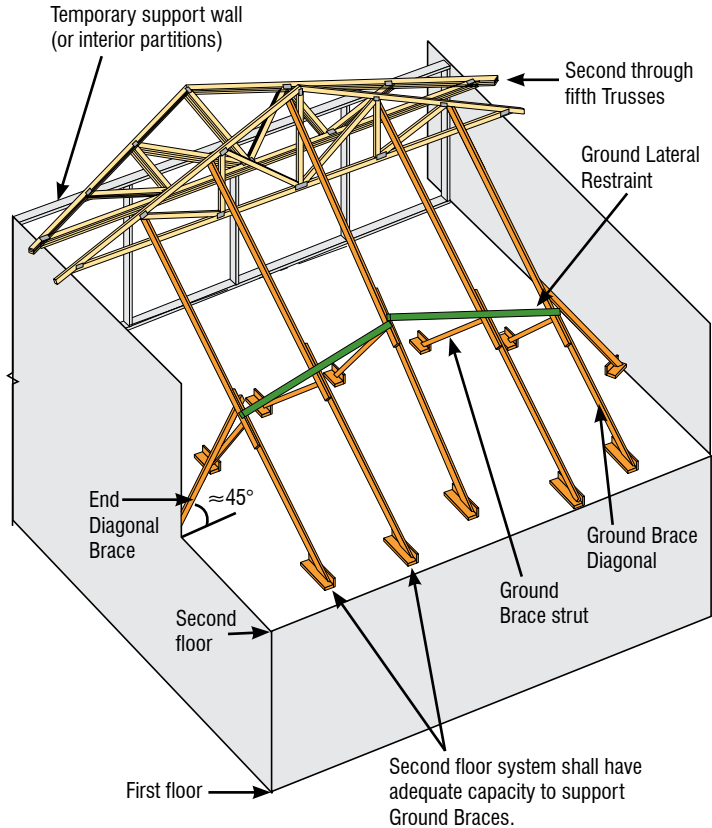


FIGURE B1-18

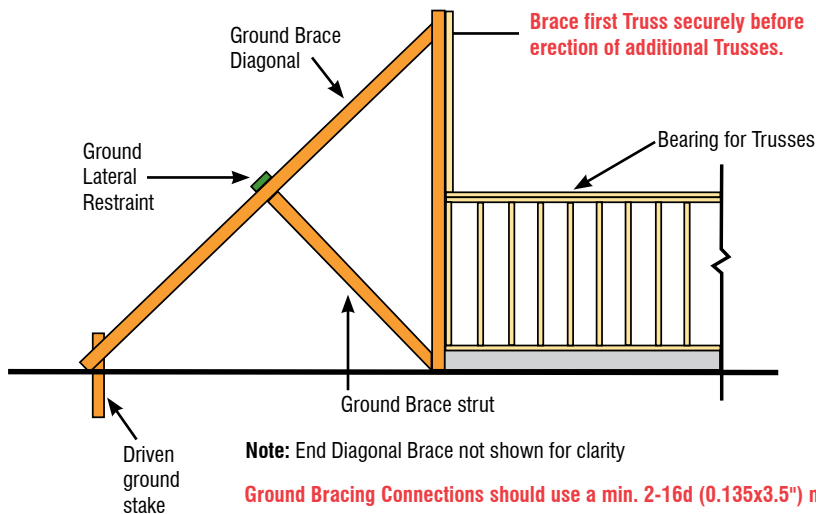


FIGURE B1-17



**INSTALLATION TOLERANCES**

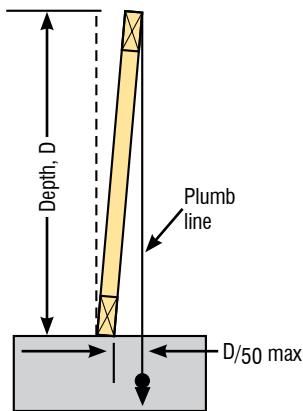


FIGURE B1-19

Out of Plumb	
D/50	D (ft.)
1/4"	1'
1/2"	2'
3/4"	3'
1"	4'
1-1/4"	5'
1-1/2"	6'
1-3/4"	7'
2"	≥8'

TABLE B1-2

**Note:** The tolerances shown apply to Trusses in their permanently set position and assume the Top Chords are adequately restrained and braced by the diaphragm.

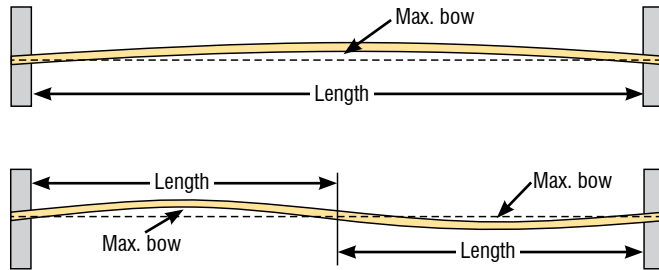


FIGURE B1-20

- ✓ Top Chord bearing flat or Parallel Chord Trusses shall be installed so that the gap between the inside edge of the bearing and the first diagonal or vertical web member does not exceed 1/2" (see Figure B7-3, page 59).

Out of Plane	
Max. Bow	Truss Length (feet-inches-sixteenths)
3/4"	12-6-0
7/8"	14-7-3
1"	16-8-6
1-1/8"	18-9-10
1-1/4"	20-9-10
1-3/8"	22-10-13
1-1/2"	25-0-0
1-3/4"	29-2-6
2"	≥33-3-10

TABLE B1-3

- ✓ COMPLIANCE WITH INSTALLATION TOLERANCES IS CRITICAL TO ACHIEVING AN ACCEPTABLE ROOF OR FLOOR LINE, AND TO ACCOMPLISHING EFFECTIVE BRACING. Setting Trusses within tolerance the first time prevents the need for the hazardous practice of re-spacing or adjusting Trusses when Structural Sheathing or Roof Purlins are installed. Leaning or bowing Trusses can result in nails that miss the Top Chords when Structural Sheathing is applied, and create excessive cumulative stresses on the Bracing, which can lead to Bracing failure and Truss dominoing.

- ✓ The spacing of Trusses along bearing support must be within +/- 1/4" of plan dimension. Field conditions that force spacing beyond this tolerance shall be reviewed and approved by the Building Designer and Truss Designer.

**RESTRAINT/BRACING WARNINGS**

- ⊘ DO NOT walk on unbraced Trusses.



FIGURE B1-21

- ⊘ DO NOT walk on Trusses or Gable End Frames lying flat.



FIGURE B1-22

- ✓ All anchors, hangers, tie-downs, seats, and bearing ledgers that are part of the supporting structure shall be accurately and properly placed and permanently attached before Truss erection/installation begins. Do not install Trusses on anchors, hangers, tie-downs, seats or bearing ledgers that have temporary Connections to the supporting structure. Properly connect the Truss to each support.

⚠ **WARNING** The structure is not structurally sound, stable or safe until all the hardware, restraints and Bracing are properly installed.

⚠ **WARNING LATERAL RESTRAINT & DIAGONAL BRACING ARE VERY IMPORTANT!**

**SEE BCSI-B2 FOR ADDITIONAL RESTRAINT/BRACING OPTIONS.**

**TEMPORARY INSTALLATION RESTRAINT/BRACING REQUIREMENTS FOR THE VARIOUS PLANES OF A ROOF TRUSS**

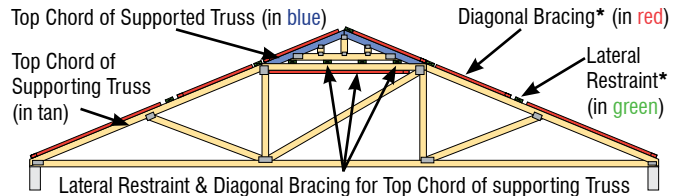
✓ Temporary Installation Restraint/Bracing must be applied to **ALL** of the following planes of the Trusses to ensure stability:

- 1) Top Chord Plane (roof plane)
- 2) Web Member Plane (sloping or vertical plane perpendicular to Trusses)
- 3) Bottom Chord Plane (ceiling plane)

⚠ **CAUTION** It is critical to install Lateral Restraint and Diagonal Bracing for the Top Chord and Web Member Plane immediately to prevent out-of-plane buckling of the Truss.

1) **TOP CHORD TEMPORARY INSTALLATION RESTRAINT/BRACING** is the most important step for the Contractor. Truss Top Chords are susceptible to lateral buckling. See **BCSI-B2** for more information.

✓ THE TOP CHORD LATERAL RESTRAINT AND DIAGONAL BRACING APPROACH PROVIDED BELOW APPLIES TO ALL SLOPING CHORD TRUSSES, SCISSORS TRUSSES, 2X PARALLEL CHORD TRUSSES AND PIGGYBACK TRUSSES. **Note:** 2x Trusses with depths less than 1/15th of the span at any location away from bearings require more complex Temporary Installation Restraint/Bracing. Consult a Registered Design Professional.



**FIGURE B1-23**

Lateral Restraint & Diagonal Bracing for Top Chord of supporting Truss directly beneath supported (Cap) Truss\*\*

\***Note:** Refer to Table B1-4 and Figures B1-24A and B1-24B for spacing of Temporary Lateral Restraint and Diagonal Bracing on the sloped Top Chords of the supported and supporting Truss.  
 \*\***Note:** Refer to TDD and Figure B3-47 on page 52 for spacing of permanent Lateral Restraint and Diagonal Bracing, respectively, on the flat portion of the supporting Truss or as specified in the Construction Documents.

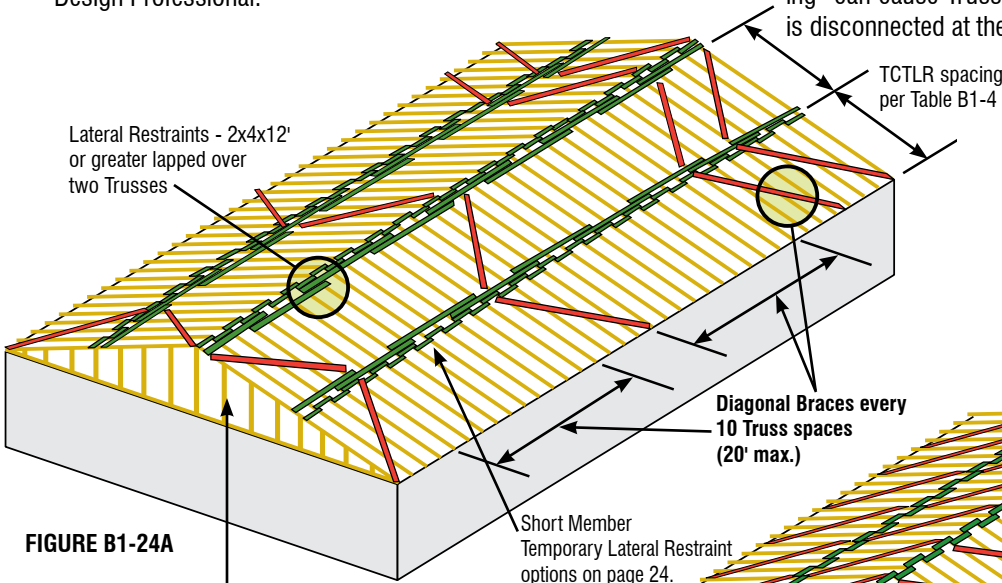
**Maximum Top Chord Temporary Lateral Restraint Spacing**

Truss Span	Top Chord Temporary Lateral Restraint (TCLR) Spacing
Up to 30'	10' on-center maximum
30' - 45'	8' on-center maximum
45' - 60'	6' on-center maximum
60' - 80' *	4' on-center maximum

\*Consult a Registered Design Professional for Trusses longer than 60'.

**TABLE B1-4**

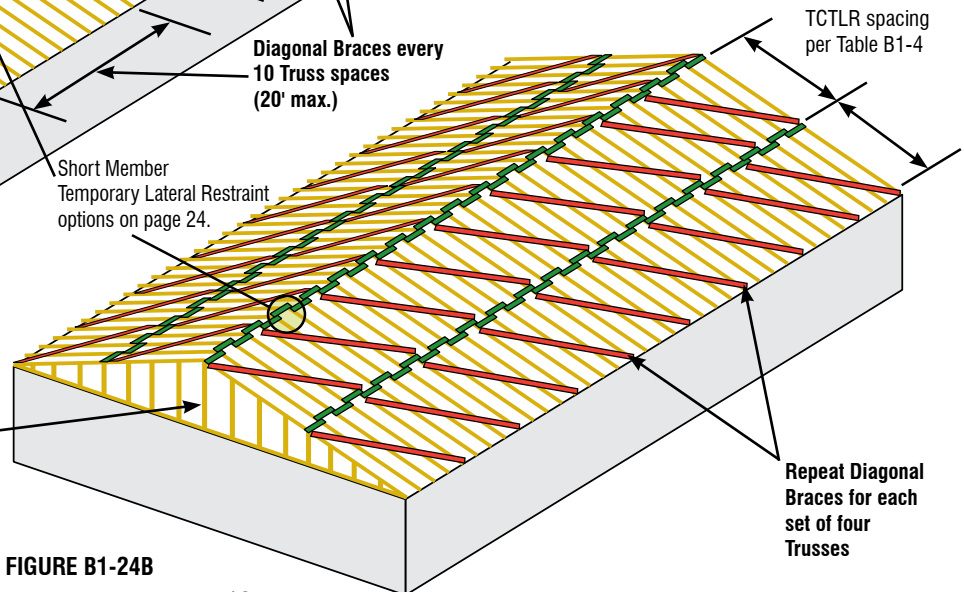
⚠ **WARNING** Exact spacing between Trusses should be maintained as the Lateral Restraint and Diagonal Bracing is installed to avoid the hazardous practice of trying to remove this material to adjust spacing. This act of “adjusting spacing” can cause Trusses to topple if the restraint and Bracing is disconnected at the wrong time.



**FIGURE B1-24A**

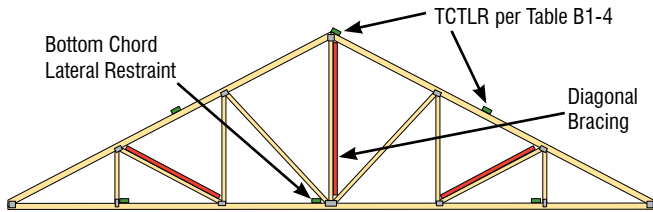
Ground Bracing not shown for clarity

**NOTICE** Refer to **BCSI-B3** for Gable End Frame Bracing



**FIGURE B1-24B**

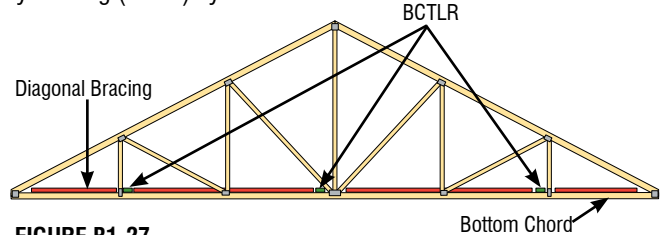
2) **WEB MEMBER PLANE** requires temporary/permanent Diagonal Bracing, such as shown in Figures B1-25 and 26, which is critical in preventing Trusses from leaning or dominoing. Install 2x Diagonal Bracing on Web members (vertical Webs whenever possible), at or near Bottom Chord Lateral Restraint. Structural Sheathing can be substituted. See **BCSI-B2** for additional information pertaining to Web Member Plane **Temporary** Diagonal Bracing and **BCSI-B3** for information pertaining to **Permanent** Restraint and Bracing for the Web Member Plane.



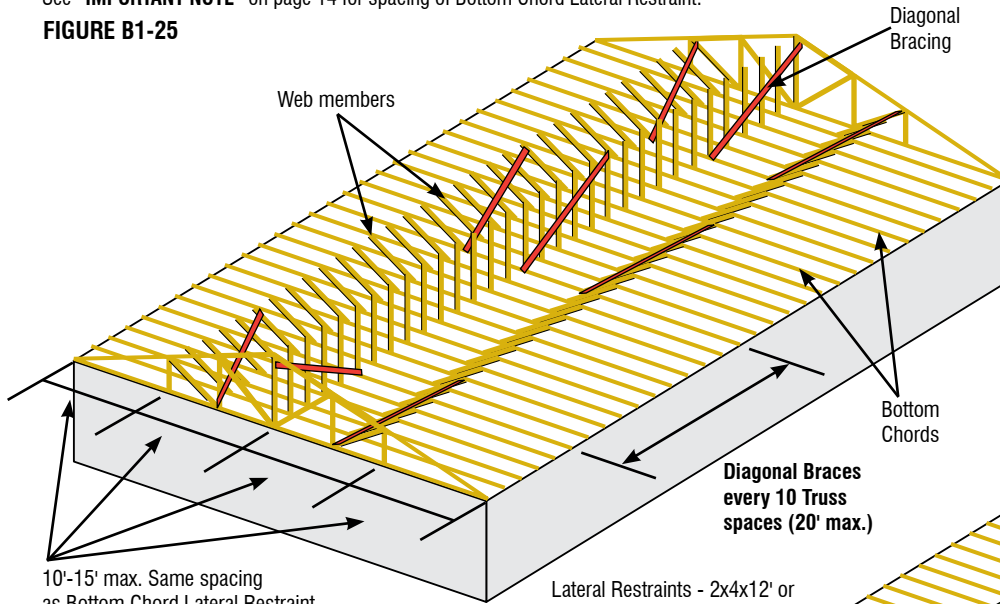
Apply Diagonal Bracing to Webs that are near the Bottom Chord Lateral Restraint. See "IMPORTANT NOTE" on page 14 for spacing of Bottom Chord Lateral Restraint.

**FIGURE B1-25**

3) **BOTTOM CHORD TEMPORARY LATERAL RESTRAINT (BCTLR) AND DIAGONAL BRACING** is required to maintain on-center spacing for the Bottom Chord and to laterally "stiffen" the group of Trusses. Place Continuous Lateral Restraint and Diagonal Bracing on top of the Bottom Chord (Figures B1-27 and 28). This material can be removed after the permanent ceiling Diaphragm is in place or remain to become part of the Permanent Building Stability Bracing (PBSB) system.



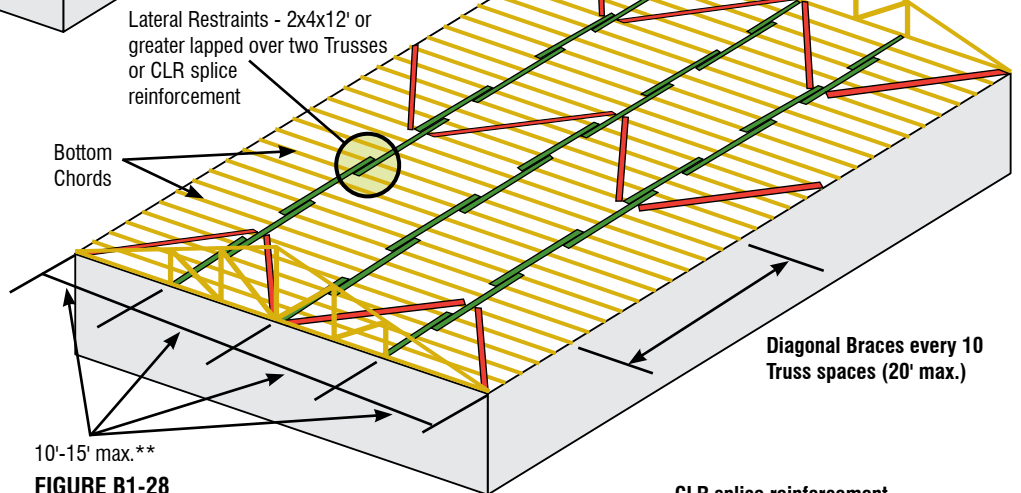
**FIGURE B1-27**



10'-15' max. Same spacing as Bottom Chord Lateral Restraint. See "IMPORTANT NOTE" at the right.

**FIGURE B1-26**

**Note:** Some chord and Web members not shown for clarity.



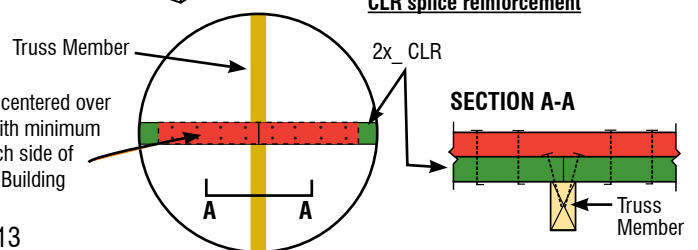
10'-15' max.\*\*

**FIGURE B1-28**

**Webs that require Continuous Lateral Restraint (CLR) must also be Diagonally Braced for rigidity. Install Diagonal Bracing along the same Web Member Planes that require CLR. Refer to the Truss Design Drawings to determine which webs, if any, require CLR. Installing the CLR and Diagonal Bracing as Trusses are installed saves time.**

**Note:** Web members that require more than one row of CLR shall have the CLR and Diagonal Bracing installed as the Trusses are installed.

Minimum 2' 2x Scab block centered over CLR splice. Attach to CLR with minimum 8-16d (0.135x3.5") nails each side of splice or as specified by the Building Designer



**\*\*IMPORTANT NOTE:** Install Bottom Chord **Temporary** Lateral Restraint (BCTLR) in rows no more than 15' on-center (o.c). Install Bottom Chord **Permanent** Lateral Restraint (BCPLR) at the spacings specified in the TDD and Construction Documents. The maximum on-center spacing of permanent Lateral Restraint is 10' but can be less if required by the TDD and/or Building Designer.

- ✓ Connect end of restraint to end wall. **Add Diagonal Bracing at each end and every 10 Truss spaces (20' maximum).**
- ✓ Long spans, heavy loads or Truss spacings greater than 2' o.c. often require closer spacing of Lateral Restraint and Diagonal Bracing. Consult the Building Designer or **BCSI-B10**.

## ALTERNATIVE METHODS OF TEMPORARY INSTALLATION RESTRAINT/BRACING

- ✓ Alternate proprietary methods of Temporary Installation Restraint/Bracing are available. See manufacturer's specifications.

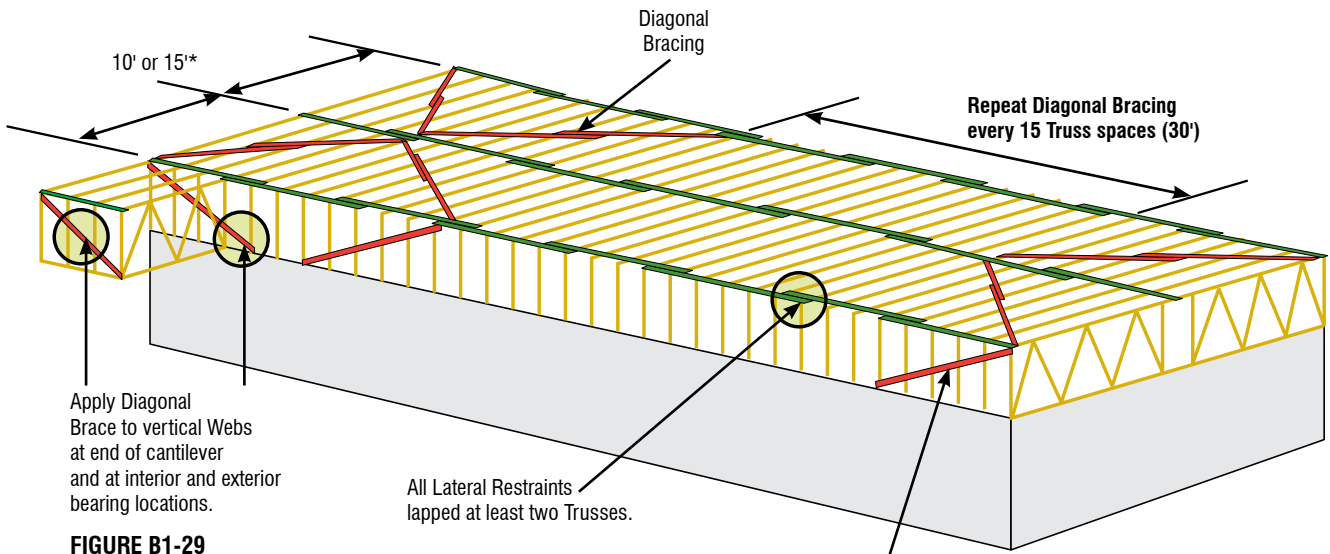


**WARNING: LATERAL RESTRAINT & DIAGONAL BRACING ARE VERY IMPORTANT!**

See **BCSI-B2** for additional information.

## RESTRAINT AND BRACING 3X2 & 4X2 PARALLEL CHORD TRUSSES

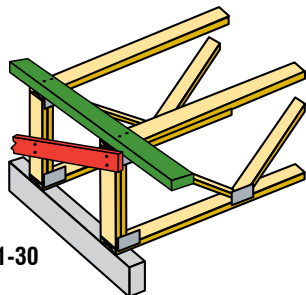
- ✓ 3x2 and 4x2 Parallel Chord Truss Top Chords can be Laterally Restrained and Diagonally Braced as provided in Figure B1-29 through B1-33. See also **BCSI-B7** for additional information.
- ✓ **NOTE:** End diagonals, with TCTLR or Ribbon (band) board, blocking panels, or rim board as specified by the Building Designer, are essential for stability and must be installed on both ends of the Truss System and repeated every 15 Truss spaces (30' maximum). See Figures B1-30, 31, 32 and 33.



**FIGURE B1-29**

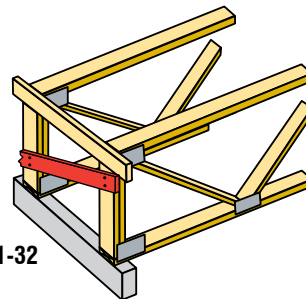
See NOTE above and Figures B1-30, 31, 32 and 33.

\*Top Chord Temporary Lateral Restraint spacing shall be 10' o.c. max. for 3x2 chords and 15' o.c. for 4x2 chords.



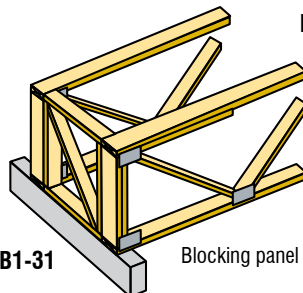
**FIGURE B1-30**

Top Chord Temporary Lateral Restraint with Diagonal Brace



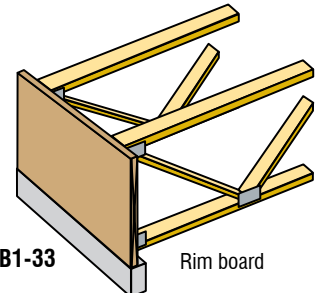
**FIGURE B1-32**

Ribbon board with Diagonal Brace



**FIGURE B1-31**

Blocking panel



**FIGURE B1-33**

Rim board

## CONSTRUCTION LOADING

- ✓ Construction materials shall be distributed properly. See also **BCSI-B4** for additional information.
- ⊘ **DO NOT** proceed with construction until all Lateral Restraint and Bracing is securely and properly in place.
- ⊘ **DON'T** stack materials on unbraced Trusses.

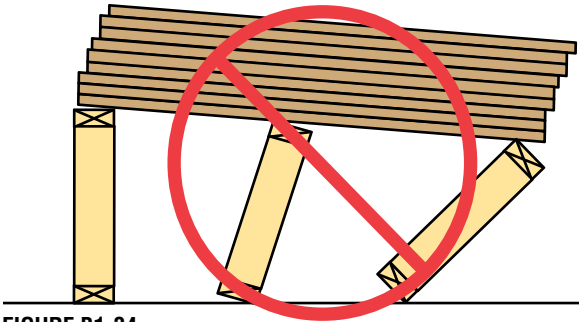


FIGURE B1-34

- ⊘ **NEVER** stack materials near a peak or at the center of a span.

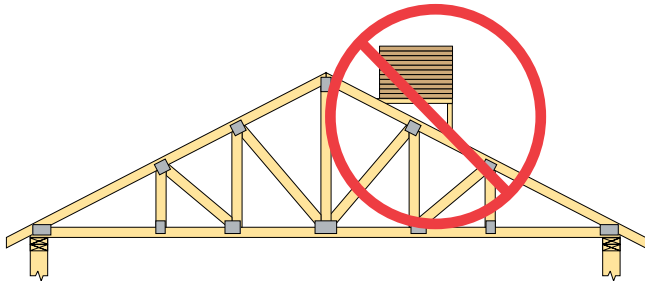


FIGURE B1-35

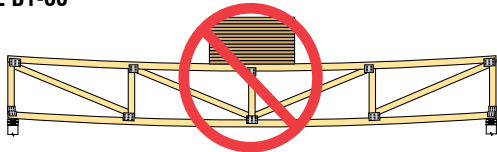


FIGURE B1-36

- ⊘ **NEVER** stack materials on the cantilever of a Truss.

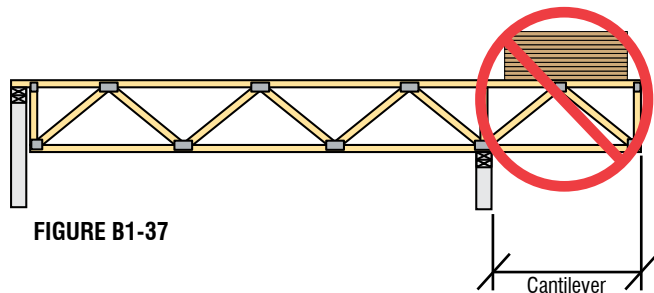


FIGURE B1-37

- ⊘ **DON'T** drop loads of any material on Trusses. Truss damage from the impact is possible even if the weight of the material is small.

- ✓ Always stack materials over two or more Trusses.
- ⊘ **NEVER** overload small groups or single Trusses. Position load over as many Trusses as possible. Do not exceed stack depths in Table B1-5, unless alternative information is provided by the Building Designer or Truss Manufacturer.

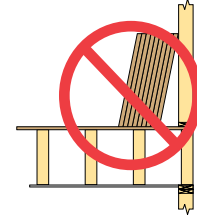


FIGURE B1-38

- ✓ Place material next to outside Load bearing wall or directly over interior Load bearing wall.
- ✓ Position stacks of materials flat with the longest dimension perpendicular to the Trusses as shown in Figure B1-39.

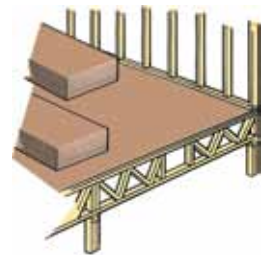


FIGURE B1-39

Maximum Stack Height for Material on Trusses <sup>1, 2</sup>	
Material	Height
Gypsum Board	12"
Plywood or OSB	16"
Asphalt Shingles	2 bundles
Concrete Block	8"
Clay Tile	3-4 tiles high

TABLE B1-5

1. This table is based on Trusses designed with a Live load of 40 psf or greater. For other loading conditions, contact a Registered Design Professional.
2. Stack heights assume short-term duration of Load. Install stacks of materials as quickly as possible.

**Note:** Heavy roofing tile, such as clay or stone slate, is often “dry-stacked” on the roof for a period of time to allow the roof/ceiling assembly time to “settle” before the finished ceiling is installed. Limit stack heights to those provided in Table B1-5 and stacking periods to approximately one week, unless alternative information is provided by the Building Designer, Truss Designer or Truss Manufacturer.

- ⊘ **NEVER** cut, alter or drill any structural member of a Truss unless specifically permitted by the Truss Design Drawing.

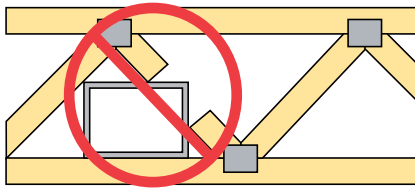


FIGURE B1-40

- ✓ Any field modification that involves the cutting, drilling, or relocation of any structural Truss member or Truss Plate shall not be done without the approval of the Truss Manufacturer or a Registered Design Professional.
- ✓ Trimming Top Chord overhangs to length is considered a part of normal erection and is permitted.

### ADDITIONAL NOTES

- NOTICE** Errors in Building lines and/or dimensions, or errors by others (i.e., uneven bearing elevations, walls not parallel, etc.), shall be corrected by the Contractor BEFORE erection/installation of Trusses begins.
- NOTICE** Non-Load bearing walls can transfer loads, if large construction Loads are applied above them. This can cause deflection problems in the floors below.
- NOTICE** Under industry guidelines, Trusses that have been field altered at the jobsite or overloaded during the construction phase will render your Truss Manufacturer's limited warranty null and void. Check your Truss Manufacturer's limited warranty for specific information.

### GENERAL NOTES

- ✓ For additional guidance concerning Bracing design, refer to DSB-89, *Recommended Design Specification for Temporary Bracing of Metal Plate Connected Wood Trusses*.

**DISCLAIMER:** The Truss Manufacturer and Truss Designer rely on the presumption that the Contractor and crane operator are professionals and that he/she has the capability to undertake the work they have agreed to do on any given project. If the Contractor believes he/she needs assistance in some aspect of the construction project, he/she should seek assistance from a competent party. The methods and procedures outlined in this document are intended to ensure that the overall construction techniques employed will put the Trusses into place SAFELY. These recommendations for handling, installing, restraining and Bracing Trusses are based upon the collective experience of leading personnel involved with Truss design, manufacture and installation, but must, due to the nature of responsibilities involved, be presented only as a GUIDE for use by a qualified Building Designer or Contractor. It is not intended that these recommendations be interpreted as superior to the Building Designer's design specification for handling, installing, restraining and Bracing Trusses and it does not preclude the use of other equivalent methods for restraining/Bracing and providing stability for the walls, columns, floors, roofs and all the interrelated Structural Building Components as determined by the Contractor. Thus, SBCA, TPI and those who participated in the development of this guide expressly disclaim any responsibility for damages arising from the use, application, or reliance on the recommendations and information contained herein.

## TRUSS INSTALLATION & TEMPORARY RESTRAINT/BRACING

### COMMENTARY AND RECOMMENDATIONS

For Trusses spaced up to 2'-0" on-center and up to 80'-0" in length.

**⚠ WARNING** The erection of Trusses is inherently dangerous and requires, above all, careful planning and communication between the Contractor, crane operator and installation crew. Depending on the experience of the Contractor, it is strongly recommended that a meeting be held with all onsite individuals involved in the lifting/hoisting, installing and restraint/Bracing operations to review the provisions of:

- the Construction Documents (i.e., architectural/structural plans and specifications)
- the Truss Submittal Package, which includes:
  - the Truss Design Drawings (TDD)
  - the Truss Placement Diagram(s) (if/when required by the Contract)
- this BCSI book and/or B-Series Summary Sheets (when provided)
- the erection and installation plan (if provided)
- site-specific conditions and issues
- OSHA jobsite lifting and fall protection requirements (see [BCSI-B11](#))

**⚠ DANGER!** Disregarding handling, installing, restraining and Bracing safety recommendations is the major cause of Truss erection/installation accidents. Ignoring an unsafe condition or action will greatly increase the probability of an accident resulting in property damage, serious personal injury and/or death.

Proper Truss erection, installation, restraint and Bracing requires an understanding of Triangulation within and between the various planes of the Truss (i.e., Top Chord, Bottom Chord and Web). **It is critical to note that all Lateral Restraints must be braced.** Lateral Restraint by itself is not adequate to resist the buckling forces in the members to which it is attached without the rigidity provided by Bracing. Bracing is typically provided by adding Diagonal Bracing within the same plane of the Lateral Restraint or by anchoring the Lateral Restraint to a lateral force resisting member such as a shear wall. This understanding is essential for a safe installation.

The Contractor shall be familiar with general Bracing concepts as discussed in the documents referenced above. It is not intended that these recommendations be interpreted as superior to the Building Designer's design specification for handling, installing, restraining and Bracing Trusses, and it does not preclude the use of other equivalent methods for restraining/Bracing and providing stability for the walls, columns, floors, roof and all the interrelated Structural Building Components as may be determined by the Contractor. The Contractor is also responsible for the proper and safe lifting of the Trusses. See [BCSI-B1](#) for additional commentary

on handling and installing Trusses. Every project has different site conditions that can have a specific affect on the erection process. Before the first Truss is erected, every individual on the erection crew, including the crane operator, needs to understand the installation plan and the intended Lateral Restraint and Diagonal Bracing requirements for a safe, efficient and accident-free jobsite.

**⊘ WHAT NOT TO DO:** Fail to install Diagonal Bracing.



PHOTO B2-1

**✓ Always Diagonally Brace for Safety!**



PHOTO B2-2

### CONSIDERATIONS BEFORE STARTING

Prior to starting the erection/installation process, there are several checks that are the responsibility of the Contractor. These include:

- ✓ 1. Is there a complete set of Building Designer-approved Construction Documents on the jobsite?
- ✓ 2. Is the Building the correct size? Are all as-built dimensions the same as those depicted in the Construction Documents? If not, corrective actions shall be taken prior to Truss installation.
- ✓ 3. Are all the Load bearing supports (e.g., walls, columns, headers, beams, etc.) plumb and properly braced? Stopping in the middle of the Truss installation to straighten and brace these supports is dangerous.
- ⚠ **DANGER!** Having an inadequately braced support system buckle during the erection process will cause property damage, personal injury and/or death.
- ✓ 4. Are all bearing supports accurately and securely installed at the locations shown on the Construction Documents? If not, corrective actions shall be taken prior to Truss installation.
- ✓ 5. Are the tops of all bearing supports at the correct elevation? Uneven bearing surfaces are a major cause of Truss unevenness, and can cause costly delays and/or repairs. Check and correct bearing wall deficiencies prior to starting the Truss erection process.
- ✓ 6. Are the bearing supports straight along their length, and parallel where they should be parallel? If not, corrective action shall be taken prior to Truss installation.
- ✓ 7. Are the delivered Trusses the right size? Check Trusses for dimensions and damage as soon as they arrive on the site to avoid possible installation delays.
- ✓ 8. Are all required hangers, angle clips, tie-downs, and restraint/Bracing materials onsite and located where they will be readily accessible when needed? Obtain all materials or parts prior to starting the Truss erection process. Do not attempt to “make do” without all required materials. Jobsite safety has no room for shortcuts.
- ✓ 9. Is the jobsite clean and neat with scraps and trash from the construction process removed or in designated areas away from the work area? Truss erection typically involves bringing the Trusses in overhead with the assistance of a crane. Worker attention is often directed upward even while moving around. A clean jobsite will help to avoid trips and falls.
- ✓ 10. Have the appropriate Ground Bracing techniques for the first Truss been determined? Steeply sloping site terrain or upper-level Truss installations usually warrant using an Interior Ground Brace scheme, as Exterior Ground Brace Diagonals get exceedingly long and require substantial Bracing themselves.

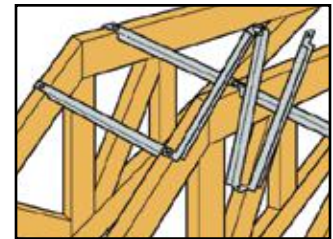
- ✓ 11. Is the Building configuration such that the first set of Trusses can be stabilized by tying them off to the Building structure (existing or new) itself? Particular attention shall be paid to the adequacy of the wall Bracing if this technique is chosen.
- ✓ 12. Is the roof a hip style? For hip style roofs, use the crane to lift and hold the Girder Truss while the end jacks are installed to brace the Girder Truss. This eliminates the need for Ground Bracing the first Truss, assuming all hardware and hangers are properly installed prior to the crane releasing the Girder Truss. Properly attaching the Girder Trusses and jack Trusses at their bearing points and permanently restraining and Diagonally Bracing this assembly will provide a rigid framework to which subsequent Trusses can be restrained and braced.

⚠ **DANGER! Truss spacers are for spacing only! Never use the commercially available non-structural metal fold-out single unit spacer products for Truss LATERAL RESTRAINT.** Truss spacers are not intended as structural members and are insufficient as Lateral Restraint and Bracing of any kind. Approved Proprietary Metal Restraint/Bracing Products are acceptable. Property damage, personal injury and/or death are possible if this warning is not heeded.



Truss spacers are insufficient as Lateral Restraint and Bracing.

PHOTO B2-3



Example of a non-structural metal fold-out spacer.

FIGURE B2-1

### GENERAL SAFETY REMINDERS

Before starting, here are some general safety reminders:

- 1. Brief all members of the erection/installation crew as to the installation plan and the intended Lateral Restraint and Diagonal Bracing requirements.
- 2. If possible, fasten together all multi-ply Trusses, including Girder Trusses, per the TDD prior to lifting into their assumed positions on the Building (see **BCSI-B9**).
- 3. **Check all Trusses for damage (see BCSI-B5) prior to, during and after the erection/installation process. Do not install damaged Trusses unless specifically instructed on how to do so by the Building Designer, Truss Designer or Truss Manufacturer.**

**NOTICE** Brace all rows of Lateral Restraint with Diagonal Bracing. Lateral Restraint alone is not adequate without the added rigidity of Triangulation provided by the Diagonal Bracing.

⚠ **WARNING** Property damage, bodily injury and/or death are possible when Trusses are improperly handled, installed, restrained and/or braced. Installation of Trusses can be dangerous, particularly Long Span Trusses in excess of 60'.



## SUMMARY OF THE EIGHT STEPS IN THE TRUSS INSTALLATION PROCESS

- ✓ **STEP 1.** Establish Ground Bracing procedure, interior or exterior.

If ground level is too far from Truss for Exterior Ground Bracing, use Interior Ground Bracing

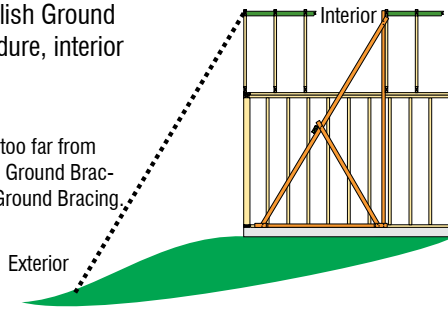


FIGURE B2-2

- ✓ **STEP 2.** Determine the on-center spacing of Top Chord Temporary Lateral Restraint (TCLR) (see Table B2-1, page 20).
- ✓ **STEP 3.** Set first Truss (or Gable End Frame) and fasten securely to Ground Bracing verticals using minimum 2-16d (0.135x3.5") nails clinched at each junction, and to the wall, or as directed by the Building Designer. Install Truss straight, plane and plumb, as each subsequent Truss will have a tendency to follow the shape of this first Truss.

### NOTICE

The use of Ground Brace Verticals alone, attached to the end wall, is not considered good construction practice and is not permitted.

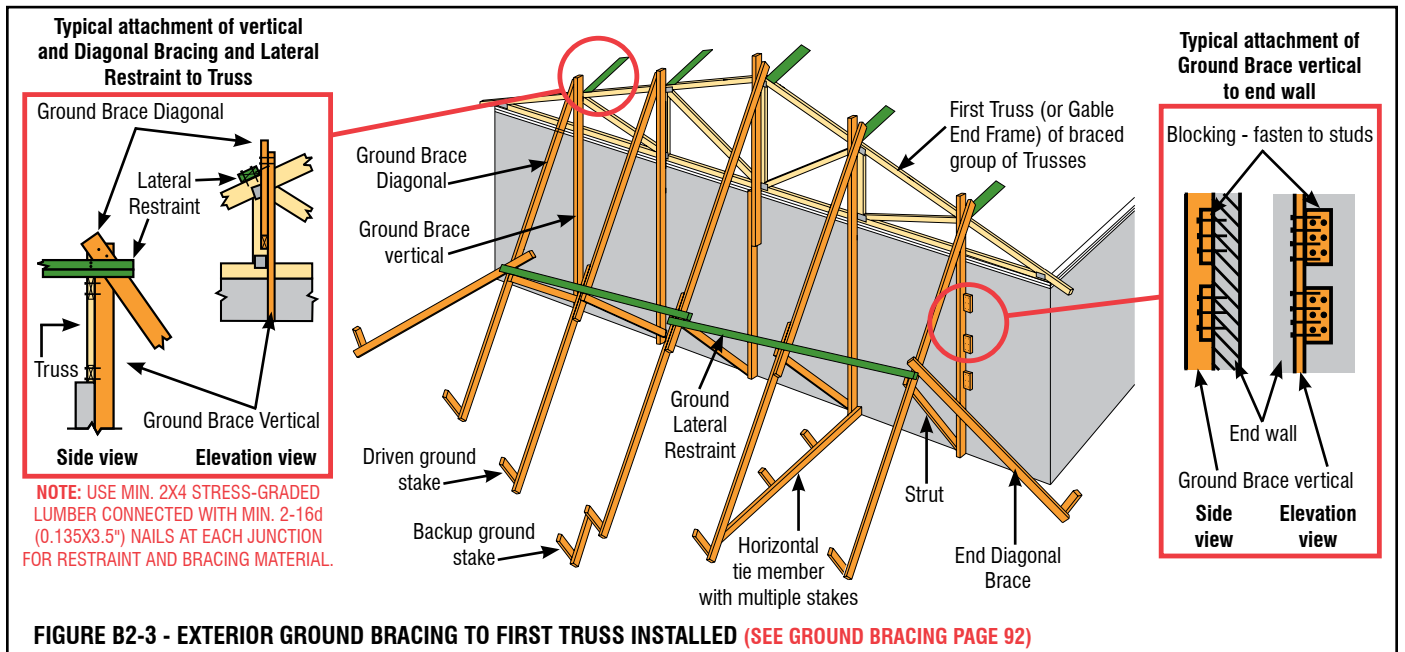


FIGURE B2-3 - EXTERIOR GROUND BRACING TO FIRST TRUSS INSTALLED (SEE GROUND BRACING PAGE 92)

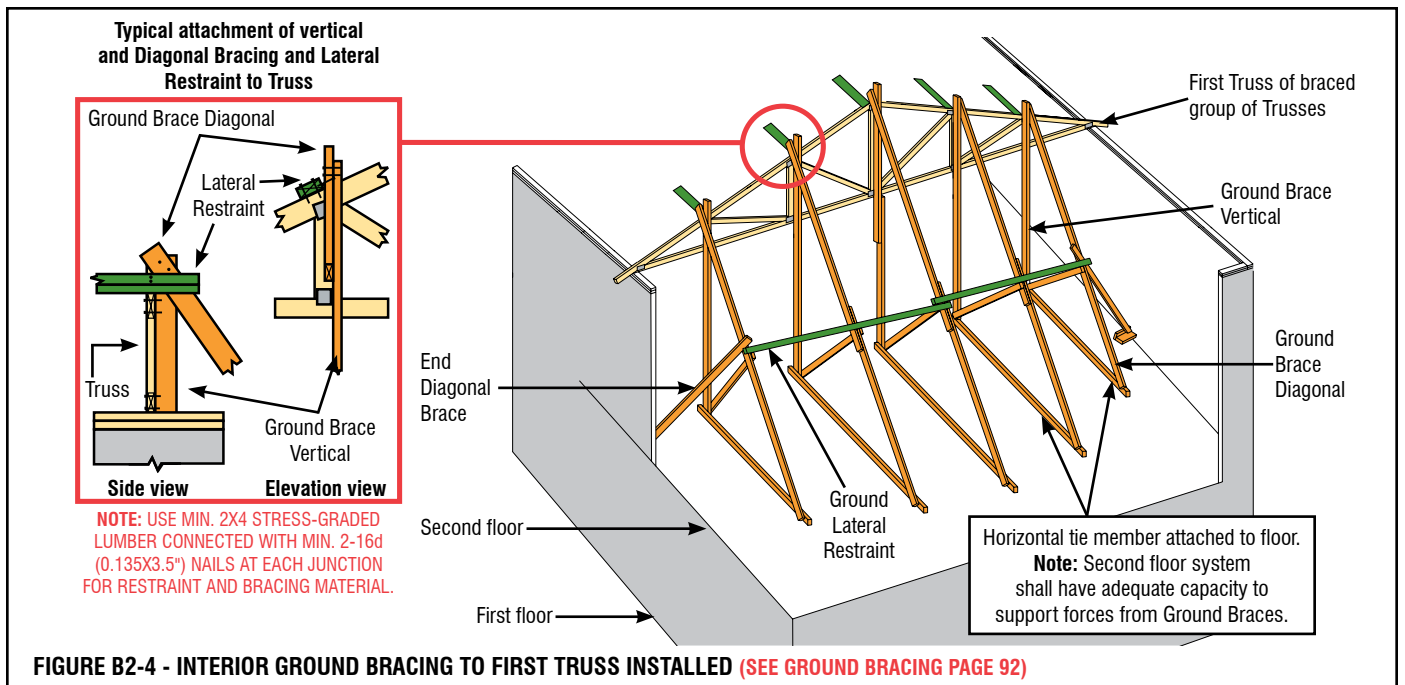


FIGURE B2-4 - INTERIOR GROUND BRACING TO FIRST TRUSS INSTALLED (SEE GROUND BRACING PAGE 92)

## BCSI-B2: Truss Installation & Temporary Restraint/Bracing

✔ **STEP 4.** Set Trusses 2, 3, 4 and 5 with TCTLR in line with Ground Bracing. Attach securely at all bearings, shimming bearings as necessary. Allow a Floating Connection for the attachment to all non-bearing interior walls. Do not shim.

⚠ **DANGER! NEVER release the Truss being installed from the lifting slings/crane until Truss is in the intended position, all TCTLR are installed and bearing attachments are made.** Exercise caution to assure the Trusses are accurately located at their proper on-center spacing, while the Lateral Restraint is being applied. Releasing a Truss early or releasing a Truss to adjust spacing is an extremely dangerous practice. Doing so leaves the Truss in an unstable condition and places the installation crew in danger. This is an UNSAFE act that can cause the Truss to topple and cause serious personal injury or death.

✔ **STEP 5.** Install Top Chord Plane Diagonal Bracing (see Diagonal Bracing options based upon TCTLR design on page 24). Alternately, **Structural Sheathing correctly applied at this stage will act as Diagonal Bracing** for the Top Chords and adequately brace the first five Trusses (see Figure B2-5).

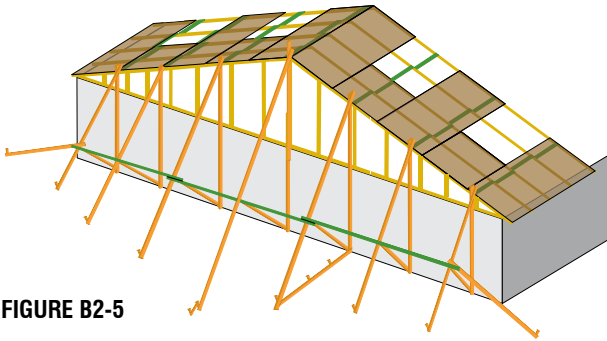


FIGURE B2-5

✔ **STEP 6.** Install Web Member Plane Diagonal Bracing to stabilize the first five Trusses set (Figure B2-34, page 26). Web member Lateral Restraint (if indicated on the TDD), together with Diagonal Bracing or some other form of Permanent Building Stability Bracing (PBSB), serves this purpose.

✔ **STEP 7.** Install the Bottom Chord Plane Temporary Lateral Restraint and Diagonal Bracing to stabilize the Bottom Chord plane(s).

⊘ **DO NOT** remove Ground Bracing until all the Top Chord, Web and Bottom Chord Lateral Restraint and Diagonal Bracing is installed for at least the first five Trusses.

**NOTICE** Start Structural Sheathing immediately after securing the Bracing onto the Web and Bottom Chord Planes.

✔ **STEP 8.** Continue the erection/installation process by installing the next four Trusses with the TCTLR and then repeating Steps 5, 6 and 7. Repeat the process with sets of four Trusses until all of the remaining Trusses in the Building run have been installed.

### DETAILS OF THE EIGHT-STEP TRUSS INSTALLATION PROCESS

#### STEP 1. ESTABLISHING GROUND BRACING AND SETTING THE FIRST TRUSS

Ground Bracing can be installed on either the exterior or interior of the Building, to the top of an adjacent wall, or to the structure itself. Site conditions dictate the most efficient procedure. The procedure selected is not as important as following the simple guidelines for locating the Ground Braces. Ground Brace locations are determined by the requirements for TCTLR. Locations for TCTLR are determined by the overall Truss length (see Table B2-1) and the length of the Top Chord between pitch breaks (i.e., change of slope). It is important to note that TCTLR is required at EVERY pitch break (see Figure B2-10, page 21). The portion of the Top Chord between pitch breaks shall be restrained at intervals not exceeding the lengths given in Table B2-1 (see Figures B2-6, 7 and 10, pages 20-21).

Set first Truss into position and connect it to each bearing and then to the Ground Brace verticals where they intersect the Top and Bottom Chords of the Truss.

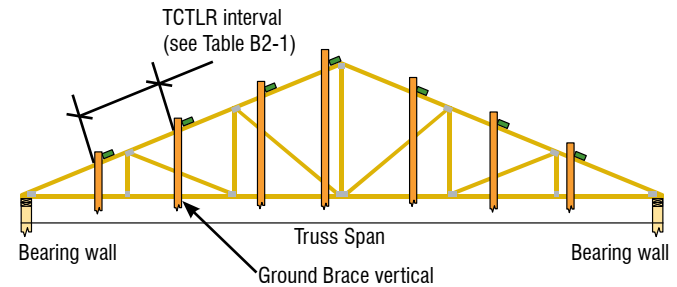


FIGURE B2-6

#### STEP 2. DETERMINE GROUND BRACE LOCATION

Maximum Top Chord Temporary Lateral Restraint (TCTLR) Spacing**	
Truss Span	TCTLR Spacing
Up to 30'	10' on-center maximum
30' - 45'	8' on-center maximum
45' - 60'	6' on-center maximum
60' - 80' *	4' on-center maximum

\*Consult a Registered Design Professional for Trusses longer than 60'.

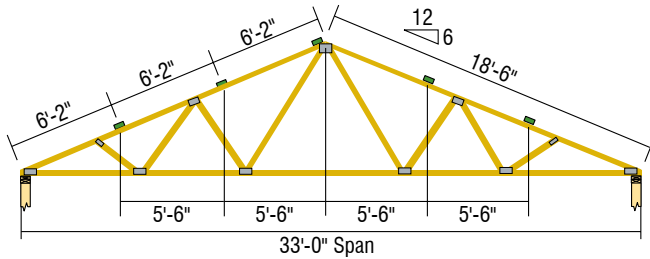
\*\*For Trusses spaced greater than 2' o.c., see also BCSI-B10.

TABLE B2-1

## BCSI-B2: Truss Installation & Temporary Restraint/Bracing

- ✔ The TCTLR and Diagonal Bracing approach provided below applies to all sloping chord Trusses, Scissors Trusses, 2x Parallel Chord Trusses and Piggyback Trusses. **Note:** 2x Trusses with depths less than 1/15th of the span at all locations away from bearings require more complex temporary Bracing. Consult a Registered Design Professional.

✔ **Example 1: 33' span 6/12 Truss**

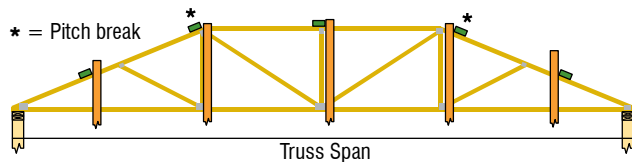


**FIGURE B2-7**

The 33' Truss above will require TCTLR at not more than 8' on-center (o.c.) per Table B2-1, page 20. The length of the Top Chord from the peak to Truss heel (as measured along the slope) is roughly 18'-6". Adding one row of TCTLR at the midpoint of the 18'-6" segment leaves two 9'-3" sections, which exceeds the 8' on-center maximum in Table B2-1. Therefore, the chord segment needs to be divided into three sections  $18'-6" \div 3 = 6'-2"$ . TCTLR will be 6'-2" on-center along the slope.

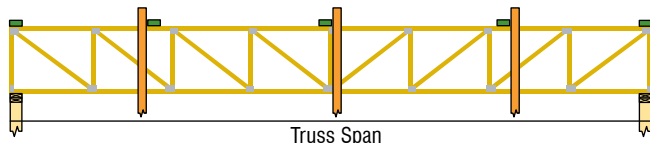
✔ **Example 2: Locating TCTLR and Ground Bracing for hip Trusses and special configuration Trusses.**

Locate a TCTLR at each pitch break along the Top Chord. Additional rows of TCTLR are required according to the maximum on-center spacing in Table B2-1, page 20.



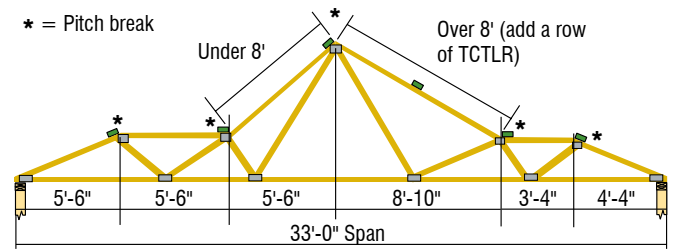
Hip Truss with Top Chord Temporary Lateral Restraint and Ground Brace verticals.

**FIGURE B2-8**



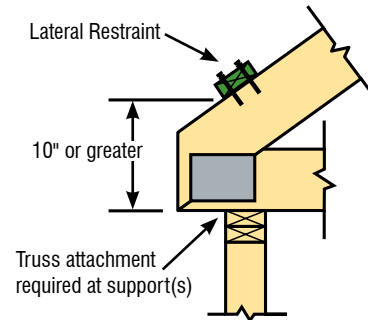
Parallel Chord roof Truss with Top Chord Temporary Lateral Restraint and Ground Brace verticals.

**FIGURE B2-9**



**FIGURE B2-10**

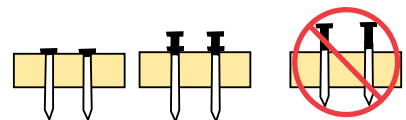
- ✔ Continuous TCTLR is required over bearing if the height is 10" or greater as shown.



**FIGURE B2-11**

- ✔ For all bracing and Lateral Restraint members, nail as follows (except end-grain-nailed short member Lateral Restraints, which require 16d deformed shank (i.e., ring- or screw-shank) nails):

- Use at least 2-10d (0.128x3"), 2-12d (0.128x3.25") or 2-16d (0.131x3.5") nails into each Truss for both Lateral Restraint and Diagonal Bracing members.



**FIGURE B2-12**

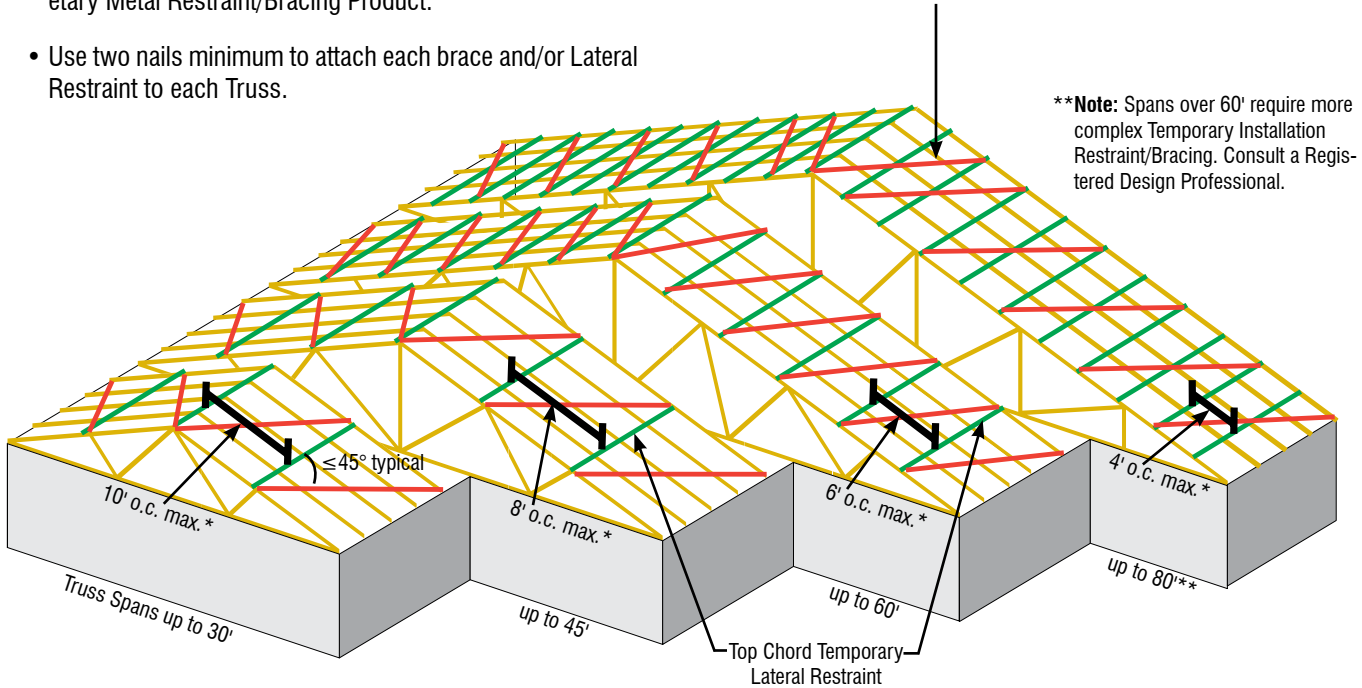
- Minimum size Bracing and Lateral Restraint material is 2x4 stress-graded lumber, or approved Proprietary Metal Restraint/Bracing, unless otherwise specified by the Building Designer.
- Drive nails flush (or use double-headed [duplex] nails for ease of removal).

## BCSI-B2: Truss Installation & Temporary Restraint/Bracing

✓ Figure B2-13 depicts the maximum on-center spacing of TCTLR per Table B2-1, page 20. Ground Bracing not shown for clarity.

- All Lateral Restraint and Diagonal Bracing material is at least 2x4 stress-graded lumber, or use an approved Proprietary Metal Restraint/Bracing Product.
- Use two nails minimum to attach each brace and/or Lateral Restraint to each Truss.

**Apply Diagonal Bracing or Structural Sheathing immediately. For spans over 60', applying Structural Sheathing immediately is the preferred method (see Step 5, page 25).**



**\*NOTE:** Maximum spacing for Top Chord Temporary Lateral Restraint

FIGURE B2-13

**NOTICE** These TCTLR options apply to all sloped and Parallel Chord Trusses built with the wide face of the lumber oriented vertically.

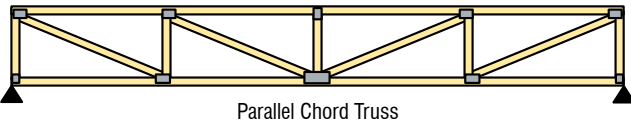


FIGURE B2-14

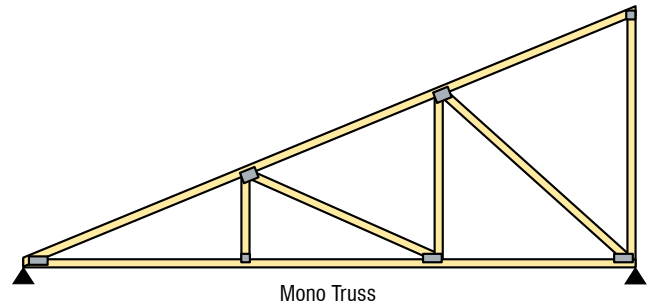


FIGURE B2-16

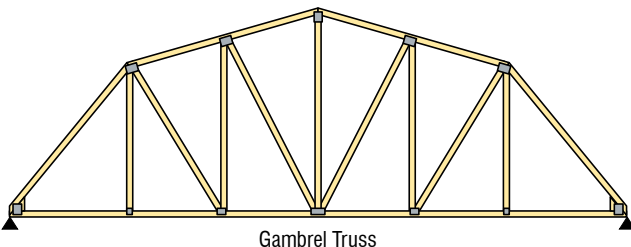


FIGURE B2-15

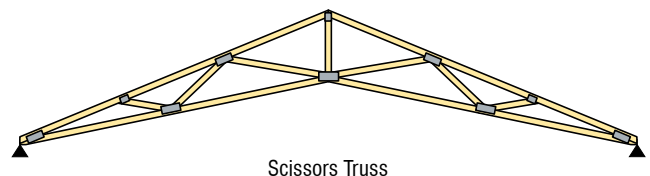


FIGURE B2-17

## BCSI-B2: Truss Installation & Temporary Restraint/Bracing

### STEP 3. SET FIRST TRUSS AND FASTEN SECURELY TO GROUND BRACES

- ✓ Construct and install the Ground Bracing for the first Truss from the Building interior or exterior.
- ✓ Example of first Truss installed with Interior Ground Bracing:

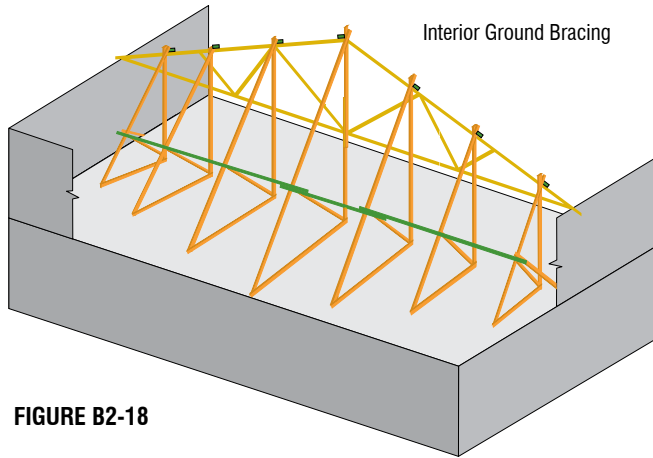


FIGURE B2-18

- ⚠ **CAUTION** First Truss must be attached securely at all bearing locations and to all required Ground Braces prior to removing the hoisting supports.

- ✓ Example of first Truss installed with Exterior Ground Bracing:

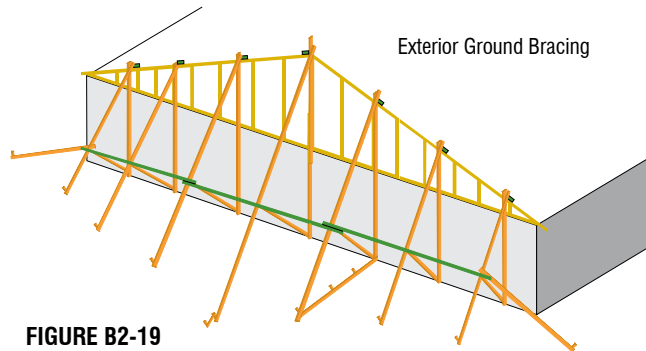


FIGURE B2-19

- ✓ Example of first Truss installed with interior Ground Bracing to top of wall and back to floor below (see Figures B2-20 and 21).

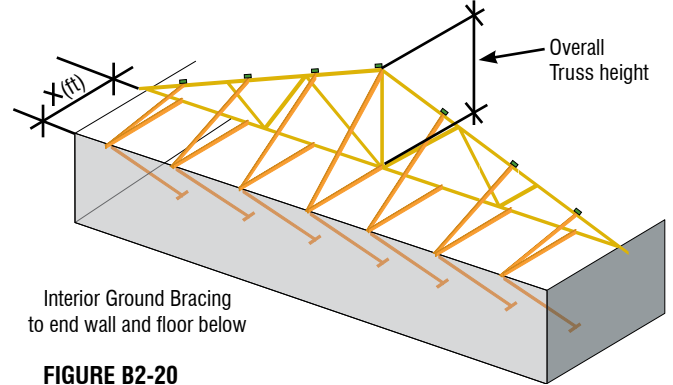


FIGURE B2-20

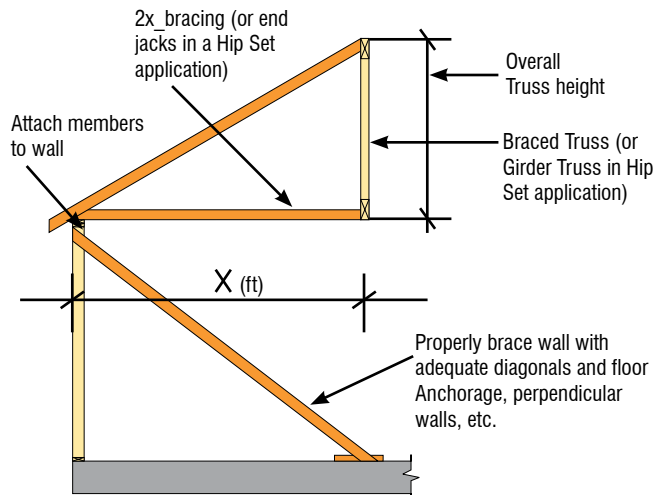


FIGURE B2-21

- ✓  $X = \text{wall setback (ft)} = \text{overall Truss height (ft-in)}$  rounded to next full Truss Spacing (ft), or Girder Truss set back in hip end framing. For example, if the overall Truss height is 5'-6" and the Trusses are to be spaced at 2' on-center (o.c.), use a wall setback, X, of 6' (i.e., three Truss Spaces @ 2' = 6' > 5'-6").

# BCSI-B2: Truss Installation & Temporary Restraint/Bracing

## STEP 4. SET TRUSSES 2, 3, 4 AND 5 WITH TCTLR IN LINE WITH GROUND BRACING

- ✔ Set Trusses 2, 3, 4 and 5 using the Short Member Temporary Lateral Restraint (on top of or between Trusses) in line with the Ground Braces.
- ✔ Example of first five Trusses with Interior Ground Bracing:

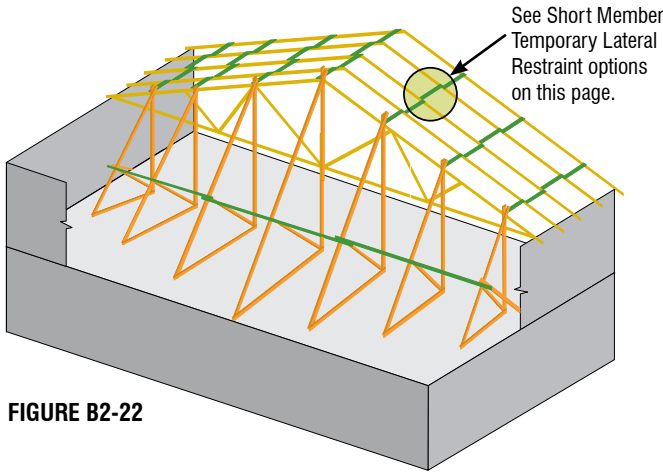


FIGURE B2-22

- ✔ Example of first five Trusses with Exterior Ground Bracing:

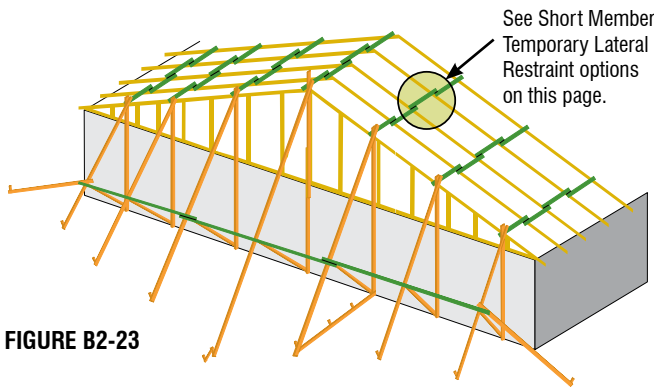


FIGURE B2-23

- ✔ Example of first five Trusses with Interior Ground Bracing to top of wall and back to floor below:

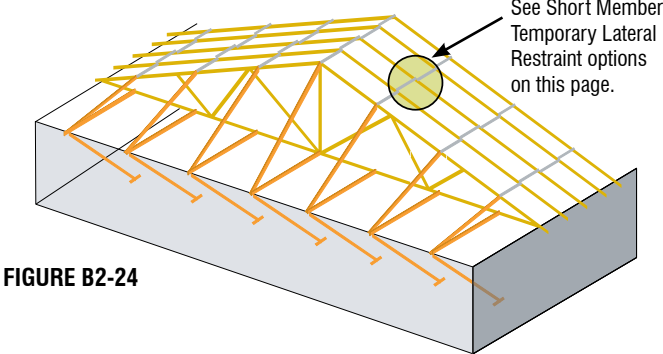
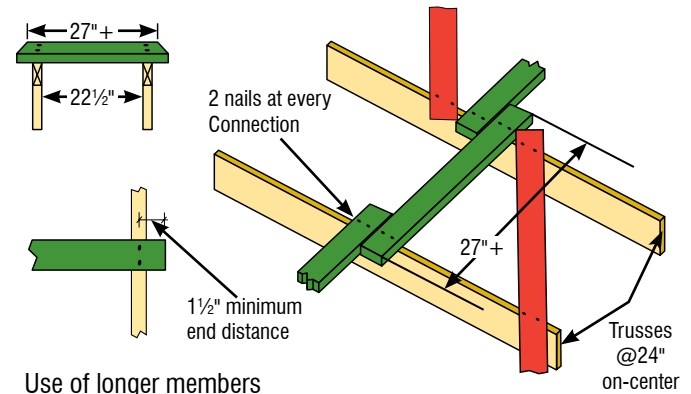


FIGURE B2-24

**NOTICE** The following three Short Member Temporary Lateral Restraint Options require that the **Diagonal Bracing be installed continuously**. Install Diagonal Bracing to the Top Chord plane immediately after the initial five Trusses have been set and restrained. Thereafter, install Diagonal Bracing to each subsequent set of four Trusses.

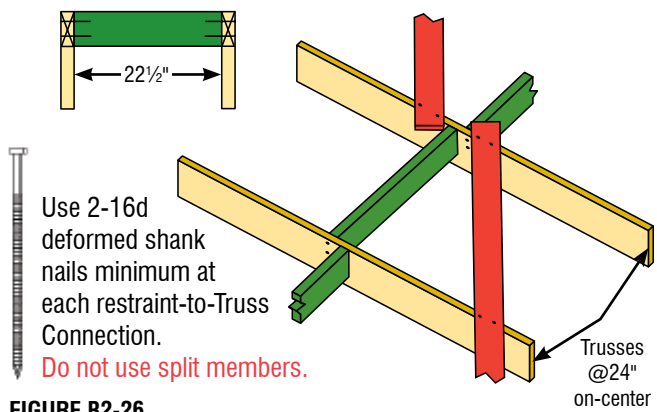
## OPTION 1: DETAIL – Short Member Temporary Lateral Restraint Installed on Top of Trusses



Use of longer members will reduce splitting potential.  
**Do not use split members.**

FIGURE B2-25

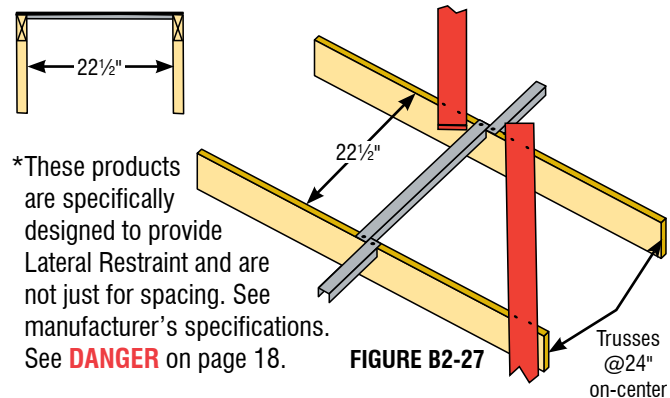
## OPTION 2: DETAIL – Short Member Temporary Lateral Restraint Installed Between Trusses



**Do not use split members.**

FIGURE B2-26

## OPTION 3: PROPRIETARY METAL RESTRAINT/BRACING PRODUCTS\*



\*These products are specifically designed to provide Lateral Restraint and are not just for spacing. See manufacturer's specifications. See **DANGER** on page 18.

FIGURE B2-27

# BCSI-B2: Truss Installation & Temporary Restraint/Bracing

## STEP 5. INSTALL TOP CHORD DIAGONAL BRACING

- ✓ Triangles make Trusses strong. Triangles make Bracing strong.

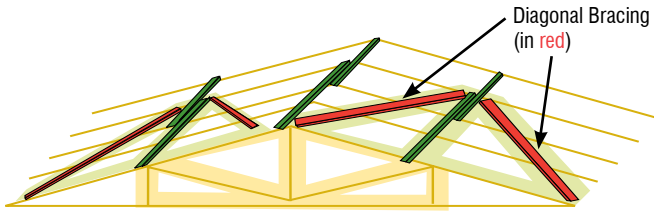


FIGURE B2-28

- ✓ Some Truss Manufacturers attach supplemental warning tags to the Trusses reminding the installer of proper bracing practices. An example of one such tag is shown below.

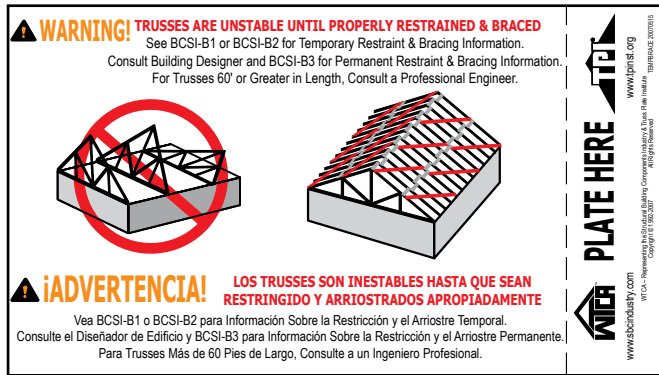


FIGURE B2-29



PHOTO B2-4



PHOTO B2-5

- ✓ Example of Diagonal Bracing on first five Trusses with Interior Ground Bracing:

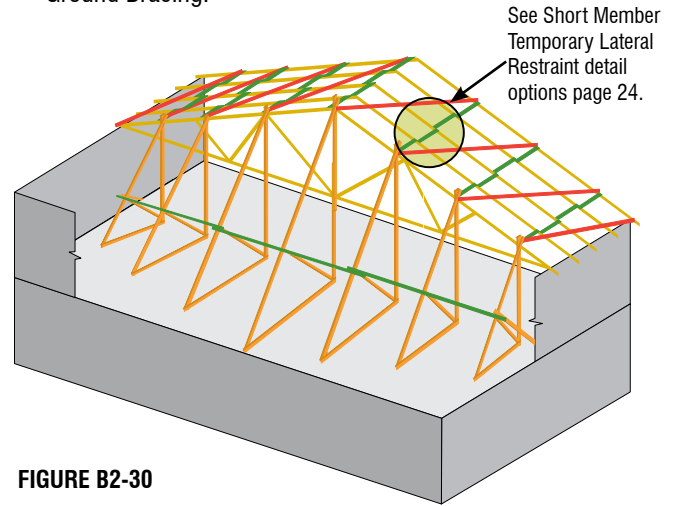


FIGURE B2-30

- ✓ Example of Diagonal Bracing on first five Trusses with Exterior Ground Bracing:

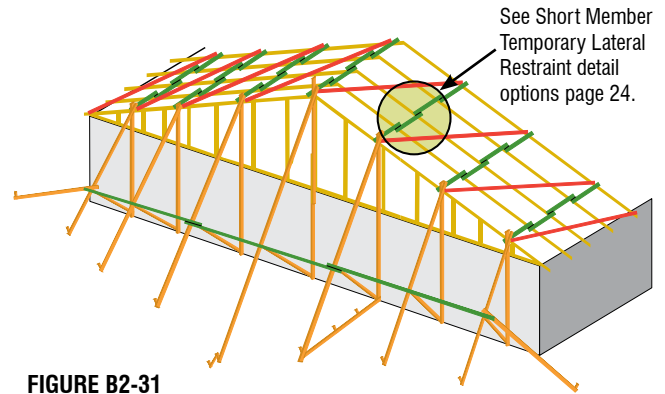


FIGURE B2-31

- ✓ Example of Diagonal Bracing on first five Trusses with Ground Bracing to top of Building wall and back to floor below:

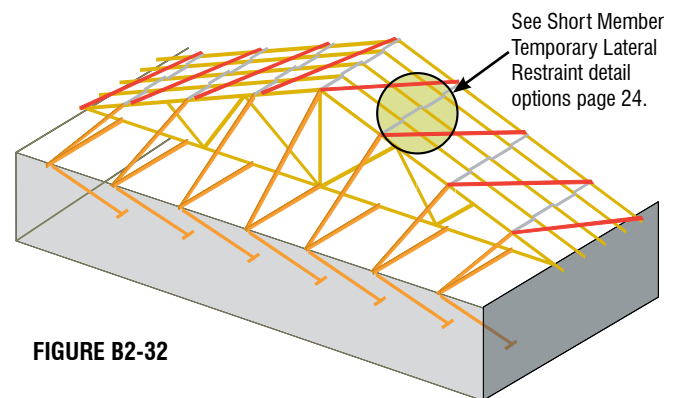
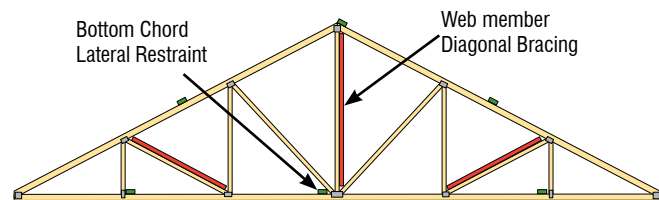


FIGURE B2-32

### STEP 6. INSTALL DIAGONAL BRACING IN WEB MEMBER PLANE

Diagonal Bracing or some other type of Permanent Building Stability Bracing (PBSB) installed perpendicular to the plane of the Trusses and attached to similar web members of adjacent Trusses greatly increases the stability of the Truss System both during and after installation.

- ✓ The Web Diagonal Braces, acting together with the Top Chord and Bottom Chord Temporary Lateral Restraint, form Triangulation perpendicular to the plane of the Trusses, thus creating additional lateral stability for the Trusses.
- ✓ Diagonal Bracing installed for the purpose of increasing the stability of the Truss System during installation shall be installed on web members (verticals whenever possible), located at or near each row of Bottom Chord Lateral Restraint. Properly attached PBSB, such as Structural Sheathing, may be substituted for Diagonal Bracing.
- ✓ Install Web Diagonal Braces so that they cross the web members at approximately 45° and are nailed with a minimum of two nails (see page 21 for minimum sizes) at each end and at each intersecting Truss web.
- ✓ Use minimum 2x4 stress-graded lumber for Web Diagonal Braces, unless another type or size is specified by the Building Designer.
- ✓ The requirements for web member Permanent Individual Truss Member Restraint (PITMR) are specified on the TDD (see [BCSI-B3](#)).
- ✓ Web member PITMR and Diagonal Braces used for installation stability purposes and installed at the locations specified for PBSB can become part of the PBSB system.



Apply Diagonal Bracing to Webs that are near each row of the Bottom Chord Lateral Restraint. See Figure B2-35 for spacing of Bottom Chord Lateral Restraint.

FIGURE B2-33

- ✓ This Bracing approach applies to all Truss types except 3x2 and 4x2 Parallel Chord Trusses.

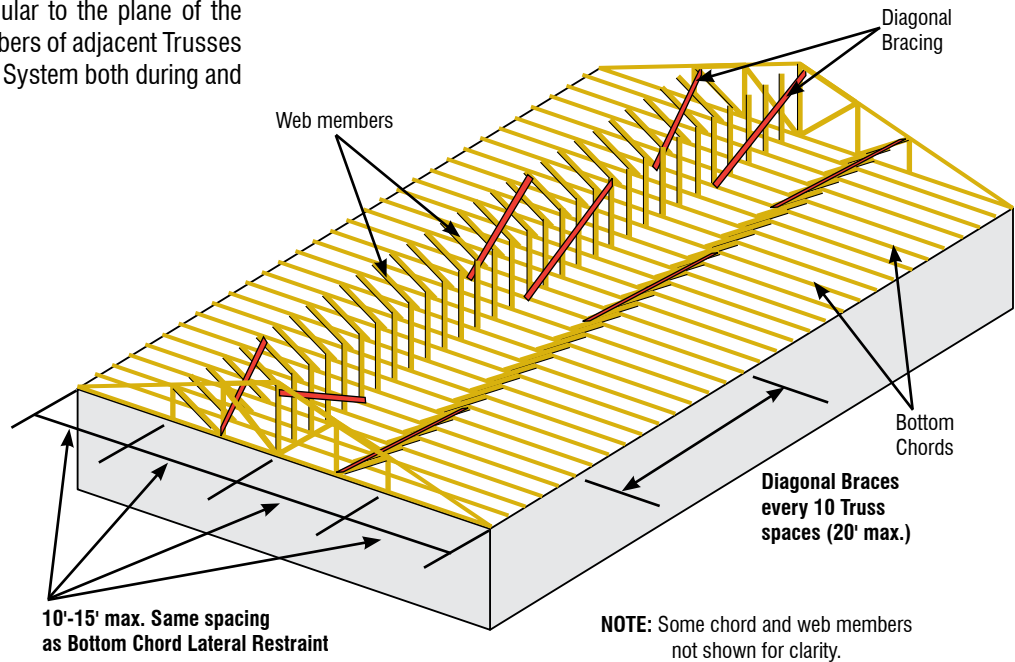


FIGURE B2-34

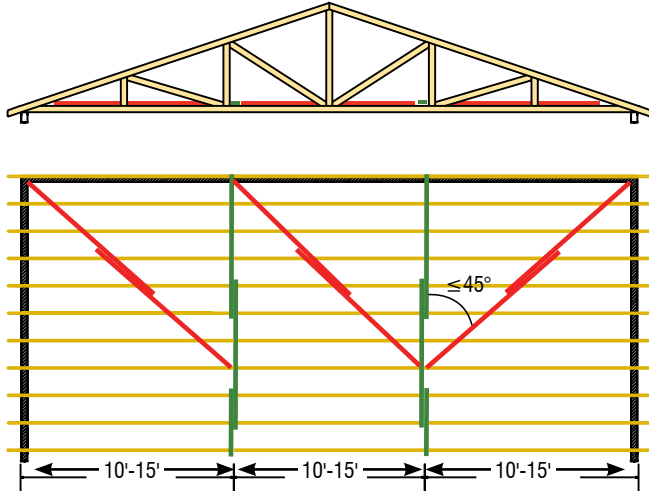
- ✓ **IMPORTANT NOTE:** Diagonal Bracing is critical in preventing Trusses from leaning or dominoing. Repeat as shown to create a succession of rigid units. Mono Trusses, deep flat Trusses and other types of Trusses with deep ends also require Temporary Lateral Restraint and Diagonal Bracing on the long web members at the deep end of the Truss.
- ✓ Consult the Building Designer during the pre-erection meeting if the Temporary Lateral Restraint, Diagonal Bracing and PBSB requirements are not perfectly clear.

### STEP 7. LATERAL RESTRAINT & DIAGONAL BRACING FOR THE BOTTOM CHORD PLANE

- ✓ Bottom Chord Temporary Lateral Restraint (BCTLR) and Diagonal Bracing are used to stabilize the Bottom Chords during Truss installation and to maintain proper spacing between Trusses. They also can be used as PBSB. Therefore, most BCTLR and Diagonal Bracing is placed on the top edge of the Bottom Chords and fastened with a minimum of two nails (see page 21 for minimum sizes) at each Truss intersection, at the locations specified for the PBSB and becomes part of the PBSB system.



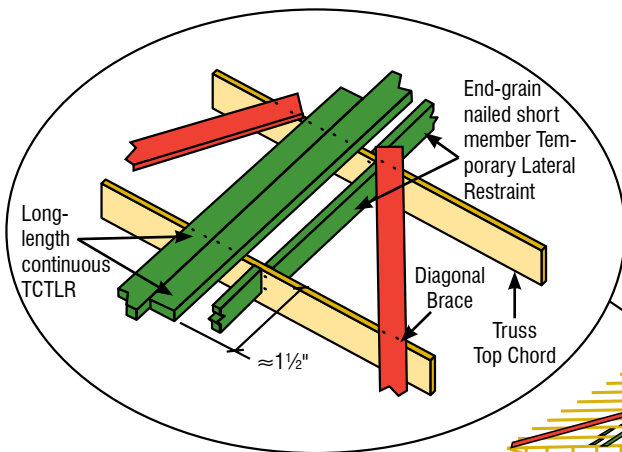
## BCSI-B2: Truss Installation & Temporary Restraint/Bracing



Plan view of Bottom Chord Lateral Restraint and Diagonal Bracing. Top Chord and Web Lateral Restraint and Diagonal Bracing not shown for clarity.

FIGURE B2-35

- ✓ Bottom Chord **TEMPORARY** Lateral Restraint (BCTLR) shall be installed as continuous rows spaced no more than 15' on-center and can only be removed (if desired) after the permanent Ceiling Diaphragm is in place.
- ✓ Bottom Chord **PERMANENT** Lateral Restraint (BCPLR) shall be installed as continuous rows spaced no more than 10' on-center or less if required by the specific Truss design and/or the Building Designer. Temporary Lateral Restraint installed at the required spacing of the permanent Lateral Restraint (see TDD for spacing), and left in place, can become part of the PBSB system.



**NOTE:** Ends of TCTLRs can also be attached to each other using CLR splice reinforcement. Refer to Figure B1-28 for more information.

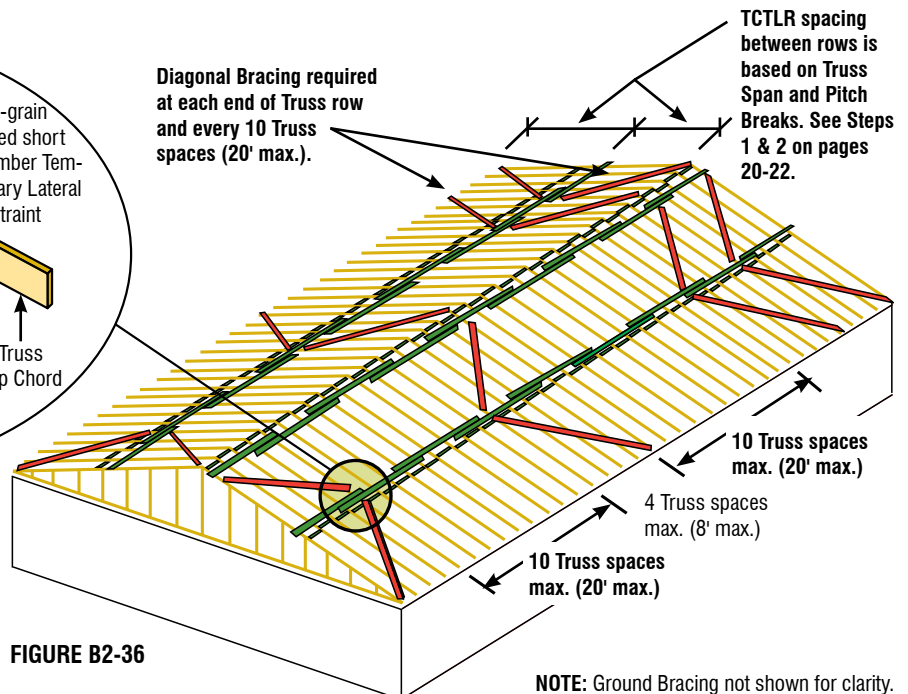


FIGURE B2-36

**NOTE:** Ground Bracing not shown for clarity.

- ✓ The Building Designer specifies how the Bottom Chord Lateral Restraint is to be braced to prevent lateral movement and become part of the PBSB system. This can be accomplished by Diagonal Bracing in the Bottom Chord Plane repeated at the same intervals as the Top Chord Diagonal Bracing (see also **BCSI-B1**, pages 12-13); or other means as determined by the Building Designer.

### STEP 8. CONTINUE THE TRUSS INSTALLATION PROCESS REPEATING STEPS 4 THROUGH 7 WITH GROUPS OF FOUR TRUSSES USING OPTION A OR B BELOW.

**OPTION A: Long-length continuous Top Chord Temporary Lateral Restraints shall have Diagonal Braces a maximum of every 20'. See detail below:**

- ⚠ **WARNING** This Diagonal Bracing option can only be used if the Contractor installs long-length continuous TCTLR as indicated in Step B below.

Step A: Install the next four Trusses using Short Member Temporary Lateral Restraint options 1-3 from page 24.

Step B: Add long-length (min. 2 x 4 x 12') Continuous Lateral Restraints (CLR) to tie all Trusses together. Overlap the ends of the CLR by at least two Trusses.

Step C: Add Diagonal Bracing (at  $\approx 45^\circ$ ) as indicated in Figure B2-36:

## BCSI-B2: Truss Installation & Temporary Restraint/Bracing

**OPTION B: Short Member Temporary Lateral Restraints require Diagonal Braces attached to all Trusses. See details below:**

**⚠ WARNING** After the initial group of five Trusses are installed and braced (i.e., Lateral Restraint and Diagonal Bracing), **DO NOT** set more than four Trusses when using Short Member Temporary Lateral Restraint before you **STOP** and Diagonally Brace as shown. **Option (B) will NOT work without Diagonal Bracing installed with each group of four Trusses.**

Spacing between rows of TCTLR is based on Truss Span and Pitch Breaks. See Steps 1 & 2 on pages 20-22.

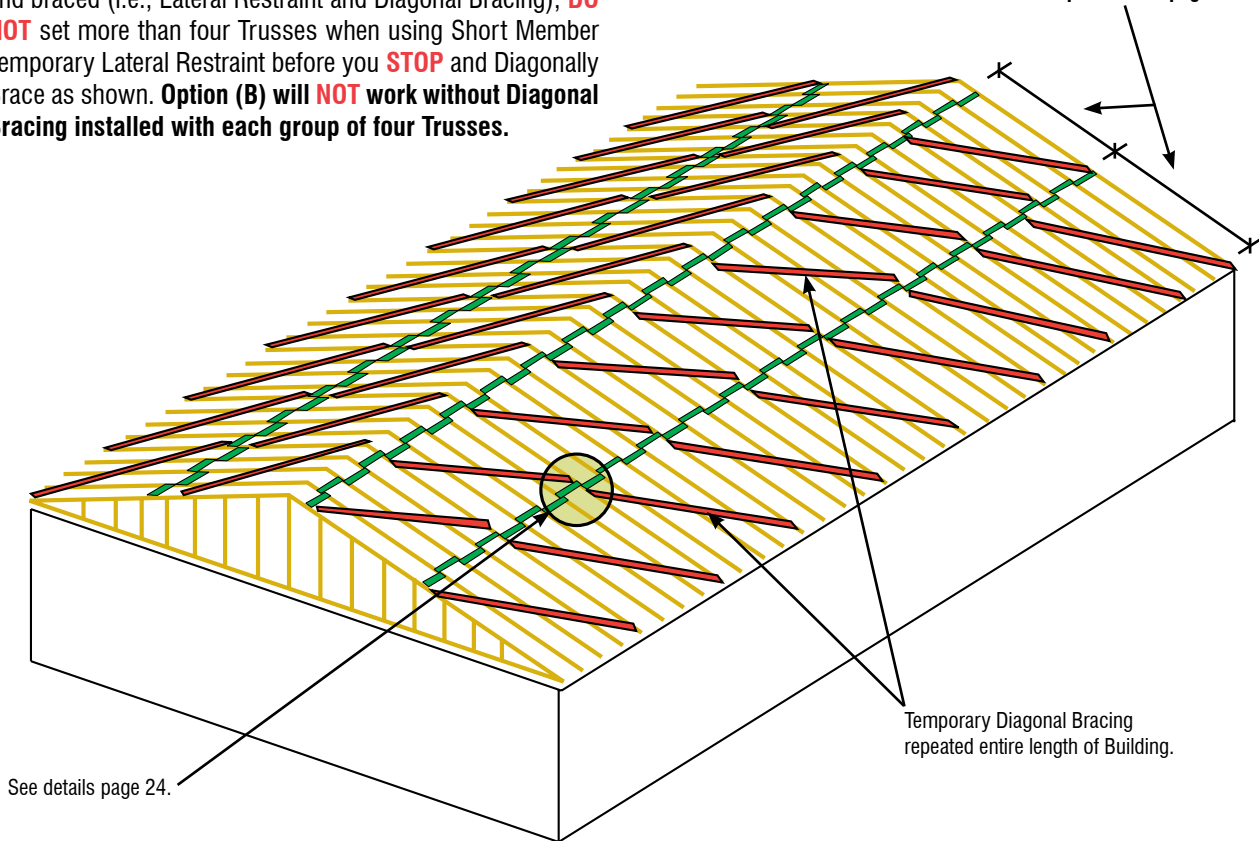


FIGURE B2-37

**⚠ WARNING** TCTLR, either continuous or short member, is ALWAYS to be used WITH Diagonal Bracing!



Improper bracing scheme - Continuous TCTLR without Diagonal Bracing

PHOTO B2-6



Proper bracing scheme - Continuous TCTLR with Diagonal Bracing.

PHOTO B2-7

**ENSURE THAT ALL TRUSSES ARE PROPERLY DIAGONALLY BRACED**

✓ Apply Structural Sheathing early and often. Do not wait until all Trusses are set to apply Structural Sheathing.

**⚠ CAUTION** Remove only as much 2x4 Bracing as is necessary to nail down the next sheet of Structural Sheathing.

**⚠ CAUTION** Do not exceed Truss Design Load with construction Loads (see **BCSI-B4**).



PHOTO B2-8

### ALTERNATE INSTALLATION METHOD

Build it on the ground and lift it into place.

- ✔ Ensure level bearing and follow the procedures described in Steps 1-8 on pages 20-28, **except** set, position, plumb, and properly restrain and brace the Trusses as modules on the ground. Lift note: Depending upon the job specifics, it may be possible to construct the entire roof on the ground and lift into place as a single unit.
- ✔ Be sure to install all Top Chord, Web Member, and Bottom Chord Lateral Restraint and Bracing prior to lifting.
- ⚠ **CAUTION** Additional restraint and bracing may be required to safely lift units into place.
- ✔ Be sure to get the proper guidance from a Registered Design Professional to ensure modules are designed and installed safely and properly.



Ground Bracing for Truss assembly being built on the ground.

**PHOTO B2-9**



Install Structural Sheathing as soon as the first "set" of Trusses have been properly plumbed, restrained and braced. Begin at the heel and alternate 4'x8' and 4'x4' sheets up to the peak.

**PHOTO B2-10**



Install Web Member Permanent Lateral Restraint and Diagonal Bracing (or web reinforcement) and Bottom Chord Permanent Lateral Restraint and Diagonal Bracing as required.

**PHOTO B2-11**



Pick up the finished assembly and set it into place.

**PHOTO B2-12**

## HIP SET ASSEMBLY & BRACING

A Hip Set is the series of Trusses that decrease in height to form the end slope of a hip roof. Hip Sets are laid out in a variety of ways but, for the most part, they have a hip Girder Truss that is set back from the end wall a certain distance and perpendicular end jacks that span the setback distance. Permanently connecting the end jacks to the end wall and Girder Truss as early in the installation process as possible dramatically increases the stability of the hip Girder Truss and the safety of the structure.

**NOTE:** Truss restraint and bracing not shown for clarity.

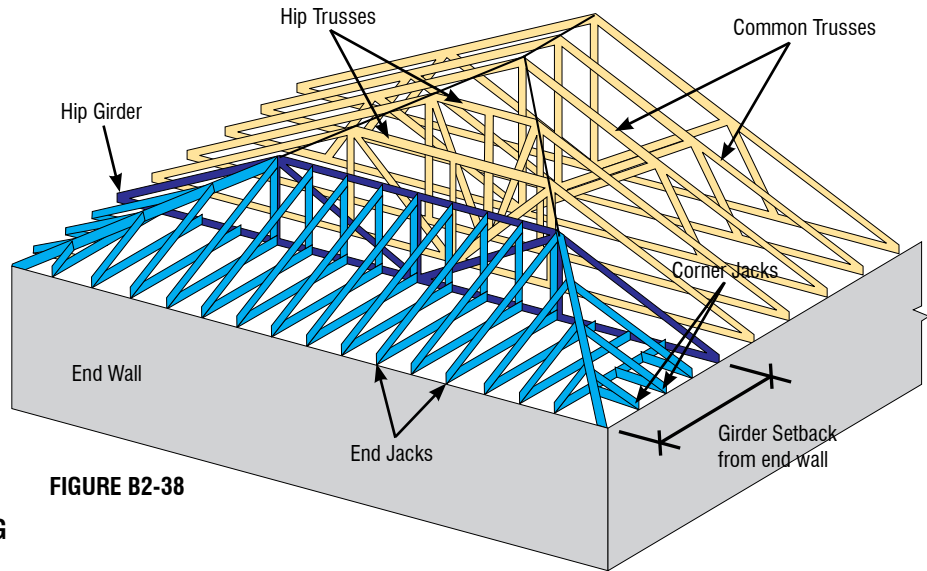


FIGURE B2-38

## STEPS FOR HIP SET ASSEMBLY & BRACING

**Step 1:** Position the hip Girder Truss on the bearing walls at the specified end wall setback. If the hip Girder Truss consists of multiple plies, it is much easier to fasten the plies together and install the end jack hangers (if required) on the ground before lifting the Girder Truss into place. Permanently attach the Girder Truss to bearing supports. **Note:** All plies of a multi-ply Girder Truss shall be attached per the fastening schedule on the TDD before attaching any framing members or applying any Loads.

**Step 2:** Install all remaining corner and end jacks with all permanent Truss-to-bearing Connections (e.g., hangers, clips and tie-downs).

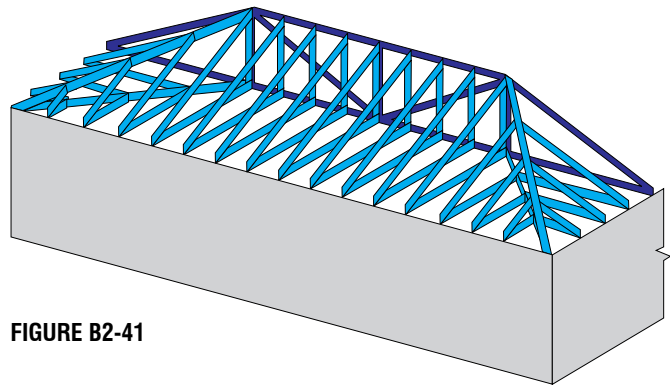


FIGURE B2-41

Install jacks while crane continues to hold Girder Truss in place.

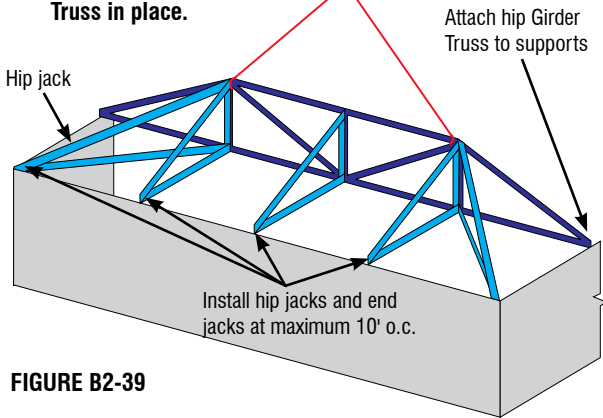


FIGURE B2-39

Per the TDD, attach jack Trusses to the Top and Bottom Chord of the Girder Truss. The Connection at the top is important during Truss installation as it helps to stabilize the Top Chord of the Girder Truss.

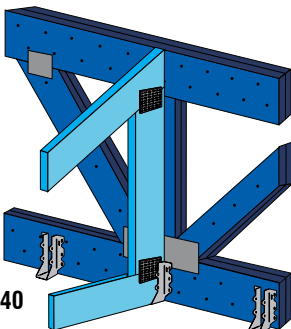


FIGURE B2-40

**Alternate Option to Step 1 & 2:** Assemble the Girder Truss and jacks on the ground and lift the entire assembly into place. Be sure to get guidance from a Registered Design Professional to ensure modules are designed and installed safely and properly (see page 29 for information on an alternative installation method).

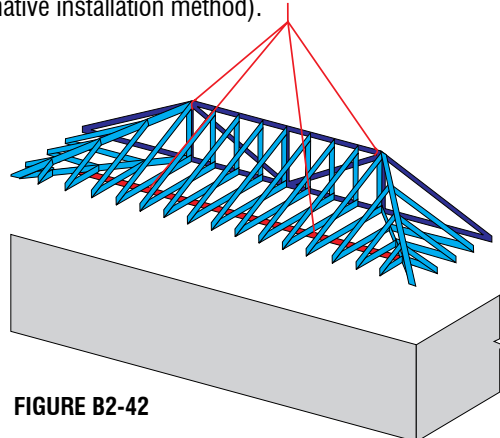


FIGURE B2-42

## BCSI-B2: Truss Installation & Temporary Restraint/Bracing

**Step 3:** Install the next Hip Truss with 2x4 Short Member Temporary Lateral Restraints. Attach each Short Member Temporary Lateral Restraint to the Top Chord of the hip Girder Truss and adjacent Hip Truss with two nails at each connection. The Short Member Temporary Lateral Restraints should be long enough to extend at least 1-1/2" past the Top Chord of each Truss. Place Short Member Temporary Lateral Restraint at pitch breaks and along the Top Chords and space rows according to the guidelines provided in Table B2-1.

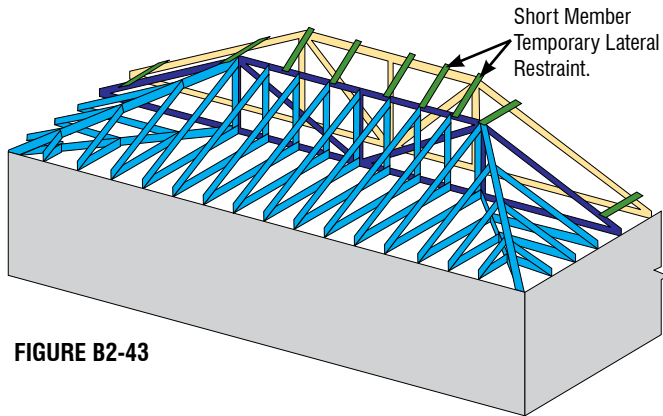


FIGURE B2-43

**Step 4:** Install remaining Hip Trusses. For the flat portion of each Hip Truss, use Short Member Temporary Lateral Restraints that are at least double the length of the first set of Short Member Temporary Lateral Restraints. For the sloped chords of the Trusses, install Short Member Temporary Lateral Restraints according to one of the three options on page 24.

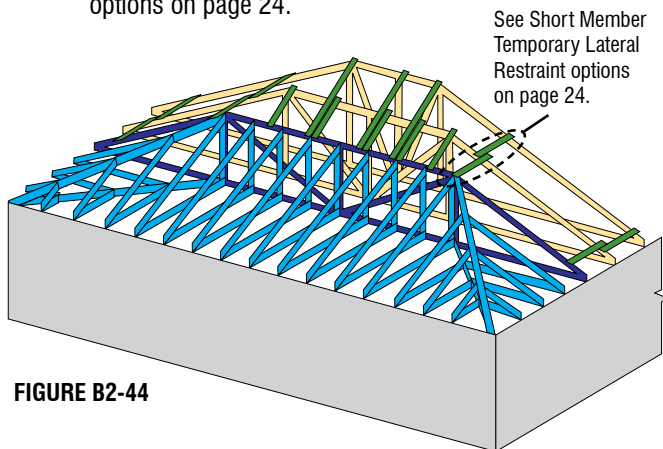


FIGURE B2-44

**Step 5:** Install pitched Trusses using the guidelines of this document.

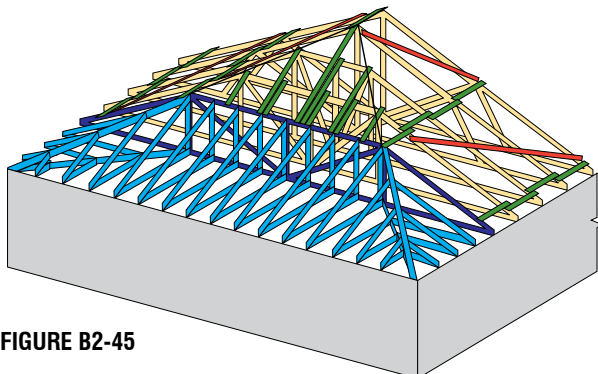


FIGURE B2-45

- ✓ If there is a hip at one end of the Building and a gable at the other, a good practice is to start the Truss installation at the hip end.

**Note:** Lateral Restraint and Diagonal Bracing not shown for clarity.

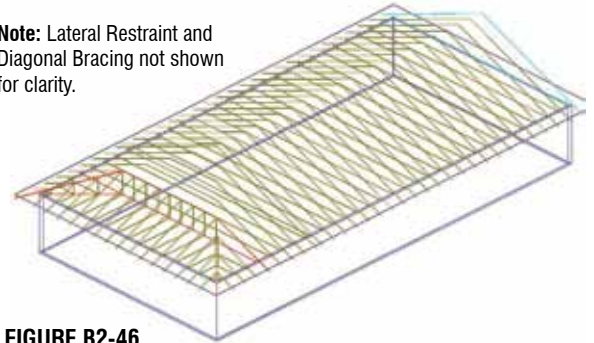


FIGURE B2-46

- ⊘ **DON'T** stack materials or stand on end jacks as this causes instability in the hip Girder Truss.

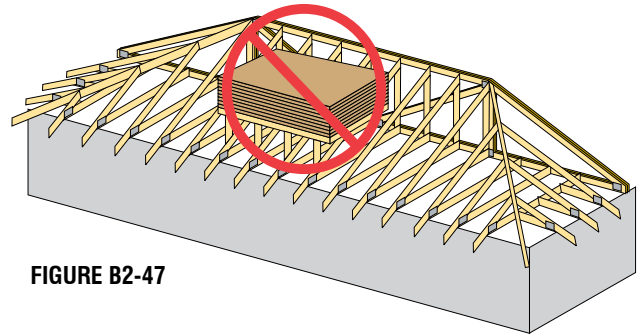


FIGURE B2-47

### LONG SPAN TRUSS INSTALLATION

**⚠ DANGER** Long Span Trusses are extremely dangerous to install.

**Long Span Trusses, i.e., Trusses with clear spans 60' or greater, pose significant risk to installers.** The dimensions and weight of a Long Span Truss can create instability, buckling and collapse of the Truss if it is not handled, installed, restrained and braced properly. Long Span Trusses can be installed safely and efficiently, but **they require more detailed safety and handling measures than shorter span Trusses.**



PHOTO B2-13

#### *Before Starting*

- **Hire a Registered Design Professional** to provide a Temporary Restraint/Bracing plan and to supervise the erection process.
- Read and understand this guide.
- Develop a safe, effective Truss installation method and inform all crew members of their roles.
- **Use personnel who have experience installing Trusses 60' and greater in span.**
- Inspect the Trusses.
- Document all Truss damage. Prior to installation, repair all Trusses according to the repair details prepared by the Truss Designer or a Registered Design Professional.
- Ensure that the walls and supporting structure are stable and adequately restrained and braced.

- Have all necessary lifting equipment and building materials on hand. Make sure the crane operator understands the special hoisting requirements of Long Span Trusses (see **BCSI-B1** Figures B1-12A and 12B, page 9).

#### *Tips for Safe and Efficient Installations*

- ✓ **Build the First Five Trusses Into a Stable Base Unit:** Assemble the first five Trusses with all Structural Sheathing, restraint and Bracing. Some installers lift the first five Trusses one at a time and restrain, brace and sheath as they go. Other installers build the base unit on the ground and lift it into place. Either way, this makes the installation process much easier, accurate and safe (see Figure B2-48).

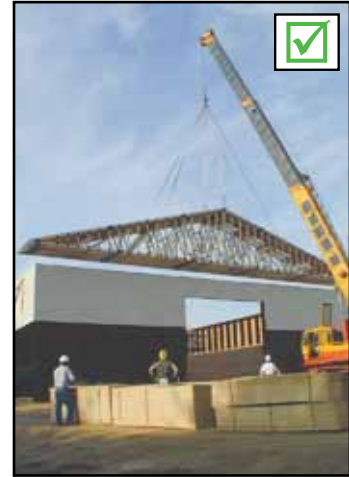


PHOTO B2-14

- ✓ **Add a Temporary Center Support:** It is highly recommended that temporary supports be set up at interior locations during the erection/installation process. This will provide greater stability and increased safety at the jobsite. Temporary interior supports should be left in place until all PBSB has been installed.

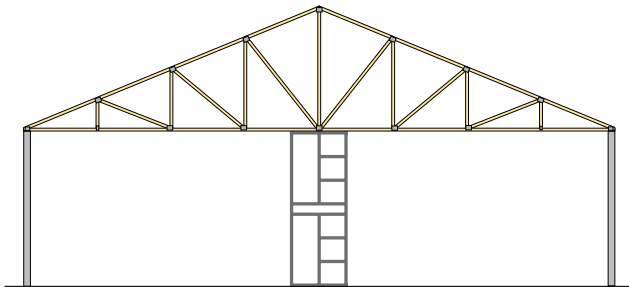


FIGURE B2-49

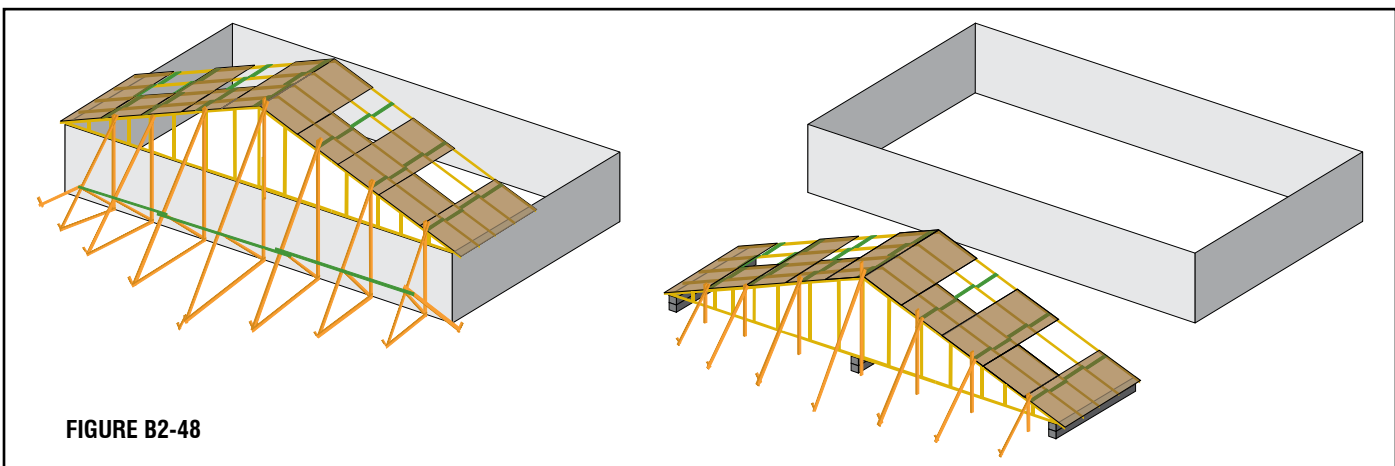


FIGURE B2-48

- ✔ **Keep Trusses Straight During Hoisting:** Long Span Trusses are very prone to bending out-of-plane while being lifted into place. It is very important to provide support so the Trusses flex as little as possible. A good hoisting device and Spreader Bar can provide support and be a real time saver.



PHOTO B2-15

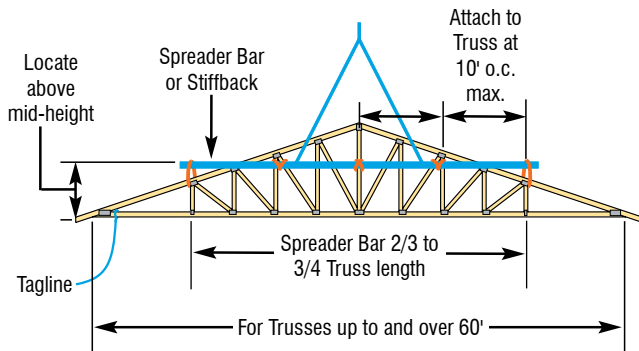


FIGURE B2-50A

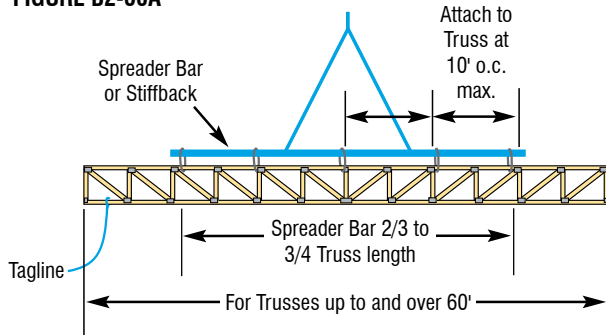


FIGURE B2-50B

- ✔ **Sheath the Top Chord as Trusses Are Installed:** Save time by applying Structural Sheathing immediately. Installation is also safer when the crew can work from a sheathed deck.



PHOTO B2-16

- ✔ **Install All Permanent Individual Truss Member Restraint/Bracing Immediately:** Once the installation crew becomes familiar with the procedure, the Permanent Lateral Restraint and Diagonal Bracing for Webs and Bottom Chords can be installed in the time it takes to release the hoist and install the next Truss.



PHOTO B2-17

Visit [sbcindustry.com/longspan.php](http://sbcindustry.com/longspan.php) for a detailed handling and installation strategy, articles on Long Span Truss installations, and more resources for temporary and permanent restraint/Bracing of Trusses.

**NOTICE** Contractor experience is required to install Trusses 60' and greater in span.

**DISCLAIMER:** The Truss Manufacturer and Truss Designer rely on the fact that the Contractor and crane operator (if applicable) are capable to undertake the work they have agreed to do on a particular project. The Contractor should seek any required assistance regarding construction practices from a competent party. The methods and procedures outlined are intended to ensure that the overall construction techniques employed will put floor and roof Trusses in place SAFELY. These recommendations for handling, installing, restraining and Bracing Trusses are based upon the collective experience of leading personnel involved with Truss design, manufacturing and installation, but must, due to the nature of responsibilities involved, be presented only as a guide for use by a qualified Building Designer and/or Contractor. It is not intended that these recommendations be interpreted as superior to the Building Designer's design specification for handling, installing, restraining and Bracing Trusses and it does not preclude the use of other equivalent methods for restraining/Bracing and providing stability for the walls, columns, floors, roofs and all the interrelated Structural Building Components as determined by the Contractor. Thus, SBCA, TPI and those who participated in the development of this guide expressly disclaim any responsibility for damages arising from the use, application, or reliance on the recommendations and information contained herein.

## FIELD ASSEMBLY & OTHER SPECIAL CONDITIONS

Certain sizes or shapes of Trusses require some assembly at the jobsite. Refer to the Truss Design Drawings (TDD) for specific instructions on assembly methods, unless the Construction Documents indicate otherwise. The Contractor is responsible for proper field assembly.

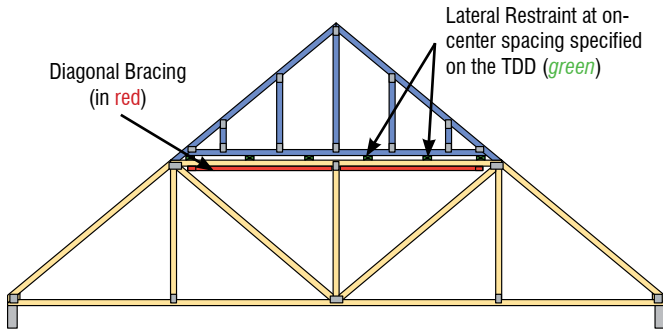
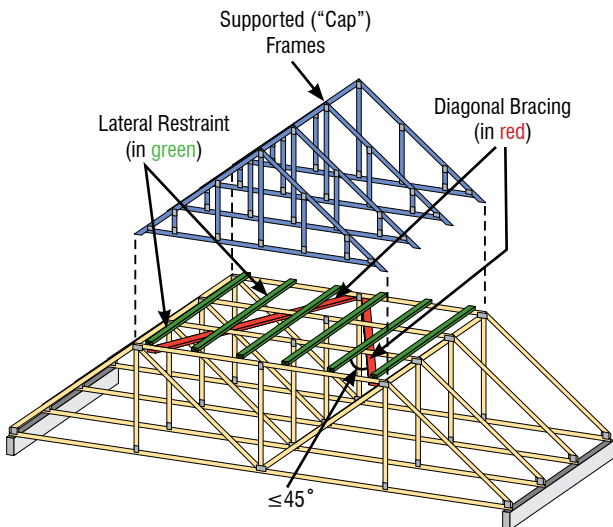


FIGURE B2-51

### Piggyback Trusses

Profiles that are too tall to be delivered to the jobsite in one piece may be designed and manufactured in two or more layers and “piggybacked” at the jobsite. Install all Temporary Lateral Restraint and Diagonal Bracing in accordance with the Building Designer’s Temporary Installation Restraint/Bracing plan or the procedures outlined herein. Install all Permanent Individual Truss Member Restraint (PITMR) shown on the TDD and PBSB shown on the Construction Documents. The supporting Trusses shall be completely installed with all Truss member and PBSB as required BEFORE installing the supported (“Cap”) Frames.

For details on how to permanently laterally restrain and diagonally brace Piggyback Truss Systems, refer to [BCSI-B3](#).



**Note:** Some Lateral Restraint and Diagonal Bracing not shown for clarity.

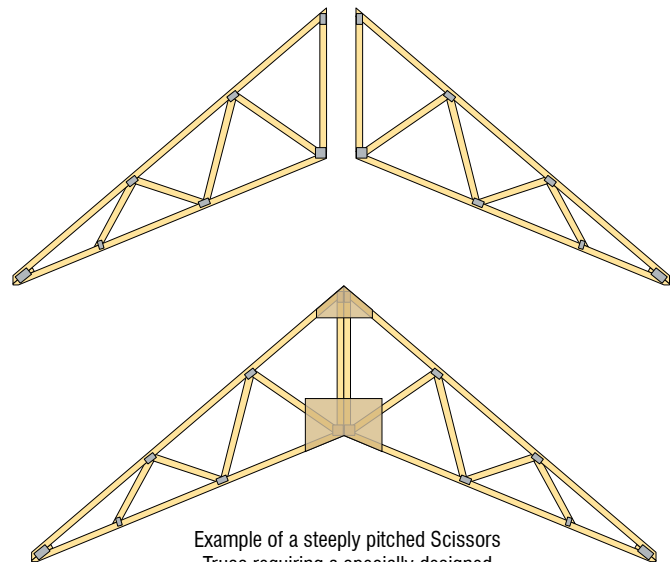
FIGURE B2-52

### Field Spliced Trusses

Trusses that are too long or too tall for delivery to the jobsite in one piece are designed to be delivered in two or more parts, and then field spliced together on the jobsite. Splicing can be performed on the ground before installation, or the Truss sections can be supported by temporary shoring after being hoisted into place and the splices installed from a safe working surface. Temporary Lateral Restraint and Diagonal Bracing must be installed per the recommendations provided in this document and PBSB per the Construction Documents as the Trusses are installed.



PHOTO B2-18



Example of a steeply pitched Scissors Truss requiring a specially designed field splice at the top and bottom peak. See TDD for splice details.

FIGURE B2-53



- ✔ Some Buildings are designed to have open ends (no end walls) or large door openings in the end walls. Apply Diagonal Bracing to the Bottom Chords between the rows of Bottom Chord Lateral Restraint and at approximately 45° to the laterals (see Figure B2-35, page 27). Apply this Diagonal Bracing at both ends of an open end building, and repeat along the length of the Building at the same spacing as determined for the Top Chord Diagonal Braces. Such Buildings may also require additional Bottom Chord Permanent Building Stability Bracing to resist buckling of the Bottom Chord due to compression forces caused by wind uplift. Consult the Building Designer.

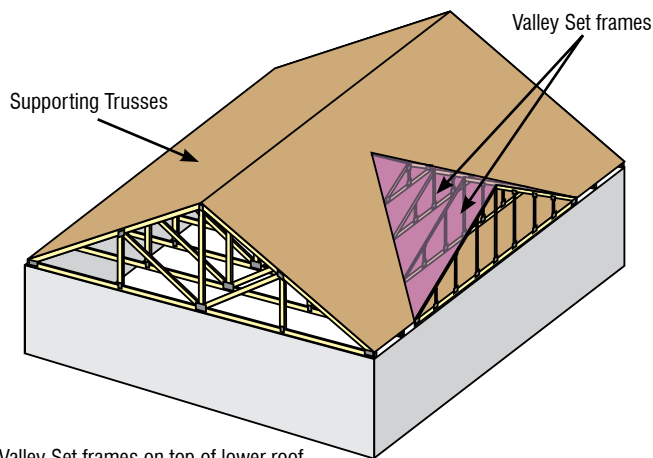
### Multi-Ply Trusses & Girder Trusses

**NOTICE** The proper attachment of Truss plies in Multi-Ply Trusses is required along the entire length of the Truss. The Truss Designer specifies the specific ply-to-ply Connections required for chords and Webs on the TDD. If possible, connect Multi-Ply Trusses together in accordance with the TDD prior to erection/installation.

**NOTICE** Girder Truss plies shall be completely and securely attached together prior to attaching the supported Trusses to the Girder Truss (see **BCSI-B9**).

- ✔ Attach Lateral Restraint and Diagonal Bracing to each ply of a Multi-Ply Truss.

### VALLEY SET FRAME INSTALLATION

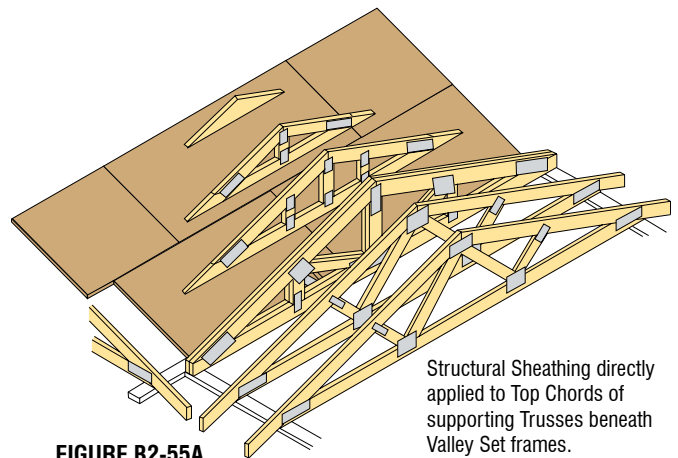


Valley Set frames on top of lower roof.

**FIGURE B2-54**

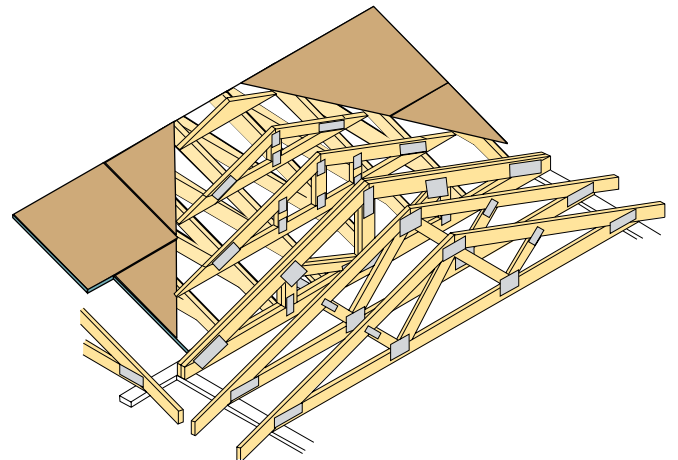
- ✔ A Valley Set is a group of Truss frames designed to sit on top of other Trusses to change the direction of the roof planes.

- ✔ The Top Chord of the supporting Trusses beneath the Valley Set frames shall be laterally restrained and Diagonally Braced by either Structural Sheathing or other alternate methods as specified by the Building Designer. If Structural Sheathing is not installed, the Top Chords of the supporting Trusses shall be braced by the Valley Set frames, or with rows of Lateral Restraint, spaced no more than the maximum o.c. spacing specified on the TDD, and Diagonal Bracing.



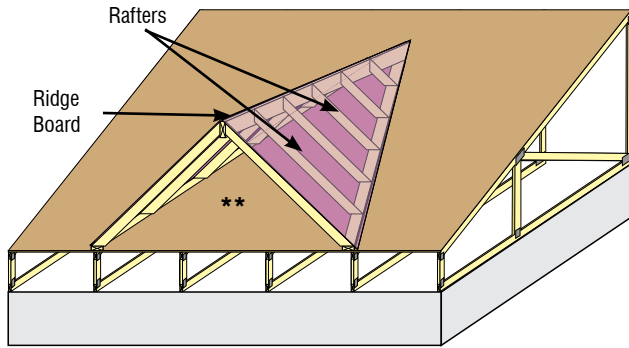
**FIGURE B2-55A**

Structural Sheathing directly applied to Top Chords of supporting Trusses beneath Valley Set frames.



No Structural Sheathing attached to the Top Chords of the supporting Trusses beneath the Valley Set frames. The on-center spacing of the Valley Set frames, as measured along the slope of the Top Chord of the supporting Trusses, must be less than or equal to the maximum Purlin spacing specified on the TDD for the Top Chord of the supporting Trusses. Add Diagonal Bracing to the Top Chord Plane of the supporting Trusses if the Valley Set frames are  $\geq 20'$  in length.

**FIGURE B2-55B**



For conventionally framed dormers, as shown in this figure, the Top chords of the supporting Trusses beneath the dormer must be restrained and Braced with Structural Sheathing, as shown, or with rows of Lateral Restraint and Diagonal Bracing, to prevent buckling under Load. See NOTE below for assumed flow of Loads to Trusses depending on the method used to frame a valley.

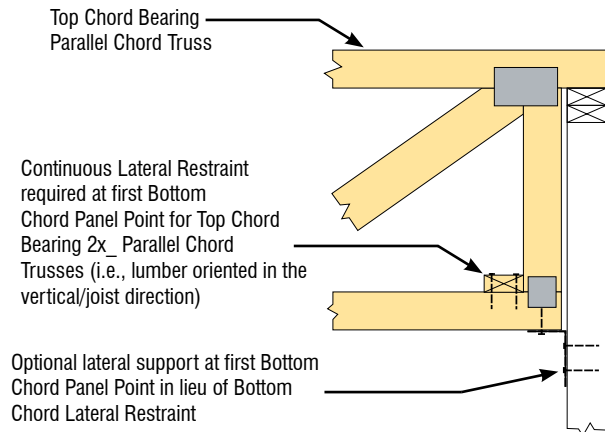
**FIGURE B2-56**

**\*\*NOTE:** The method used to frame a valley will affect how the Loads from the upper roof are distributed to the supporting Trusses, and therefore, how these Trusses are to be designed. Valley Set frames (Figure B2-54 on page 35) spaced at 24" o.c. or less distribute the upper roof Load uniformly to the lower roof. Valley Set frames spaced at more than 24" o.c. distribute the upper roof Load to the lower roof as a series of concentrated line Loads applied to the lower roof at the location of each Valley Set frame. Conventional Framing without intermediate supports (Figure B2-56) distributes the upper roof Load to the lower roof as a concentrated line Load acting along the valley created at the intersection of the two roofs. In order to distribute the roof Load from a conventionally framed valley uniformly to the supporting Trusses below, 2x\_ vertical studs must be installed between the valley member and the top of the lower roof deck. Install each stud directly over the Top Chords of the Trusses at a maximum spacing of 4' o.c. along the ridge board and each rafter. Install rows of Lateral Restraint to top of roof deck directly beneath and parallel to each rafter for attachment of bottom end of vertical studs.

### SPECIAL APPLICATIONS USING TRUSSES

**⚠ CAUTION** Trusses installed for ornamental purposes or other special applications, and that are not intended to carry roof Loads, floor Loads, or exterior environmental Loads such as snow or wind, still require Bracing to prevent lateral buckling due to self weight, incidental material Loads (e.g., from lattice work or other finished framing) and installation forces. Even very small Loads may cause lateral buckling in members that do not have adequate Bracing. The Contractor is advised to adhere to the Lateral Restraint requirements specified on the TDD, and install Diagonal Bracing or Structural Sheathing to brace these areas.

### OTHER APPLICATIONS REQUIRING SPECIAL RESTRAINT/BRACING



**FIGURE B2-57**

- ✓ For Top Chord Bearing, 2x\_, Parallel Chord Trusses, install Continuous Lateral Restraint at the first Bottom Chord Panel Point to prevent torsional overturning under Load (see Figure B2-57). Consult the TDD for Trusses with lumber oriented in the 3x\_ or 4x\_ (i.e., horizontal, flat or plank) direction.
- ✓ For Bottom Chord Bearing Parallel Chord Trusses that are properly anchored to the supports, the Bottom Chord Lateral Restraint is not required at the first Bottom Chord Panel Point.

## PERMANENT RESTRAINT/BRACING OF CHORDS & WEB MEMBERS

**NOTICE** Proper installation of Trusses is extremely critical to the lifetime performance of the Building. Depending on the experience of the Contractor<sup>1</sup> it is strongly recommended that a meeting be held with the Building Designer<sup>1</sup> to ensure that all Permanent Building Stability Bracing (PBSB) is identified and will be properly installed and to review the provisions of:

- the Construction Documents (i.e., architectural/structural plans and specifications)
- the Truss Submittal Package, which includes:
  - the Truss Design Drawings (TDD)
  - the Truss Placement Diagram(s) (if/when required by the Contract)
- this BCSI document and/or B-Series Summary Sheets (when provided)
- site-specific conditions
- any specific Truss member Permanent Bracing plans that are provided for the roof or floor structural system,
  - all special Permanent Bracing conditions such as un-sheathed Top Chords, Long Span Scissors Trusses, Piggyback Truss Systems, and all 60' or greater clear span systems

**⚠ WARNING** Disregarding Permanent Individual Truss Member Restraint and Permanent Building Stability Bracing recommendations is a major cause of Truss field performance problems and has been known to lead to collapsed roof and/or floor systems. Failure to install the proper restraint and Bracing will greatly increase the probability of Truss performance problems or an accident resulting in property damage, personal injury or death.

Trusses, as with other types of structural framing components such as joists, beams, studs, etc. require lateral support in order to perform in the manner for which they are intended. Trusses are designed to carry Loads applied within their plane. Trusses are not designed to resist lateral (i.e., out-of-plane) Loads and rely on PBSB to transfer the lateral loads out of the Truss System into the supporting structure. Certain individual Truss members also require Lateral Restraint and Bracing to prevent buckling under the applied design Loads. Permanent Bracing provides sufficient support at right angles to the plane of the Truss to hold every Truss member in the position assumed for it in the design. Permanent Lateral Restraint and Bracing is needed for the proper performance of individual Trusses within the roof or floor system.

Provisions for Permanent Individual Truss Member Restraint (PITMR) are provided in Section 2303.4 of the 2012 Inter-

national Building Code® (IBC®) (see also Chapter 2 of ANSI/TPI 1) where it is stated:

### 2303.4.1.1 Truss design drawings...

13. Maximum axial tensile and compression forces in the Truss members; and
14. Required permanent individual Truss member restraint location and the method and details of restraint/bracing to be used in accordance with Section 2303.4.1.2.

**2303.4.1.2 Permanent individual Truss member restraint.** Where permanent restraint of Truss members is required on the Truss design drawings, it shall be accomplished by one of the following methods:

1. Permanent individual Truss member restraint/bracing shall be installed using standard industry lateral restraint/bracing details in accordance with generally accepted engineering practice. Locations for lateral restraint shall be identified on the Truss design drawing.
2. The Trusses shall be designed so that the buckling of any individual Truss member is resisted internally by the individual Truss through suitable means (i.e., buckling reinforcement by T-reinforcement or L-reinforcement, proprietary reinforcement, etc.). The buckling reinforcement of individual members of the Trusses shall be installed as shown on the Truss design drawing or on supplemental Truss member buckling reinforcement details provided by the Truss designer.
3. A project-specific permanent individual Truss member restraint/bracing design shall be permitted to be specified by any *registered design professional*.

As defined in many engineering laws and building codes, the Building Designer is responsible for the overall design and flow of Loads through the building. This includes what is called the PBSB for the Trusses. The PBSB resists forces acting perpendicular to the plane of the Trusses due to gravity, Seismic and/or Wind Loads, as well as collective forces caused by the restraint of members subject to buckling. To aid in the design of the PBSB, the TDD includes the information provided in IBC 2303.4.1.1 Items 13 and 14 (see above) to assist the Registered Design Professional (RDP) in generating the appropriate engineering calculations.

<sup>1</sup> See Glossary of Terms for definitions of Building Designer and Contractor.

## BCSI-B3: Permanent Restraint/Bracing of Chords & Web Members

In accordance with most engineering laws and the Building code, the Building Designer should review the TDD submittals to verify that all the components and their placement comply with his/her written engineering requirements.

### RESTRAINT/BRACING MATERIALS & FASTENERS

- ✓ The material and fasteners used to restrain and brace Trusses shall be of sufficient strength and stiffness to hold every Truss member in the position assumed for it in the design.
- ✓ Some of the more common materials used to brace the members of Trusses include wood structural panels, gypsum board sheathing, dimension lumber, Proprietary Metal Restraint/Bracing Products, and metal Purlins and straps, to name a few.
- ✓ Minimum size Restraint/Bracing material is 2x4 stress-graded lumber, unless another size is specified by the Building Designer.

Minimum Nail Size
10d (0.128x3")
12d (0.128x3.25")
16d (0.131x3.5")

TABLE B3-1

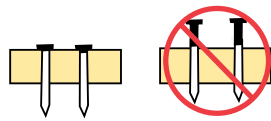


FIGURE B3-1

- Use at least 2-10d (0.128x3"), 2-12d (0.128x3.25"), or 2-16d (0.131x3.5") nails to attach 2x4 Lateral Restraint and Diagonal Bracing members at each Connection as specified by the Truss Design or Building Designer. For 2x6 or greater Lateral Restraint and Diagonal Bracing, use a minimum of three nails per Connection.

### USING TEMPORARY RESTRAINT/BRACING AS PERMANENT RESTRAINT/BRACING

BCSI-B2 provides important information and guidelines on Temporary Installation Restraint/Bracing of Trusses. Many elements of Temporary Restraint/Bracing of Trusses also apply to Permanent Restraint/Bracing of Trusses. Temporary Restraint/Bracing of Trusses provides support to the Trusses during installation. Permanent Restraint/Bracing of Trusses provides support to the Trusses during the lifetime of the structure and resists the applied Loads anticipated during that lifetime. If properly planned, much, if not all, of the Temporary Restraint/Bracing installed during Truss installation can be used to permanently restrain and brace the Truss, making the completion of the PBSB system more efficient.

### PERMANENT BRACING FOR THE VARIOUS PLANES OF A ROOF TRUSS

Permanent Bracing applied at right angles to the plane (i.e., depth) of a Truss performs several functions including:

- a) Preventing out-of-plane buckling of certain Truss members due to compression forces developed under the specified design Load conditions
- b) Maintaining the proper Truss Spacing
- c) Resisting and transferring the lateral Loads applied to the Truss System (e.g., wind, seismic, etc.)

Trusses are designed to only support Loads applied within their plane. Because Trusses are relatively narrow in relation to their depth and span, they require lateral support. Without this support, the entire Truss, or a portion of its members, will buckle (i.e., fail) at Loads far less than the design Loads that they were intended to carry.

Trusses require Permanent Bracing within ALL of the following planes:

1. Top Chord Plane
2. Bottom Chord Plane
3. Web Member Plane

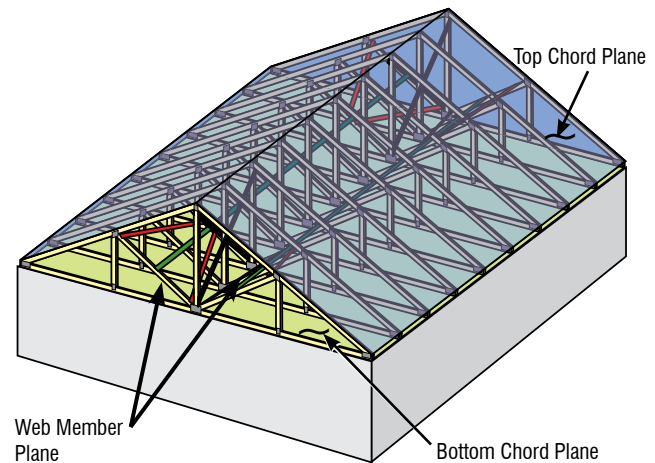


FIGURE B3-2

#### 1. PERMANENT BRACING FOR THE TOP CHORD PLANE

- ✓ Permanent Bracing for the Top Chords of Trusses is typically provided by attaching Structural Sheathing, or wood or metal structural Purlins that are properly braced.
- ✓ The most common types of Structural Sheathing are wood structural panels such as plywood or oriented strand board (OSB).
- ✓ The wood structural panels shall have the appropriate span rating and/or grade to support the Building Designer's Specified Loads at the on-center (o.c.) spacing of the Trusses.

- ✓ The sheathing and attachment requirements (i.e., fastener size and spacing) are provided on the Construction Documents prepared by the Building Designer and/or within the Building code.

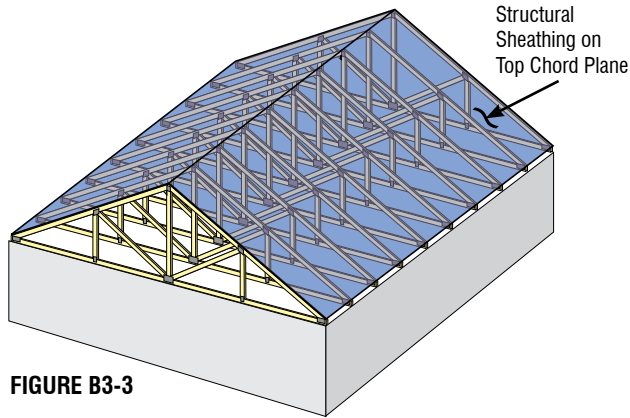
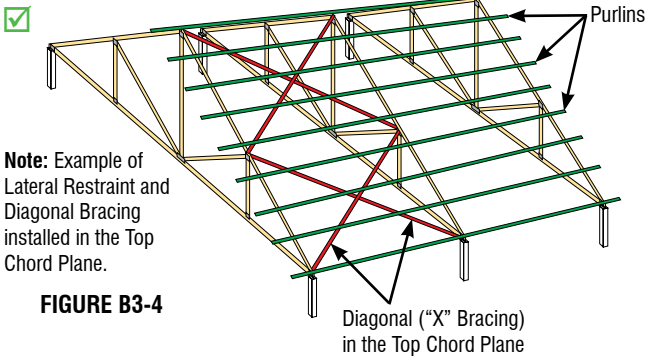


FIGURE B3-3

- ✓ Wood or metal Purlins are most often used in applications where Trusses are spaced greater than 4' o.c. The Purlins must be properly sized and fastened to the Top Chord of the Trusses in accordance with the specifications found in the Construction Documents. The Trusses must be designed so that the maximum allowable unbraced length for the Top Chord is greater than or equal to the on-center spacing of the Purlins.



Note: Example of Lateral Restraint and Diagonal Bracing installed in the Top Chord Plane.

FIGURE B3-4

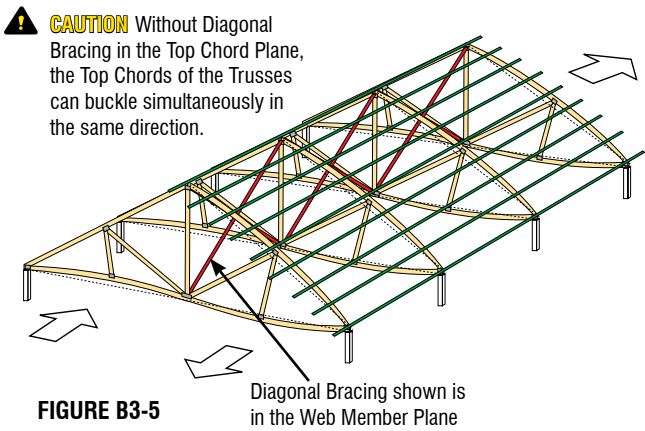


FIGURE B3-5

Note: The Purlins alone will not adequately brace or prevent buckling of the Top Chord and must themselves be braced. This bracing can be provided in a number of ways including:

- Installing Diagonal Bracing to the Top Chord Plane at intervals along the length of the Building to provide rigidity and to transfer the restraining forces from the Purlins to a lateral force resisting system (e.g., braced wall panels, shearwalls, braced frames, etc.),
- Attaching Structural Sheathing directly to the Purlins

**NOTICE** Not all sheathing products are structural. The Building Designer is responsible for the design and detailing of the Structural Sheathing and Diaphragms.

**CAUTION** Without some form of Permanent Diagonal Bracing, the Purlins by themselves only ensure that the Top Chords of the Trusses will all buckle in the same direction.

- ✓ The Building Designer is responsible for the design and detailing of the Purlins and the PBSB for the roof system.
- ✓ The TDD provides information on the assumed support for the Top Chord based on the Load conditions for which the Truss has been designed. This typically includes directly applied Structural Sheathing or Purlins at a specified maximum o.c. spacing.

## 2. PERMANENT BRACING FOR THE BOTTOM CHORD PLANE

- ✓ Permanent Bracing for the Bottom Chords of Trusses is typically provided by attaching either gypsum board panels or Continuous lumber Lateral Restraint properly braced against lateral movement.

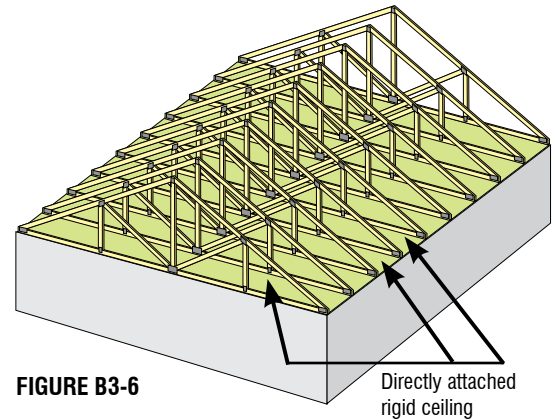
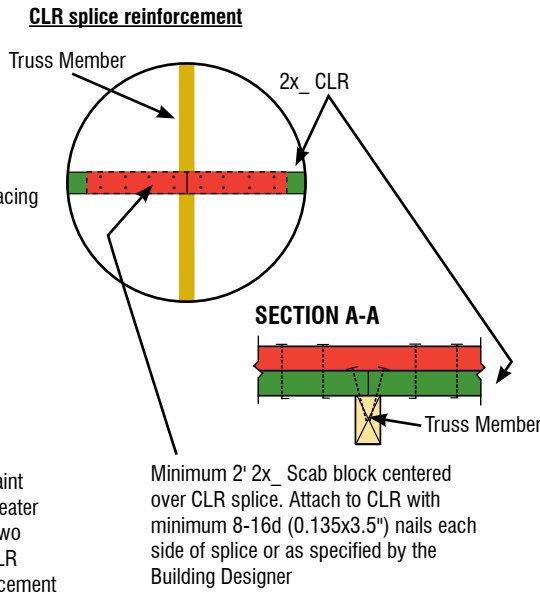
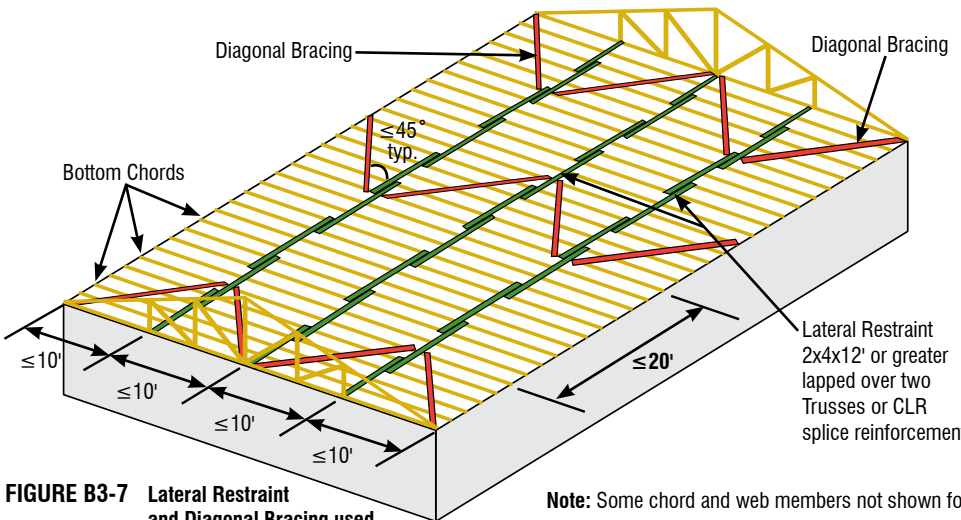


FIGURE B3-6

- ✓ Lumber used as Lateral Restraint and/or Diagonal Bracing shall be stress rated.
- ✓ Bottom Chord Permanent Lateral Restraint shall be installed at the spacing indicated on the TDD and/or by the Building Designer with a maximum of 10' on-center.
- ✓ The TDD provides information on the assumed support for the Bottom Chord based on the Load conditions for which the Truss has been designed. This typically includes a directly applied rigid ceiling or rows of Lateral Restraint at a specified maximum on-center spacing.

# BCSI-B3: Permanent Restraint/Bracing of Chords & Web Members

- Install rows of Diagonal Bracing at intervals of no more than 20' along the length of the Building, or as specified by the Building Designer, to provide stability and transfer the forces from the Lateral Restraint to a lateral force resisting system.



**FIGURE B3-7** Lateral Restraint and Diagonal Bracing used to brace the Bottom Chord Plane.

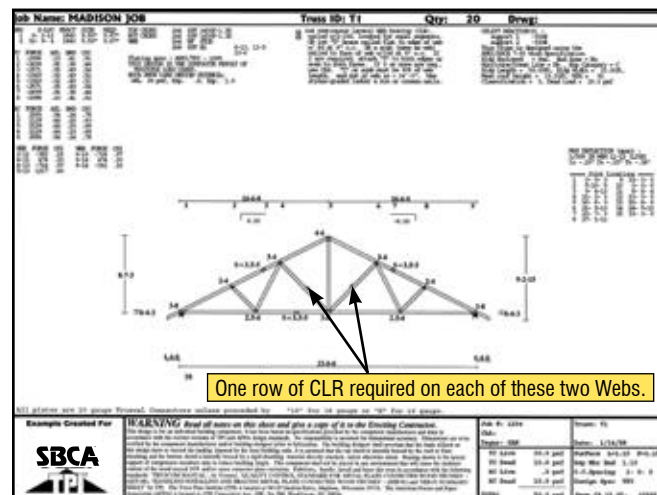
Note: Some chord and web members not shown for clarity.

### 3. PERMANENT BRACING FOR THE WEB MEMBER PLANE

- Permanent Bracing is typically installed in the Web Member Plane of a Truss to collect and transfer forces produced by the restraint of members subject to buckling and/or to transfer lateral Loads from wind and Seismic Forces applied to the Truss System. The same Bracing can often be used to support both functions. This Bracing is referred to as Permanent Stability Bracing and is the responsibility of the Building Designer.

#### Individual Web Member Permanent Restraint & Diagonal Bracing

- Certain web members require restraint and Diagonal Bracing to prevent out-of-plane buckling when subjected to anticipated design forces.



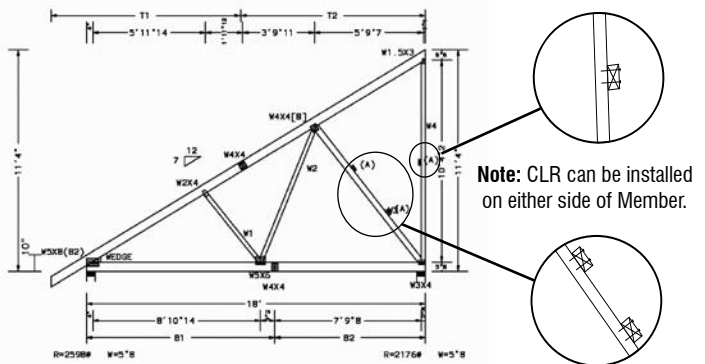
**FIGURE B3-8**

- Web member restraint is typically accomplished by either reducing the unsupported length of the web member via Lateral Restraint or by reinforcing the member with additional material and thus increasing its cross-section.
- The TDD indicates which web members (if any) require this restraint.

#### Diagonal Bracing & Continuous Lateral Restraint

- If individual Web member permanent Lateral Restraint is required on a particular Truss design, Continuous Lateral Restraint (CLR), consisting of 2x4 stress-graded dimension lumber attached at right angles to the Web in combination with Diagonal Bracing, is most frequently specified.
- Webs may require one or two rows of CLR.
- The TDD will specify the number of rows and approximate location of the CLR.

**NOTICE** The CLR can be installed on either side of the member.



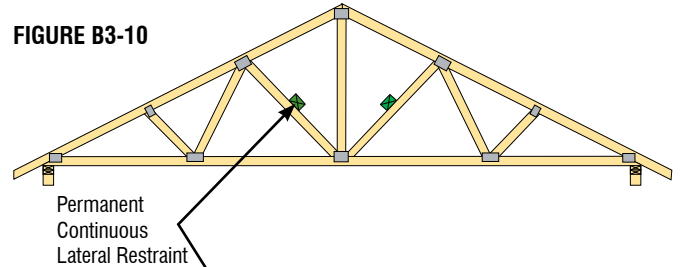
**FIGURE B3-9**

## BCSI-B3: Permanent Restraint/Bracing of Chords & Web Members

**Important Note:** CLRs shall always be Diagonally Braced for rigidity.

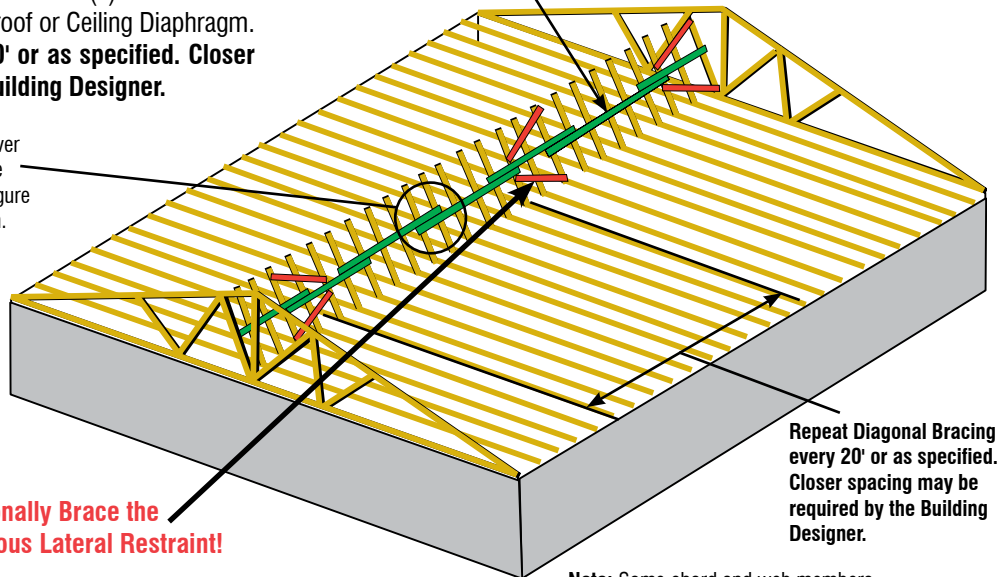
- ✓ Diagonal Bracing with CLRs work most efficiently when applied to three or more similar Trusses.
- ✓ Attach the Lateral Restraint at the locations shown on the TDD together with a Diagonal Brace at an angle of less than or equal to  $45^\circ$  to the Lateral Restraint (see Figures B3-12 and 13). Position the Diagonal Brace so that it crosses the web in close proximity to the Lateral Restraint. The Diagonal Bracing should be attached as close to the Top and Bottom Chord Plane as possible and to each web that it crosses. This provides rigidity that prevents the Webs from displacing laterally.
- ✓ Diagonal Bracing is required to restrain the CLR(s) and to transfer the cumulative force from the CLR(s) into a lateral force resisting system such as the roof or Ceiling Diaphragm. **Repeat Diagonal Bracing every 20' or as specified. Closer spacing may be required by the Building Designer.**

FIGURE B3-10



Lateral Restraint lapped over two Trusses or CLR splice reinforcement. Refer to Figure B3-7 for more information.

FIGURE B3-11



**Always Diagonally Brace the Permanent Continuous Lateral Restraint!**

Repeat Diagonal Bracing every 20' or as specified. Closer spacing may be required by the Building Designer.

Note: Some chord and web members not shown for clarity.

### EXAMPLES OF DIAGONAL BRACING WITH ONE ROW OF CONTINUOUS LATERAL RESTRAINT

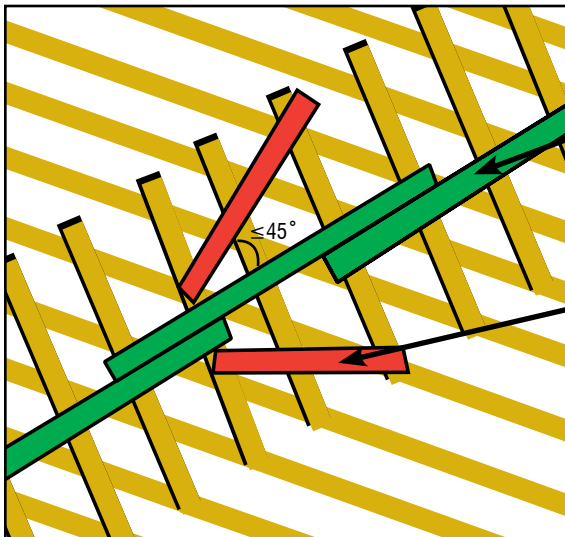


FIGURE B3-12

Continuous Lateral Restraint

Diagonal Bracing

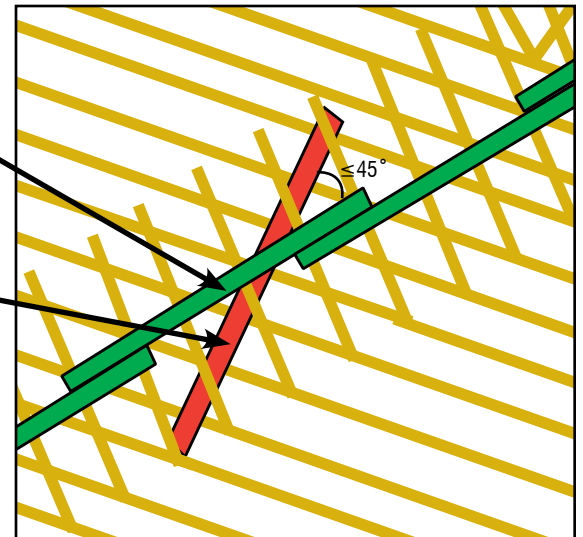


FIGURE B3-13

## BCSI-B3: Permanent Restraint/Bracing of Chords & Web Members

- For webs that require two rows of CLR, the concepts are the same as those used to brace a single row of CLR (see Figure B3-14 and B3-15 for examples). Position the Diagonal Brace(s) to cross the webs in close proximity to each Lateral Restraint to minimize the out-of-plane bending forces in the web. Attach the Diagonal Brace(s) as close as possible to the Top and Bottom Chord Plane and to each web that the Diagonal Brace(s) crosses.

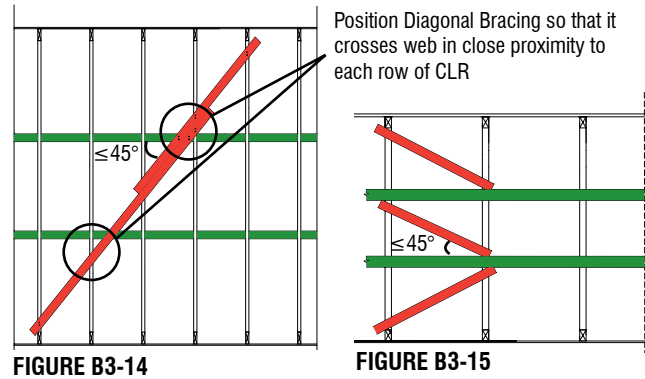


FIGURE B3-14

FIGURE B3-15

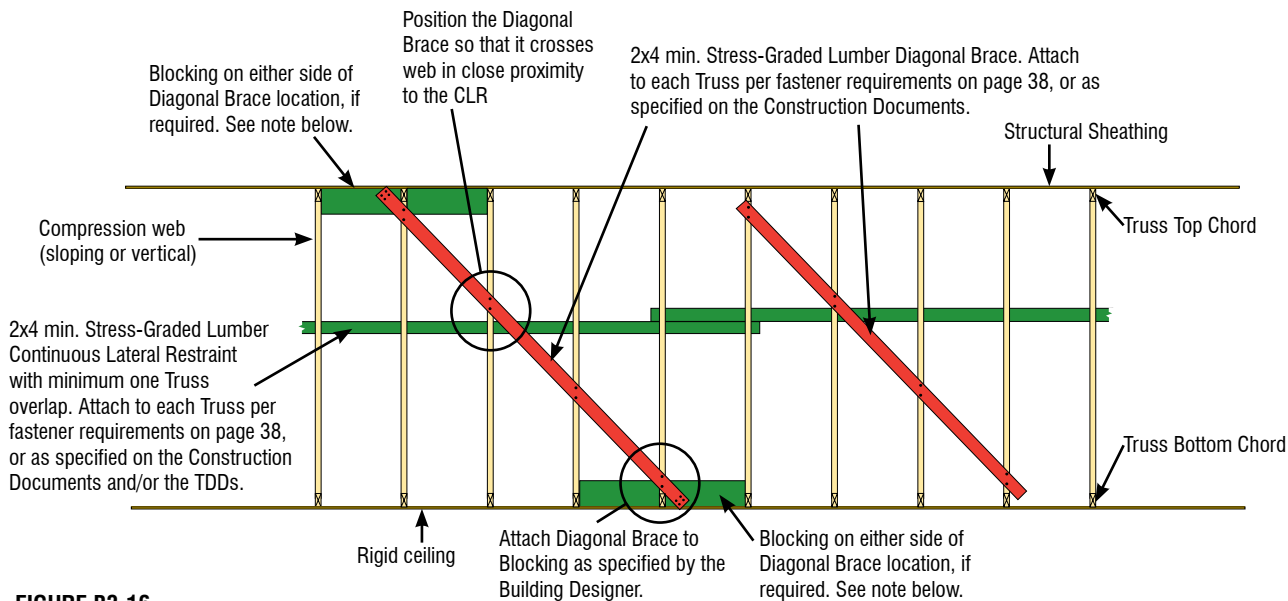


FIGURE B3-16

**Note:** To help transfer large Bracing forces into the roof and ceiling Diaphragms, dimension lumber Blocking may need to be installed between the Trusses on either side of the Diagonal Brace location as shown in Figure B3-16. Cut the Blocking to fit snugly between the Trusses and attach to the Trusses and the Diaphragm. The Blocking helps to transfer the lateral Load directly from the Diagonal Brace into the Diaphragm.

- Diagonal Bracing combined with Lateral Restraint can also be used with small groups of Trusses. Figure B3-17, page 43, provides an example of a Building containing nine Trusses with three different configurations. Each Truss configuration contains web members that require Lateral Restraint, and these web members are in different locations for each configuration. To ensure the webs of these Trusses are properly braced, install Lateral Restraints (shown in green) and Diagonal Bracing (shown in red) within each group of Trusses. Extend the Diagonal Bracing from the Top Chord to the Bottom Chord of the adjacent Trusses. Attach the Diagonal Bracing to the Web of the middle Truss near the location of the CLR and to each intersecting Truss. This provides the rigidity that prevents the Webs and the CLR from displacing laterally.
- If there are only two adjacent Trusses in which the webs align, Diagonal Bracing and Lateral Restraint can still be used. One option is to attach the single Diagonal Brace to each Web

and the Lateral Restraint. This is accomplished by attaching the Diagonal Brace to the opposite side of the web with the Lateral Restraint. Attach the Diagonal Brace near the top of the web of the first Truss and near the bottom of the web of the second Truss. Install dimension lumber blocking, of the same depth as the webs, directly behind the Lateral Restraint and attach the blocking to the Lateral Restraint, Diagonal Brace and each web (see Figure B3-18, page 43). A second option is to install two Diagonal Braces. Attach one end of each Diagonal Brace to the web at the permanent restraint location shown on the TDD and attach the other near the top or bottom of the web of the adjacent Truss (see Figure B3-19, page 43).

- Some Truss Manufacturers will mark the web member(s) that require permanent restraint on the Truss itself. One supplemental marking example is the tag shown in Figure B3-20, page 43.



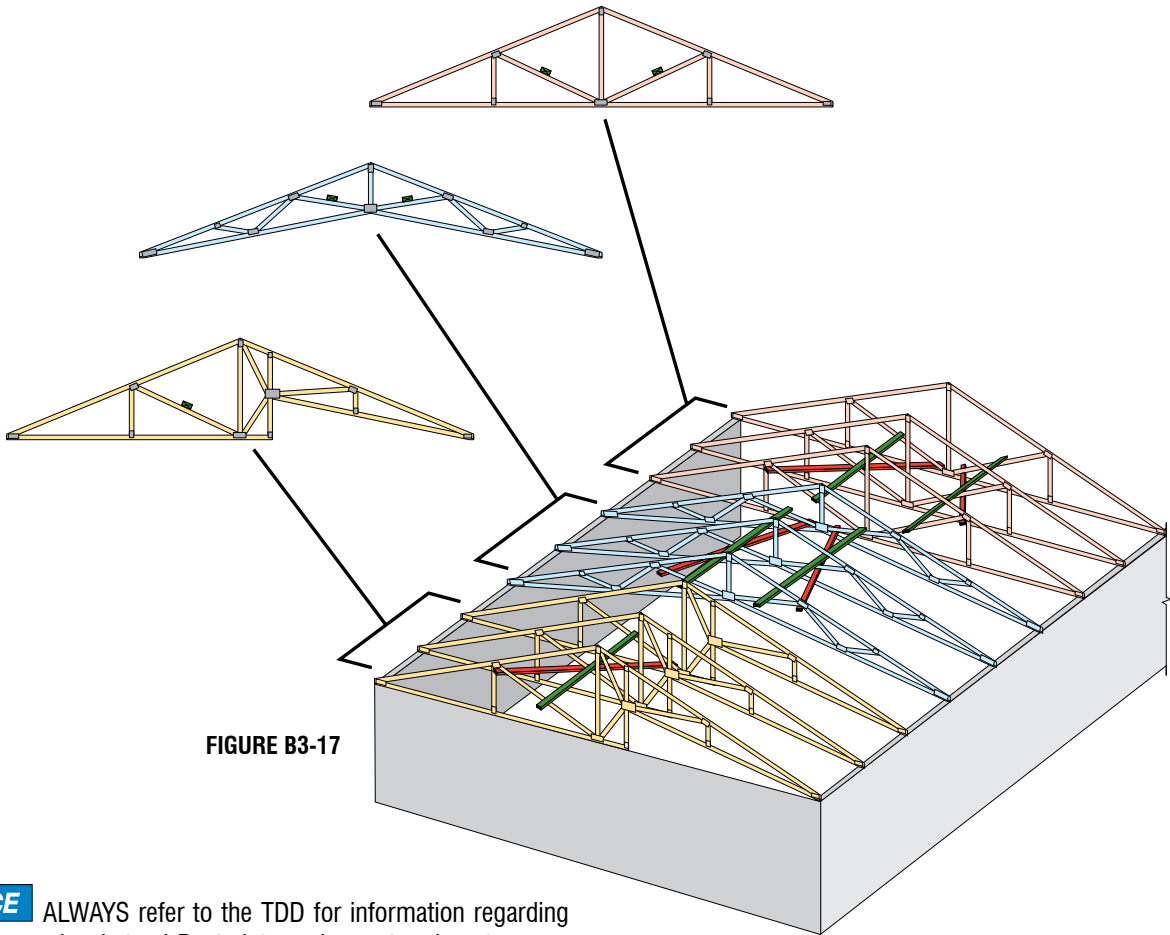


FIGURE B3-17

**NOTICE** ALWAYS refer to the TDD for information regarding web member Lateral Restraint requirements, since tags are not always used and can be mis-located or fall off.

- ✓ Unless otherwise specified, lumber used for Lateral Restraint and Diagonal Bracing shall be at least 2x4 Stress-Graded Lumber. Fasten to each Truss with at least 2-10d (0.128x3"), 2-12d (0.128x3.25"), or 2-16d (0.131x3.5") nails as specified in the Construction Documents and/or on the TDDs.
- ✓ Proprietary Metal Restraint/Bracing Products are also available.

**ALWAYS DIAGONALLY BRACE THE CONTINUOUS LATERAL RESTRAINT!**

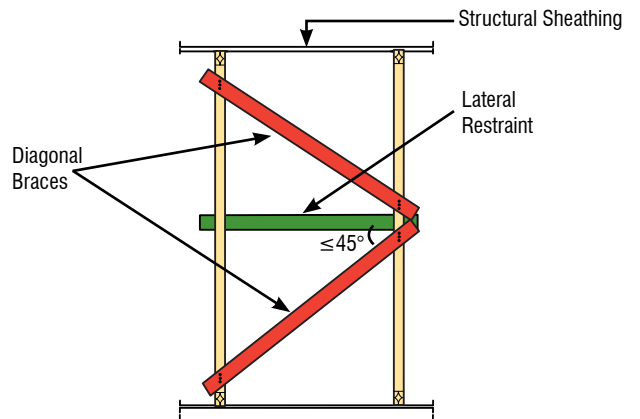


FIGURE B3-19

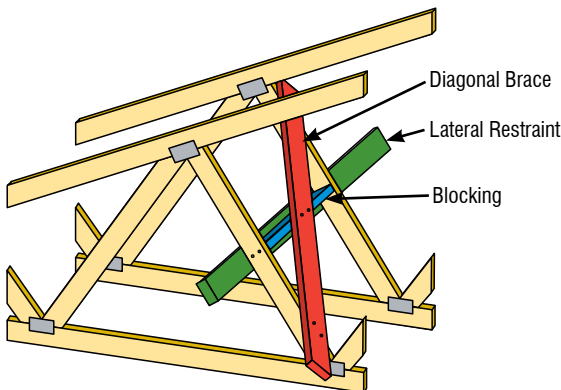


FIGURE B3-18

**PERMANENT LATERAL RESTRAINT & DIAGONAL BRACING REQUIRED**

NOTE: WEB MEMBER REINFORCEMENT MAY ALSO BE POSSIBLE; SEE BCSI-B3

SEE TRUSS DESIGN DRAWING FOR LATERAL RESTRAINT; CONSULT BUILDING DESIGNER AND/OR BCSI-B3 FOR DIAGONAL BRACING

LATERAL RESTRAINT  
DIAGONAL BRACING

VEA EL DIBUJO DE DISEÑO DE TRUSS PARA RESTRICCIÓN LATERAL; CONSULTE AL DISEÑADOR DE EDIFICIO Y/O BCSI-B3 PARA ARRIOSTRE DIAGONAL

**RESTRICCIÓN LATERAL PERMANENTE Y ARRIOSTRE DIAGONAL ES REQUERIDO**

www.igres.org

www.igres.org

PLATE HERE

SBC

www.sbcshiplift.com

Copyright © 2017

PLATE HERE

FIGURE B3-20

## BCSI-B3: Permanent Restraint/Bracing of Chords & Web Members

### Individual Web Reinforcement (Jobsite Applied)

As stated in Section 2303.4.1.2 of the 2012 IBC (see also Chapter 2 of ANSI/TPI 1), one Truss member permanent Bracing option is that “Trusses shall be designed so that the buckling of any individual Truss member is resisted internally by the individual Truss through suitable means (i.e., buckling reinforcement by T-reinforcement or L-reinforcement, proprietary reinforcement, etc.). The buckling reinforcement of individual members of the Trusses shall be installed as shown on the Truss Design Drawing or on supplemental Truss member buckling reinforcement details provided by the Truss Designer.” This individual member buckling reinforcement is installed by the Contractor.

- ✓ T-, L-, Scab, I- or U-Reinforcement are five options that involve adding lumber to increase the web’s section properties, thereby increasing its resistance to buckling. Proprietary metal reinforcement products and stacked web products are also viable alternatives. This type of reinforcement is typically used as an alternative to the combination of Continuous Lateral Restraint (CLR) and Diagonal Bracing when CLR is not possible or desirable.
- ✓ T-Reinforcement is commonly used and creates a “T” shape when applied to the web member.

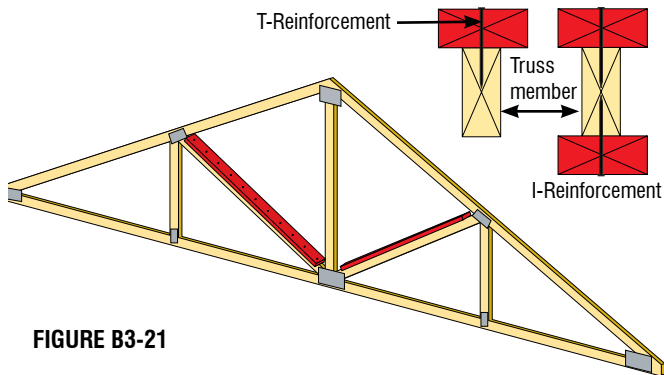


FIGURE B3-21

- ✓ L-Reinforcement is similar to T-Reinforcement, but creates a flat surface on one face of the Truss to permit the direct application of sheathing material.

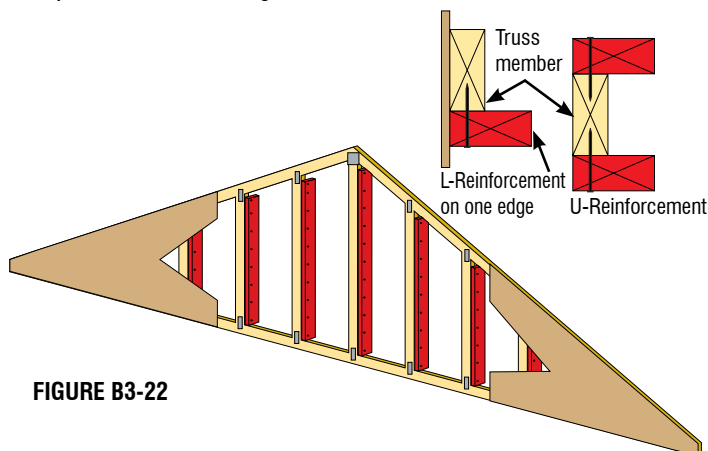


FIGURE B3-22

- ✓ Scab Reinforcement is installed on one face of the Web. It is often more structurally efficient for multiple-ply Webs and provides easier nailing because it is applied to a wide-face of the Web.

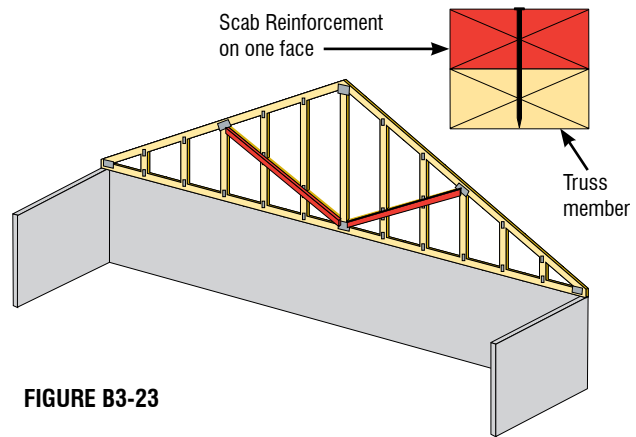


FIGURE B3-23

- ✓ I- and U-Reinforcement are similar to T- and L-Reinforcement, respectively, except that two (2) pieces of lumber are added, one to each narrow face of the Web. Refer to Figure B3-21 and B3-22, respectively, for examples of I- and U-Reinforcement..
- ✓ The size, grade and species of the Web Reinforcement material, as well as the nailing schedule for attaching the reinforcement to the Web, is typically specified on the Truss Design Drawing, or a supplemental document provided by the Truss Designer. It is sometimes also specified in the Construction Documents prepared by the Building Designer.
- ✓ Table B3-2, page 45, provides generic reinforcement information that can be used in the event that information from the Truss Designer is not available. The reinforcement information in this table is limited to the reinforcement of Webs in single-ply Trusses in which there is either one or two rows of CLR specified on the TDD. This information is conservative, and a more efficient means of reinforcement may be available from the Truss Designer.
- ✓ Some Truss Manufacturers provide additional assistance by marking the web members that require permanent reinforcement. An example of one such supplemental marking is the Truss tag shown in Figure B3-24.

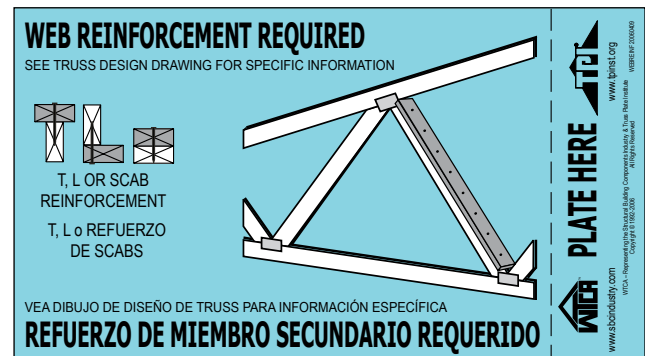


FIGURE B3-24

WEB REINFORCEMENT FOR SINGLE-PLY TRUSSES <sup>1</sup>								
Specified CLR	Size of Truss Web	Type & Size of Web Reinforcement				Grade of Web Reinforcement	Minimum Length of Web Reinforcement	Minimum Connection of Web Reinforcement to Web
		T	L	Scab <sup>2</sup>	I			
1 Row	2x4	2x4	2x4	2x4		Same species and grade or better than web member	90% of Web or extend to within 6" of end of web member, whichever is greater	16d (0.131x3.5") nails @ 6" on-center <sup>2</sup>
	2x6	2x6	2x6	2x6				
	2x8	2x8	2x8	2x8				
2 Rows	2x4	---	---	---	2-2x4			
	2x6	---	---	---	2-2x6			
	2x8	---	---	---	2-2x8			

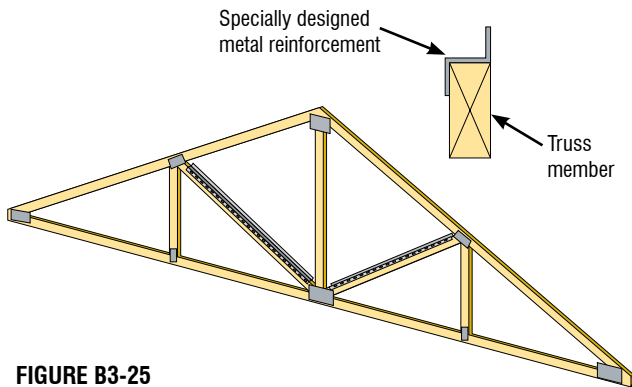
<sup>1</sup>Maximum web length is 14'.

<sup>2</sup>Attach Scab Reinforcement to web with two rows of minimum 10d (0.120x3") nails at 6" on-center.

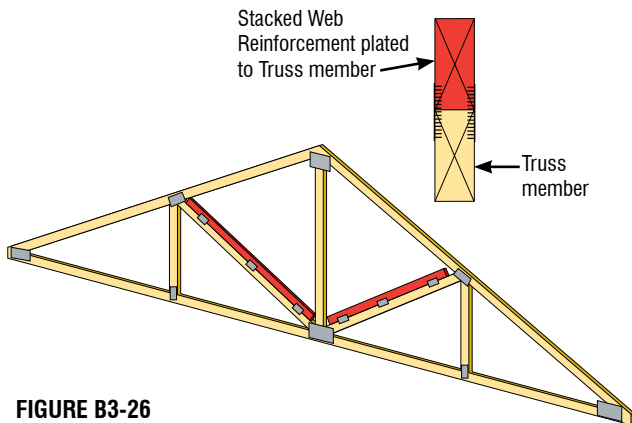
**TABLE B3-2**

*Individual Web Reinforcement (Shop Applied)*

- ✓ Proprietary metal reinforcement products and Stacked Web Reinforcement are installed by the Truss Manufacturer at the Truss plant and eliminate the need for additional jobsite reinforcement of the Webs.



**FIGURE B3-25**

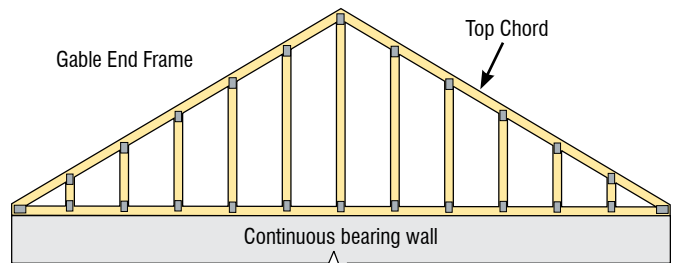


**FIGURE B3-26**

- ✓ Permanent Building Stability Bracing for wind, seismic and/or other lateral Loads acting perpendicular to the plane of the Trusses will always be needed in every Building.

**Gable End Frame Permanent Bracing**

- ✓ Permanent Bracing in the Web Member Plane, installed at each end of the Building, serves to transfer lateral Loads acting against the end walls and gable ends of the Building into the roof and/or ceiling Diaphragm. The Building Designer is responsible for the design of this Permanent Building Stability Bracing.
- ✓ Metal plate connected Gable End Frames are often used directly above the end walls of a Building to save the Contractor the time and expense of having to field frame the end wall to match the roof slope.
- ✓ Most manufactured Gable End Frames contain only vertical "studs" (as opposed to the typical triangulated web members) and are designed to transfer only vertical roof Loads (gravity and/or uplift) directly into a continuous bearing below. Web member reinforcement shown on the TDD for these frames is required to prevent column buckling of the web members due to the vertical Loads applied to the Truss.



**FIGURE B3-27**

## BCSI-B3: Permanent Restraint/Bracing of Chords & Web Members

- ✓ In service, Gable End Frames also experience lateral Loads parallel and perpendicular to their plane. The Gable End Frame shall be incorporated into the wall design by the Building Designer.

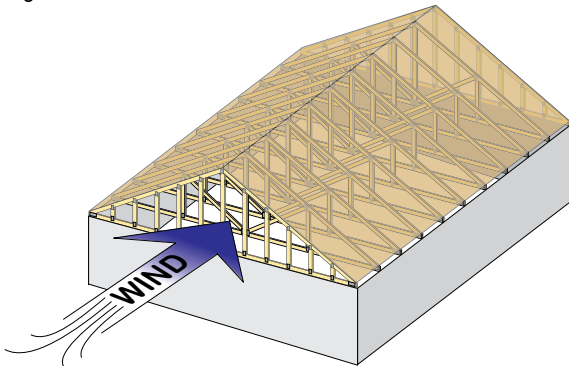


FIGURE B3-28

- ✓ Gable End Frames rely on properly designed and installed Structural Sheathing, Bracing and Connections to the bearing wall, and roof and Ceiling Diaphragms to be able to adequately transfer lateral Loads acting parallel and perpendicular to its plane.
- ✓ The Building Designer, Truss Designer and Contractor all play a vital role in Gable End Frame bracing.

### *Building Designer Responsibilities for Gable End Frame Bracing*

- ✓ The Building Designer, knowing the intended flow of Loads for the entire Building, is responsible for taking the resultant Loads that exist within the Gable End Frame and safely transferring these Loads into the ground. This typically involves transferring the Loads through additional Bracing from the Gable End Frame to the roof and Ceiling Diaphragms.
- ✓ Gable End Frame Bracing is designed by considering a number of factors including:

- The length, spacing, species and size of the Gable End Frame studs
- Gravity Loads
- Lateral Loads (wind and seismic)

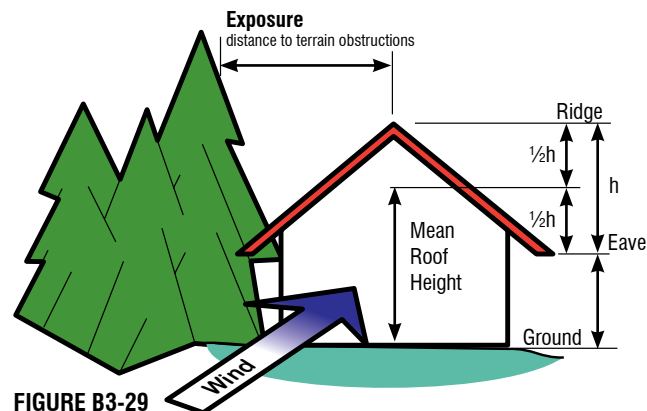


FIGURE B3-29

- ✓ The Building Designer, through detailing in the Construction Documents, is responsible for all Gable End Frame Bracing, including the Bracing member size and locations, attachment to Trusses, gable end sheathing, and fastener size and locations including any mechanical Connectors required.

- ✓ Other factors the Building Designer shall consider include:

- Thickness and type of roof, wall and ceiling sheathing
- Transfer of Load between the Gable End Frame Bottom Chord and wall below
- Attachment of Structural Sheathing to the wall/Gable End Frame interface and attachment of wall to foundation to resist uplift and lateral Loads

### *Truss Designer Responsibilities for Gable End Frame Reinforcement*

- ✓ The Truss Designer must note on the TDD for the Gable End Frame the type and location of Permanent Individual Truss Member Restraint (PITMR) required to resist the vertical Loads assumed in the design of the frame. Examples include single or double L, T, U, Scab, horizontal L or any other means of reinforcement deemed appropriate to restrain the out-of-plane buckling of the vertical “studs.”
- ✓ The Truss Designer is responsible for indicating the loading and environmental design assumptions used in the design of the Gable End Frame to conform to the Loads specified in the Construction Documents.
- ✓ In order to assist the Building Designer in determining the Bracing required to transfer lateral Loads from the Gable End Frame into the roof and/or Ceiling Diaphragm, many Truss Designers provide standard design tables and details based on the typical design assumptions used by Building Designers.

Minimum Stud Size Species and Grade	Stud Spacing	Without Brace	1x4 L-Brace	2x4 L-Brace	DIAGONAL BRACE	2 DIAGONAL BRACES AT 1/3 POINTS
Maximum Stud Length						
2x4 SPF Stud	12" O.C.	4-9-12	5-6-7	7-10-0	9-7-7	14-5-3
2x4 SPF Stud	16" O.C.	4-4-7	4-9-8	6-9-8	8-8-14	13-1-5
2x4 SPF Stud	24" O.C.	3-9-10	3-11-0	5-6-7	7-7-4	11-4-14

+ Diagonal braces over 6'-3" require a 2x4 T-Brace attached to one edge. Diagonal braces over 12'-0" require 2x4 L-braces attached to both edges. Fasten T and I braces to narrow edge of web with 10d common wire nails 8in o.c., with 3in minimum end distance. Brace must cover 90% of diagonal length.

MAXIMUM WIND SPEED = 100 MPH  
 MAX MEAN ROOF HEIGHT = 30 FEET  
 CATEGORY II BUILDING  
 EXPOSURE B or C  
 ASCE 7-98  
 DURATION OF LOAD INCREASE = 1.60

STUD DESIGN IS BASED ON COMPONENTS AND CLADDING CONNECTION OF BRACING IS BASED ON MWFRS.

FIGURE B3-30

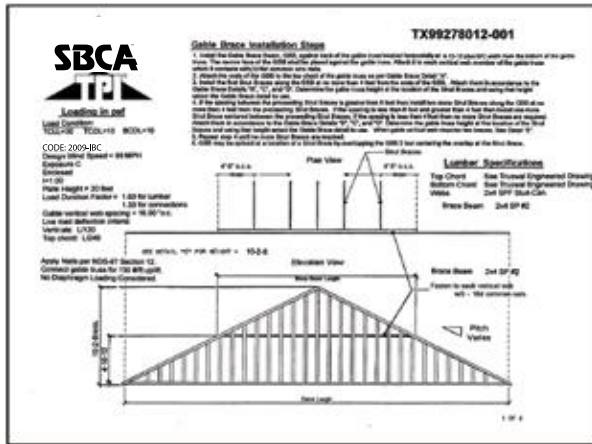


FIGURE B3-31

- ✓ These tables and details do some of the work of the Building Designer with respect to incorporating the Gable End Frame into the overall structural design, but do not take the place of a complete flow of Loads analysis by the Building Designer.

*Contractor Responsibilities for Gable End Frame Bracing*

- ✓ The Contractor is responsible for properly installing the Gable End Frame as detailed in the Construction Documents and within the Truss Submittal Package.

*Gable End Frame Bracing/Reinforcement Requirements*

- ✓ If the lateral Load is large enough, and the vertical studs are long enough, the Gable End Frame may require Bracing to prevent it from rotating at the Gable End Frame/end wall interface, along with Diagonal Bracing and/or Web Reinforcement to prevent the vertical Webs from bending excessively. Serviceability failures often occur if the Gable End Frame is not properly braced.
- ✓ Gable End Frame Bracing/reinforcement helps prevent these types of serviceability failures and safely transfers forces from the Gable End Frame into the associated Diaphragms.

**Lateral Force transfer to roof and Ceiling Diaphragms**

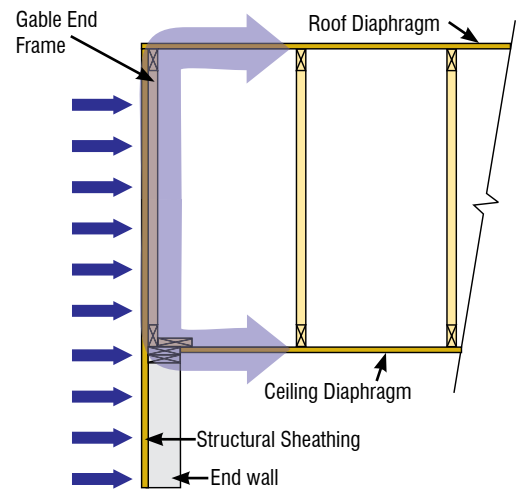


FIGURE B3-32

**Potential Modes of Failure**

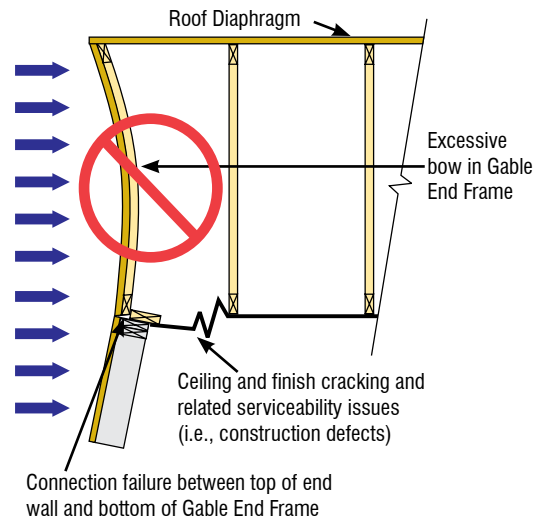
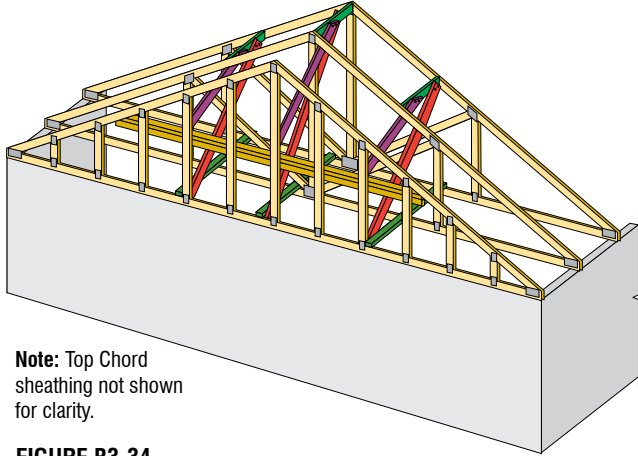


FIGURE B3-33

- ✓ Typical Gable End Frame Bracing/reinforcement details include Blocking at the ceiling and roof level Diaphragms, gable stud reinforcement, horizontal reinforcement and/or Diagonal Bracing, mechanical Connectors/straps and specific fastener size and frequency schedules.

## BCSI-B3: Permanent Restraint/Bracing of Chords & Web Members

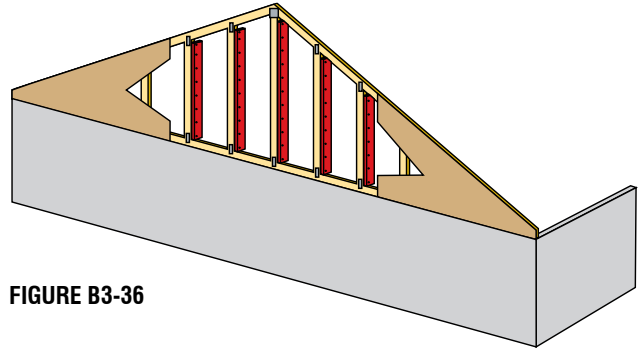
✓ Examples of Gable End Frame Bracing/reinforcement.



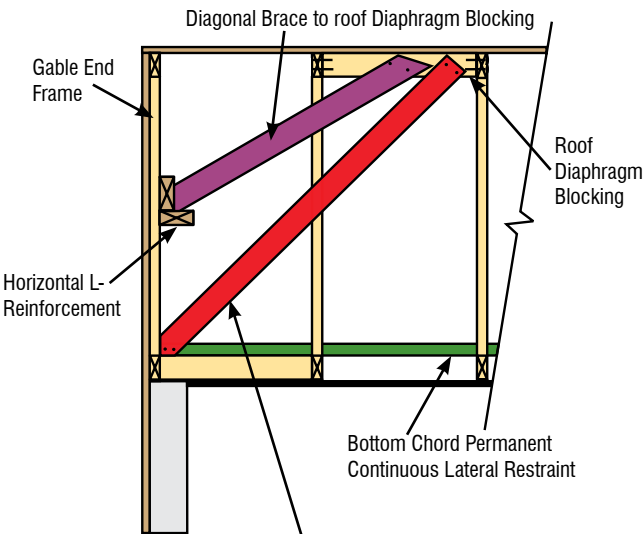
**Note:** Top Chord sheathing not shown for clarity.

**FIGURE B3-34**

✓ Examples of Gable End Frame Web Reinforcement.



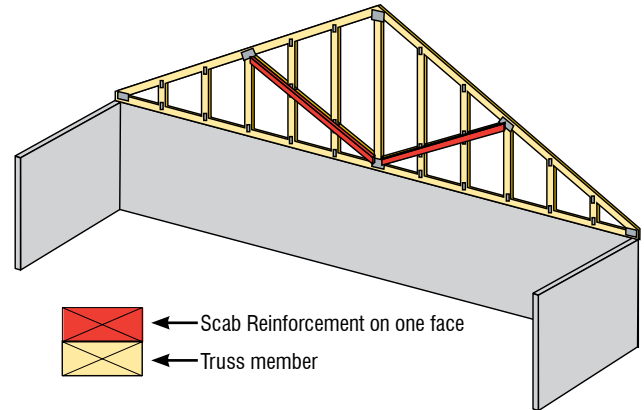
**FIGURE B3-36**



Gable end wall permanent Diagonal Bracing. Locate in line with Bottom Chord permanent CLR or as specified in the Construction Documents (see Figure B3-40, page 50).

**FIGURE B3-35**

**Note:** The Diagonal Brace from the top of the end wall to the top chord of the Truss will impart a vertical force to the Truss Top Chord. This is in addition to any uplift forces the roof sheathing will impart to the Truss from wind. The Load from this brace must be considered in the design and attachment of the supporting Truss.



**FIGURE B3-37**

# BCSI-B3: Permanent Restraint/Bracing of Chords & Web Members

- Sample detail of Gable End Frame Bracing and Reinforcement (as provided by the Building Designer).

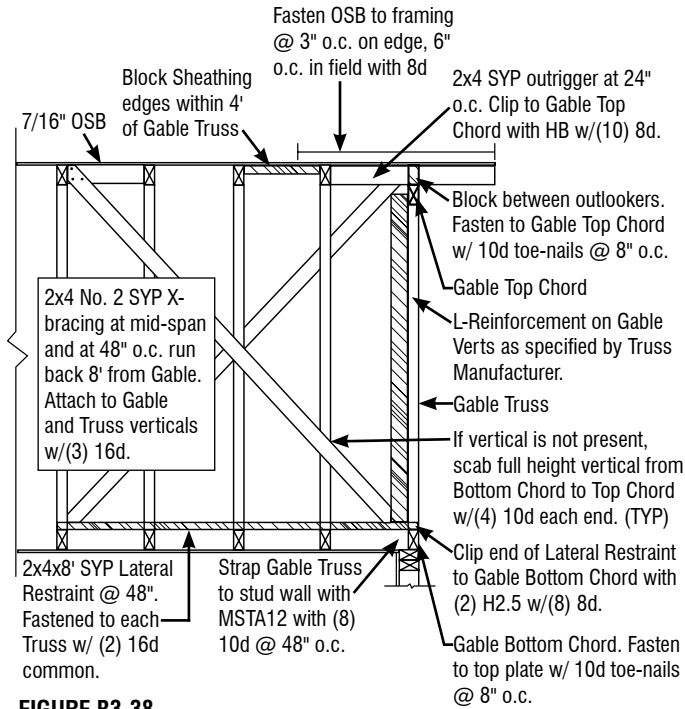


FIGURE B3-38

- Sample "Standard Gable End Frame Detail" (as provided by the Truss Designer)

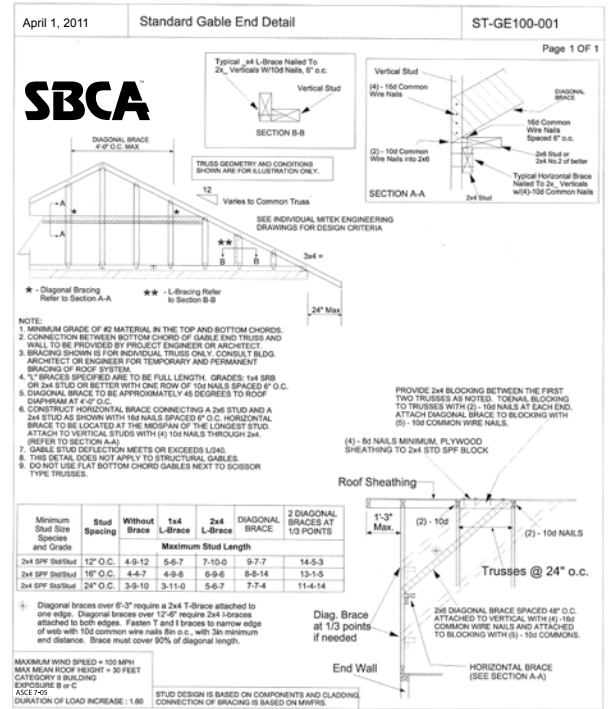
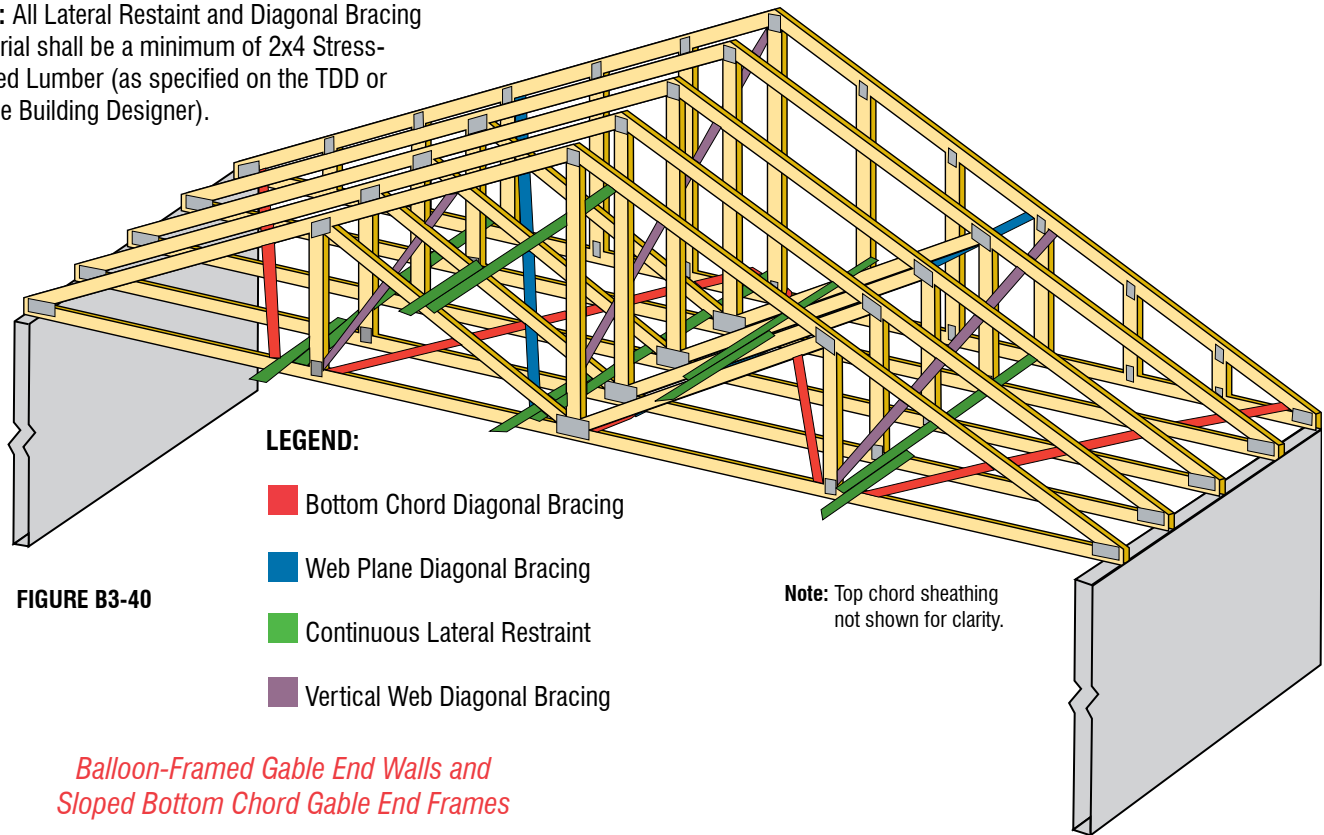


FIGURE B3-39

## BCSI-B3: Permanent Restraint/Bracing of Chords & Web Members

- ✓ Sample detail of permanent restraint/Bracing near end of Building.

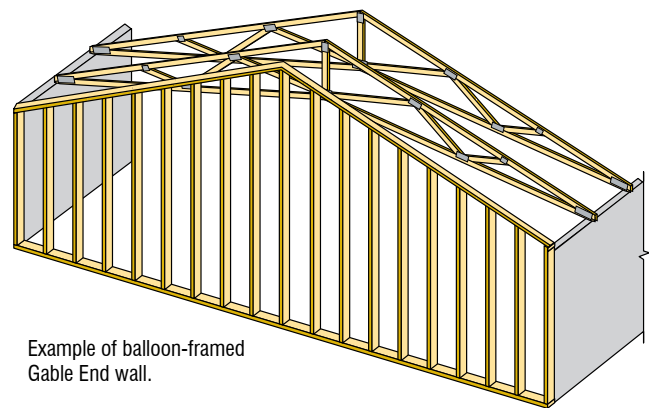
**Note:** All Lateral Restraint and Diagonal Bracing material shall be a minimum of 2x4 Stress-graded Lumber (as specified on the TDD or by the Building Designer).



**FIGURE B3-40**

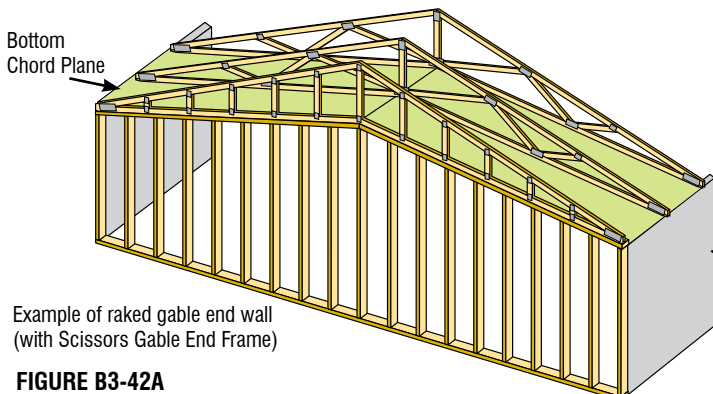
### *Balloon-Framed Gable End Walls and Sloped Bottom Chord Gable End Frames*

- ✓ The Building Designer may decide to design a balloon-framed end wall, which eliminates the need for a Gable End Frame (see Figure B3-41). If a Gable End Frame is used, it must match the profile of the adjacent Trusses so that proper Bottom Chord Plane Bracing can be installed (see Figure B3-42A), unless special Bracing is designed to support the end wall.

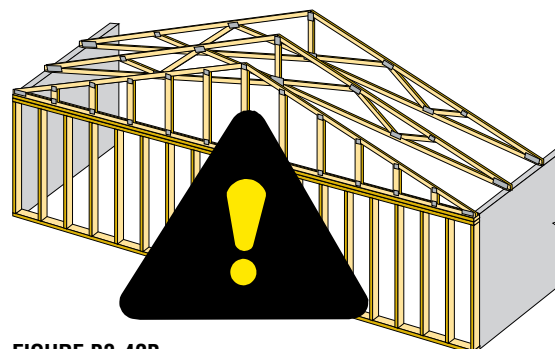


**FIGURE B3-41**

- ⚠ **CAUTION** A flat Bottom Chord Gable End Frame used with adjacent Trusses that have sloped Bottom Chords (see Figure B3-42B) creates a hinge in the wall/gable interface that is below the Bottom Chord Plane Diaphragm. This condition is prohibited by some Building codes because adequate Bracing of this condition is difficult and sometimes impossible. Special end wall Bracing design considerations are required by the Building Designer if the Gable End Frame profile does not match the adjacent Trusses.



**FIGURE B3-42A**



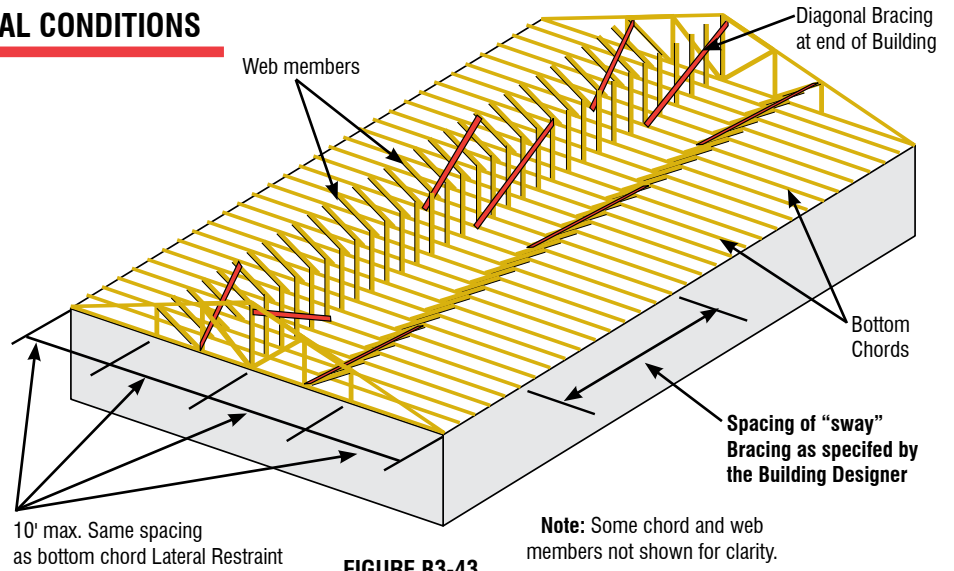
**FIGURE B3-42B**



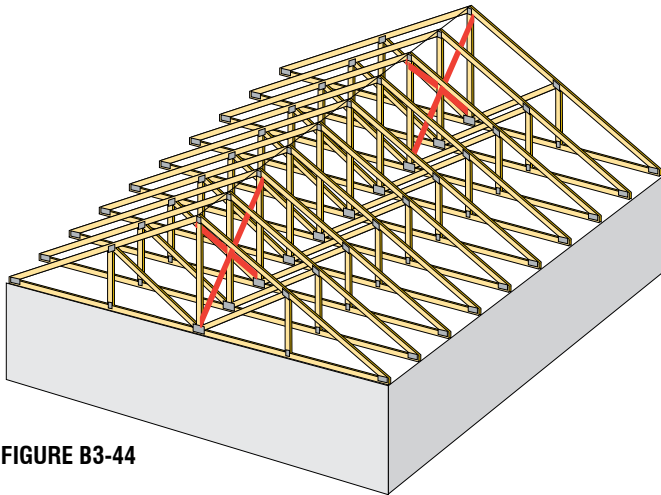
**PERMANENT BRACING FOR SPECIAL CONDITIONS**

**Sway Bracing**

- ✔ Diagonal Bracing, installed at both ends of a Building and repeated along the length of the Building at intervals specified by the Building Designer, helps to stabilize the Truss System and minimize the lateral movement due to lateral Loads. Also referred to as “sway” Bracing, this Bracing serves to stiffen the Truss System, thereby greatly reducing stresses caused by movement or displacement of the Trusses.

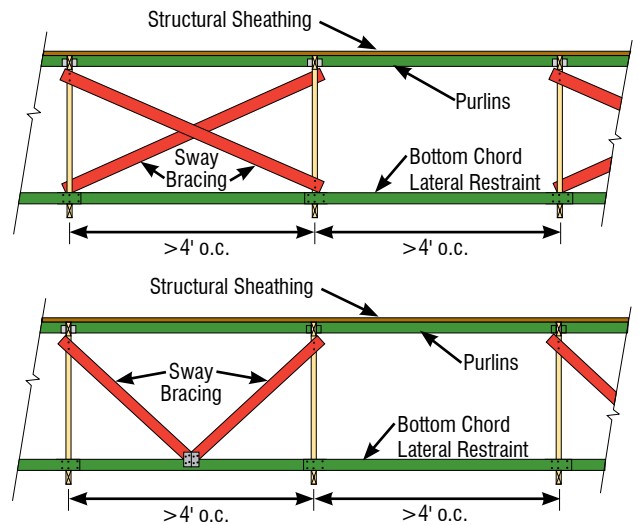


**FIGURE B3-43**



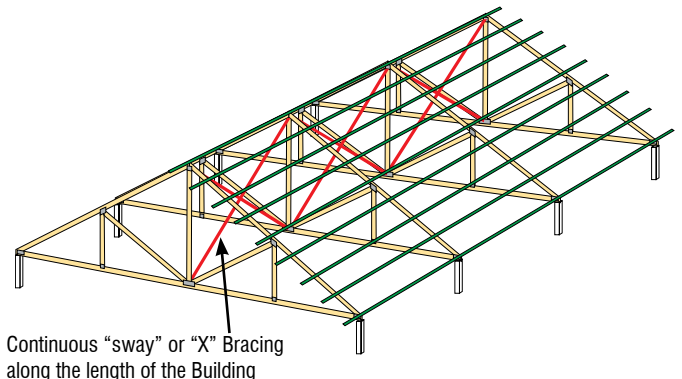
**FIGURE B3-44**

- ✔ Sway bracing is typically installed on web members (verticals whenever possible) located at or near each row of Bottom Chord Lateral Restraint and should extend from the Top Chord Plane to the Bottom Chord Plane at right angles to the Trusses.
- ✔ Sway Bracing is designed and installed at the discretion of the Building Designer and is not always required.
- ✔ Sway Bracing, if continuous, also serves to distribute gravity Loads between Trusses of varying stiffness.



**Note:** Reinforce Lateral Restraints and Bracing, as required, for Truss Spacings greater than 4' o.c.

**FIGURE B3-45**



Continuous “sway” or “X” Bracing along the length of the Building

**FIGURE B3-46**

### PERMANENT BRACING FOR THE TOP CHORD IN A PIGGYBACK ASSEMBLY

- ✓ Long span or steeply pitched Trusses are often too large to be manufactured, shipped and erected in one piece. In these situations, the Trusses are manufactured in two or more “pieces” and assembled at the jobsite. A “Piggyback” Truss assembly is an example of a multi-piece Truss in which a supporting (carrying) Truss is topped with a smaller, supported (cap) Truss carried directly on top of the supporting Truss.
- ✓ A critical consideration with a Piggyback assembly is to make sure that the portion of the Top Chord of the supporting Truss located directly beneath the cap Truss is adequately braced to prevent it from buckling out from under the supported Truss. Bracing for this portion of the Top Chord is accomplished in several ways including:
  - Rows of 4x2 Stress-Graded Lumber CLR and Diagonal Bracing (see Figure B3-47)
  - Connecting the CLR into the roof Diaphragm
  - Adding Structural Sheathing or using Bracing frames (see Figure B3-48)
  - Some other equivalent means
- ✓ The combination of Diagonal Bracing and CLR as a means of Bracing the Top Chord of the supporting Truss is fairly common, especially for conditions where the axial forces in the Top Chord are fairly small and the length of the flat portion of the chord is relatively short.
- ✓ Multiple rows of CLR are typically required and installed across the length of the flat portion of the Top Chord of the supporting Truss.

**NOTICE** If Diagonal Bracing is used to restrain the CLR(s) and to transfer the cumulative force from the CLR(s) into the roof Diaphragm, **repeat the Diagonal Bracing at 10' intervals or as specified. Closer spacing may be required by the Building Designer.**

- ✓ If a Structural Sheathing is used to brace the flat portion of the Top Chords, openings must be provided to permit ventilation between the upper and lower portions of the Piggyback assembly.
- ✓ The TDD provides the maximum assumed spacing for attaching the Lateral Restraint or sheathing to the Top Chord based on the Load conditions for which the Truss has been designed. The TDD also provides the assumed thickness of the restraint and the minimum Connection requirements between the cap and the supporting Truss or restraint.

**NOTICE** The Truss Designer and Truss Manufacturer shall be notified prior to manufacturing the Trusses if the spacing and thickness of the restraint and Bracing between the supported and supporting Trusses will be different than what is shown on the TDD.

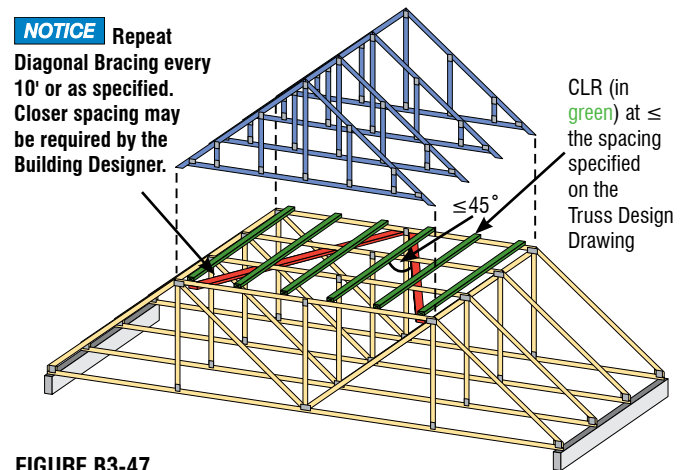


FIGURE B3-47

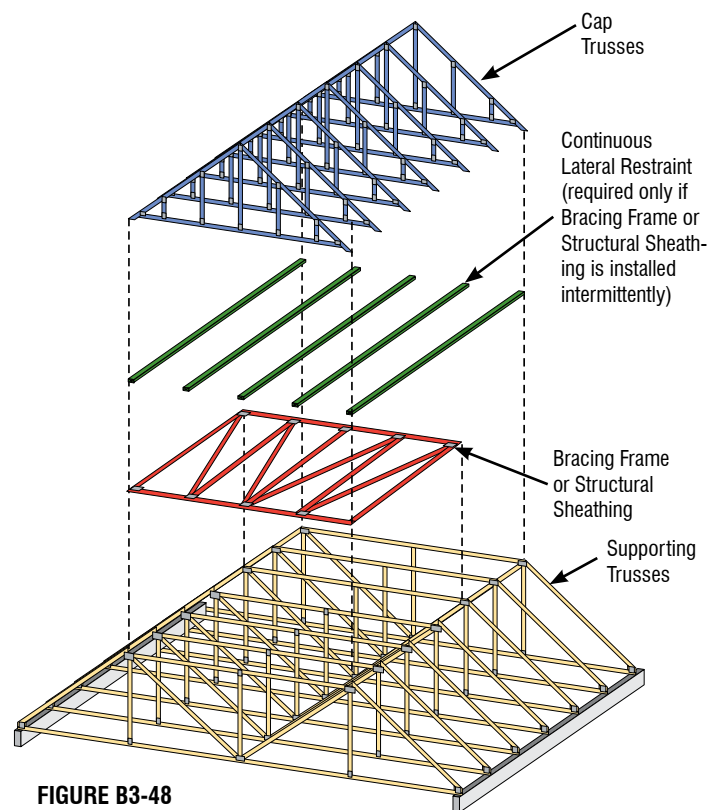


FIGURE B3-48

- ✓ The supporting Trusses shall have all of the required Temporary Bracing discussed in BCSI-B2 and Top Chord Permanent Bracing discussed here installed BEFORE installing the cap Trusses.

**Note:** There are a variety of options for using a Bracing frame to laterally restrain and brace the flat portion of the Top Chord of the supporting Trusses in a Piggyback assembly. Visit the SBCA website at [sbcindustry.com](http://sbcindustry.com) for details and ideas.

## CONSTRUCTION LOADING

The term “construction loading” is typically used to describe Loads from workers and Building materials on an unfinished structure; for example, when builders temporarily stack bundles of panel sheathing or gypsum board on installed Trusses during the construction process.

- ✓ Make sure that the Truss assembly is properly restrained and braced according to the guidelines in **BCSI-B1** and **BCSI-B2**.
- ✓ Construction Loads shall be placed only on fully restrained and braced structures.

**WARNING** Trusses by themselves are very unstable and have **NO CAPACITY** to carry Load until they are properly restrained and braced. Placing Loads on Trusses that have not been properly restrained and braced is hazardous and prohibited. Property damage, personal injury and/or death are possible if this warning is not heeded.

- ✓ Use extreme caution when placing Construction Loads and only stack reasonable amounts of materials (see Table B4-1).

**CAUTION** Stacking excessive amounts of construction materials on floor or roof Trusses is an unsafe practice.

**NOTICE** Trusses that have been over-stressed due to excessive Construction Loading will usually show excessive sagging (deflection) and at least a portion of this deflection will remain even after the Load has been removed. In more severe cases, broken Truss members and/or failed Truss joints may result.

### CONSTRUCTION LOADING DO'S AND DON'TS

- ⊘ **DON'T** stack materials on unbraced Trusses.

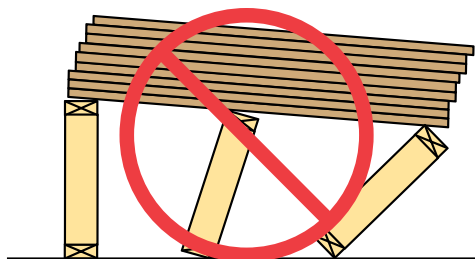


FIGURE B4-1

- ✓ **DO** stack a reasonable amount of material that will not overload the Trusses. (**Note:** Trusses must be properly restrained and braced first).

Maximum Stack Height for Material on Trusses <sup>1,2</sup>	
Material	Height
Gypsum Board	12"
Plywood or OSB	16"
Asphalt Shingles	2 bundles
Concrete Block	8"
Clay Tile	3-4 tiles high

TABLE B4-1

1. This table is based on Trusses designed with a live Load of 40 psf or greater. For other loading conditions, contact a Registered Design Professional.
2. Limit stacking periods to approximately one week unless alternative information is provided by the Building Designer, Truss Designer or Truss Manufacturer.

**Note:** Heavy roofing tile such as clay or stone slate is often “dry-stacked” on the roof for a period of time to allow the roof/ceiling assembly time to “settle” before the finished ceiling is installed. Limit stack heights to those provided in Table B4-1 and stacking periods to approximately one week, unless alternative information is provided by the Building Designer, Truss Designer or Truss Manufacturer.

- ⊘ **DON'T** exceed stack heights listed in Table B4-1 unless alternative information is provided by the Building Designer, Truss Designer or Truss Manufacturer.

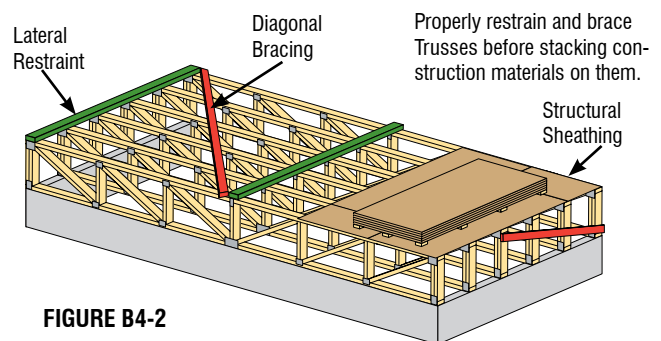


FIGURE B4-2

- ⊘ **DON'T** allow the stack to lean against walls.

- ⊘ **DON'T** stack materials in concentrated areas so that they overload a single or small group of Trusses.

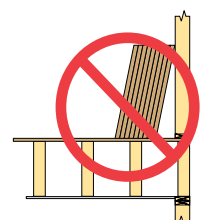
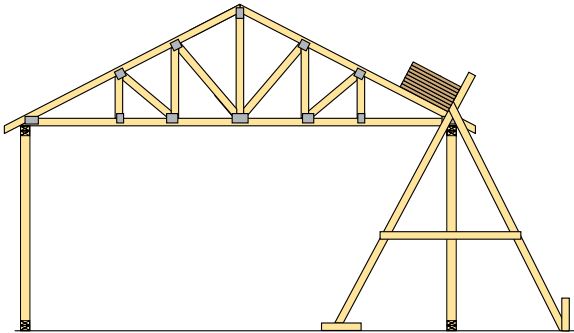


FIGURE B4-3

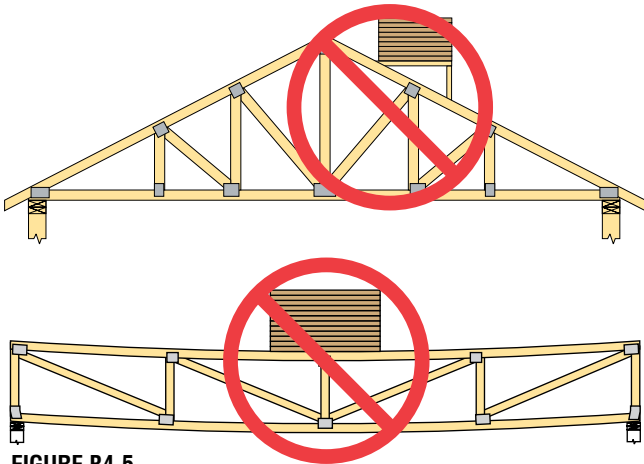
## BCSI-B4: Construction Loading

- ✓ **DO** stack materials along exterior supports or directly over interior supports of properly restrained and braced structures.
- ✓ **DO** restrain Loads to keep from sliding.



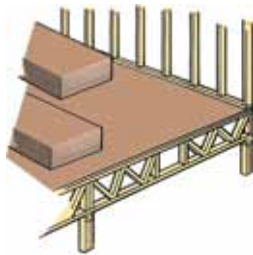
**FIGURE B4-4** Truss bracing not shown for clarity.

- ✗ **DON'T** stack materials at or near the midspan of the Trusses. Never exceed stack heights per Table B4-1, page 53, unless alternative information is provided by the Building Designer, Truss Designer or Truss Manufacturer.



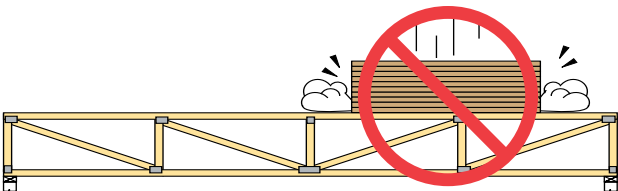
**FIGURE B4-5**

- ✓ **DO** distribute Loads over as many Trusses as possible. Position stacks of materials flat with the longest dimension perpendicular to the Trusses as shown.



**FIGURE B4-6**

- ✗ **DON'T** drop Loads of any materials on Trusses. Truss damage from the impact is possible even if the weight of the material is small.



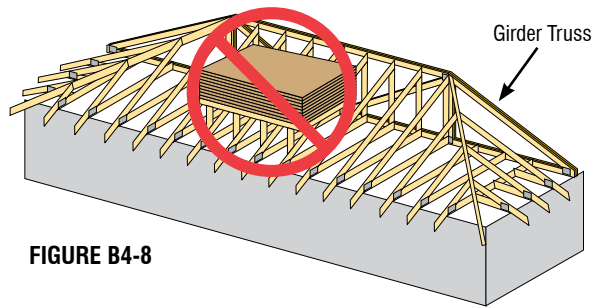
**FIGURE B4-7**

- ✓ **DO** leave construction materials on lifting equipment until installation, if possible.

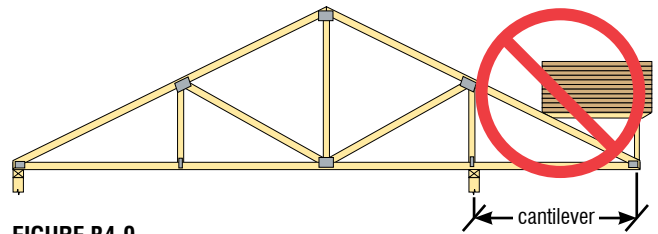


**PHOTO B4-1**

- ✗ **DON'T** stack materials at locations that will produce instability, such as on cantilevers or near Truss-to-Girder Truss Connections.



**FIGURE B4-8**



**FIGURE B4-9**

- ✗ **DON'T** pile cut-off tile and/or other construction waste on Truss roofs.



**PHOTO B4-2**

- ⚠ **WARNING** Excessive Construction Loads on floor or roof Trusses is an unsafe practice and shall be avoided. Property damage, serious personal injury and/or death are possible if these recommendations are not followed.

## TRUSS DAMAGE, JOBSITE MODIFICATIONS & INSTALLATION ERRORS

- ✓ Metal Plate Connected Wood Trusses are pre-fabricated Structural Building Components, assembled with wood members and Truss Plates designed to carry superimposed Loads.
- ✓ Damage, jobsite modifications or improper installation will reduce the strength of a Truss. Seek professional assistance from the Building Designer, Truss Designer or Truss Manufacturer to remedy the condition.
- ✓ Some Truss Manufacturers will mark the Trusses with warnings against jobsite modifications. An example of one such supplemental marking is the Truss tag shown in Figure B5-1.



FIGURE B5-1



PHOTO B5-1

- ⊘ **DON'T** cut Truss Webs. The modification shown in Photo B5-1 requires a repair.
- ✓ The Contractor shall ensure that handling and installation procedures do not reduce the Load carrying capacity of the Truss. See **BCSI-B1** for handling and installation best practices.

### FOLLOW THESE STEPS TO CORRECT DAMAGE, JOBSITE MODIFICATIONS OR INSTALLATION ERRORS

- ✓ If a Truss is damaged, altered or improperly installed:
  1. Temporarily brace or support the Truss to prevent further damage to the Truss and danger to workers.
  2. Report damage, alterations or installation errors to the Truss Manufacturer immediately.
  3. Do not attempt to repair the Truss without a Repair Detail from the Building Designer, Truss Designer or Truss Manufacturer.
  4. Prior to beginning the repair, lay the Truss flat on a solid, level surface. If the Truss is already installed, shore up the Truss to relieve any Load.
  5. Repair the Truss by following the information provided in the Repair Detail exactly. Make sure to use the correct materials as specified. Seek professional guidance if anything is unclear.
  6. Keep the Repair Detail in case the Building Official, Building Designer or Owner requests it.
  7. If the Repair Detail is not for the specific field condition you are repairing, do not use it. Always follow the Repair Detail prepared for your specific situation.
  8. If the designed repair cannot be accomplished, call the Building Designer, Truss Designer or Truss Manufacturer.

### COMMON REPAIR TECHNIQUES

- ✓ Each Repair Detail is generated on a case-by-case basis, since Trusses and the type of damage vary considerably. Some of the more common repairs specified by Truss Designers include:
  - Plywood or oriented strand board (OSB) gussets over damaged plates or joints
  - Metal nail-on plates
  - Lumber scabs or repair frames over broken chords and/or Webs
  - Truss Plates installed by a portable press

## EXAMPLES OF COMMON DAMAGE, MODIFICATIONS AND INSTALLATION ERRORS

Figure B5-2 provides illustrations of commonly reported damage and modifications. If you see one of the conditions detailed below (or anything unusual), follow these steps:

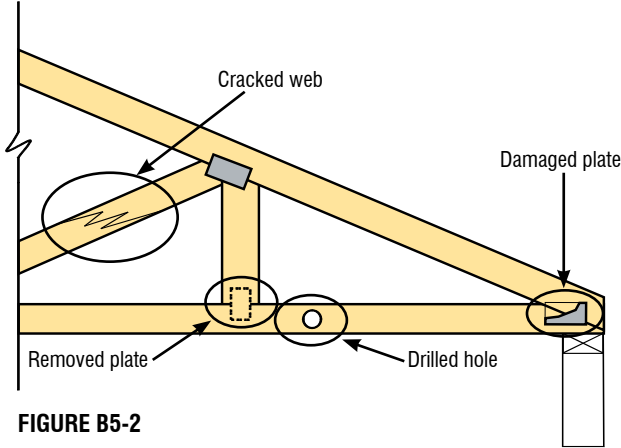


FIGURE B5-2

- ✓ Describe the damage directly on the original Truss Design Drawing (TDD) included in the JOBSITE PACKAGE.

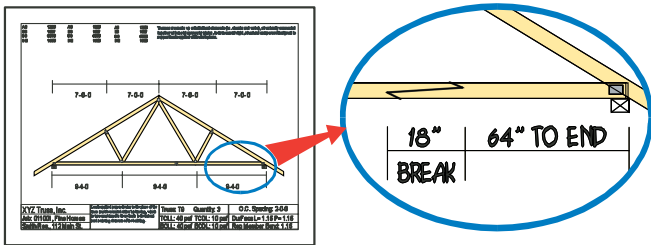


FIGURE B5-3

A great help to starting the repair process is to draw a picture of the damage on the original TDD or take a digital photograph and fax, email or deliver it to the Truss Manufacturer. Be prepared to supply the Truss Manufacturer with the following information:

- ✓ Job name and/or number
- ✓ Truss ID mark
- ✓ Location of the Truss on the Truss Placement Diagram (if one has been provided)
- ✓ Is the Truss installed or is it still in the stack?
- ✓ Is the **lumber damaged**? If so, provide:
  - Exact location of damage from a known location such as a Panel Point or bearing location
  - Description of damage (e.g., crack, break, cut, drilled hole, etc.)
  - Dimension of the damaged area (e.g., 4" break or 2" drilled hole)

- ✓ Is the **plate or joint damaged**? If so, provide:
  - Location or the TDD joint number of the damaged plate or joint
  - Size of the damaged plate
  - Description of plate or joint damage (e.g., loose plate, missing plate, joint gaps, plate peeling, cut, drilled hole, etc.)
  - Indicate if there is damage to one or both faces of the plate/joint
- ✓ Digital photographs of the damaged area, jobsite modifications or installation errors sent as quickly as possible to the Building Designer, Truss Designer or Truss Manufacturer save significant time in trying to explain the site situation or circumstances and will expedite the repair process.
- ✓ Below is an example of a Repair Detail for a Truss that has been shortened.

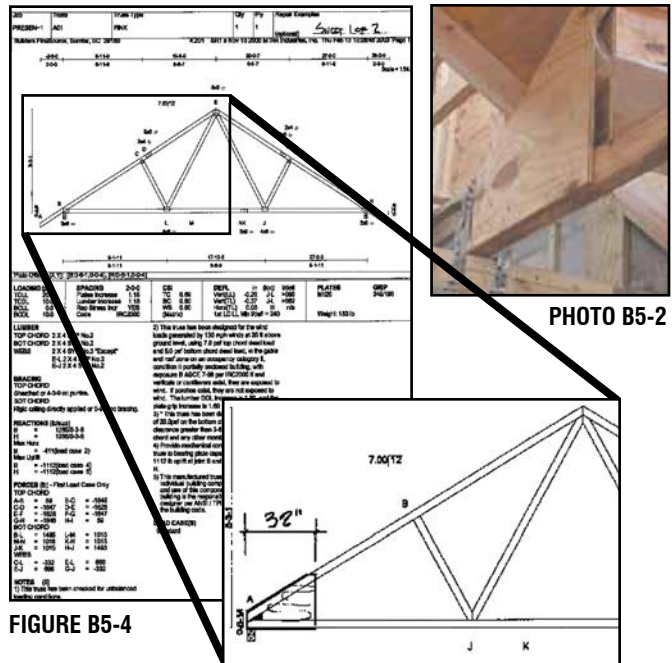


FIGURE B5-4

---

**NOTICE: The information formerly in Section B6, Gable End Frame Bracing, of BCSI 1-03 has been incorporated into Section B3, Permanent Restraint/Bracing of Chords and Web Members, in this edition of BCSI. While Section B6 is currently vacant, it is anticipated that it will be used in future editions of BCSI to provide information on some other aspect involving the handling, installing, restraining or Bracing of Structural Building Components.**

---

**Notes:**



## TEMPORARY & PERMANENT RESTRAINT/BRACING OF 3x2 AND 4x2 PARALLEL CHORD TRUSSES

The restraint and Bracing recommendations discussed in **BCSI-B7** address Parallel Chord Trusses (PCT) built with the wide-face of the lumber oriented horizontally. Refer to **BCSI-B2** for recommendations for PCT built with the wide-face of the lumber oriented vertically.

- ✓ PCT are used primarily in floor and flat roof applications.
- ✓ Both 3x2 and 4x2 lumber are widely used in PCT construction.
- ✓ The wider bearing surface (2.5" for 3x2 and 3.5" for 4x2), shallow depths (typically 24" or less) and relatively short spans (40' or less) make PCT easier to handle and much more stable during the erection/installation process.
- ✓ Top Chord Bearing PCT are more stable than Bottom Chord Bearing Trusses during the erection/installation process because their center of gravity is typically below the bearing surface.

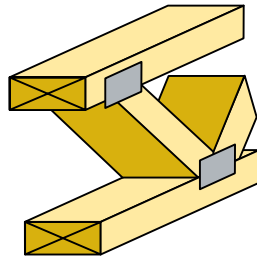


FIGURE B7-1

### STANDARD FLOOR DETAILS

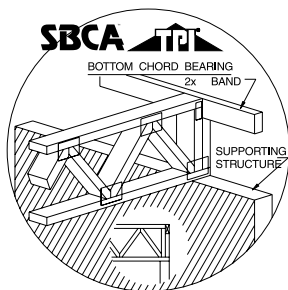


FIGURE B7-2

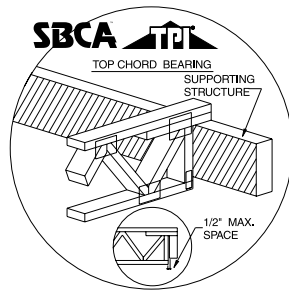


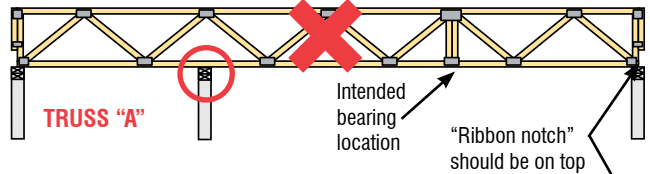
FIGURE B7-3

### STORAGE AND HANDLING

Refer to **BCSI-B1** for information concerning storage and handling of PCT.

### COMMON INSTALLATION ERRORS

Truss "A" is installed "backwards" and "upside down."



Truss "B" is installed correctly.

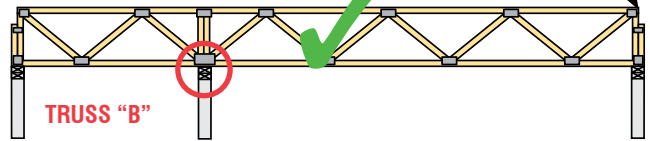


FIGURE B7-4

- ✓ It is critically important that Bottom Chord Bearing PCT be installed with the correct side up and in the correct orientation. Many Truss Manufacturers will use supplemental tags (as shown below) to instruct and warn the Contractor to correctly position Trusses during erection/installation.

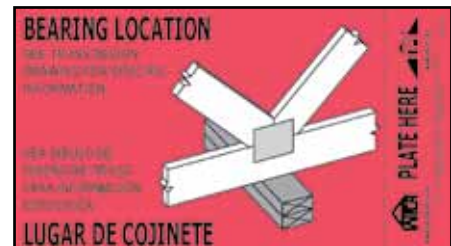


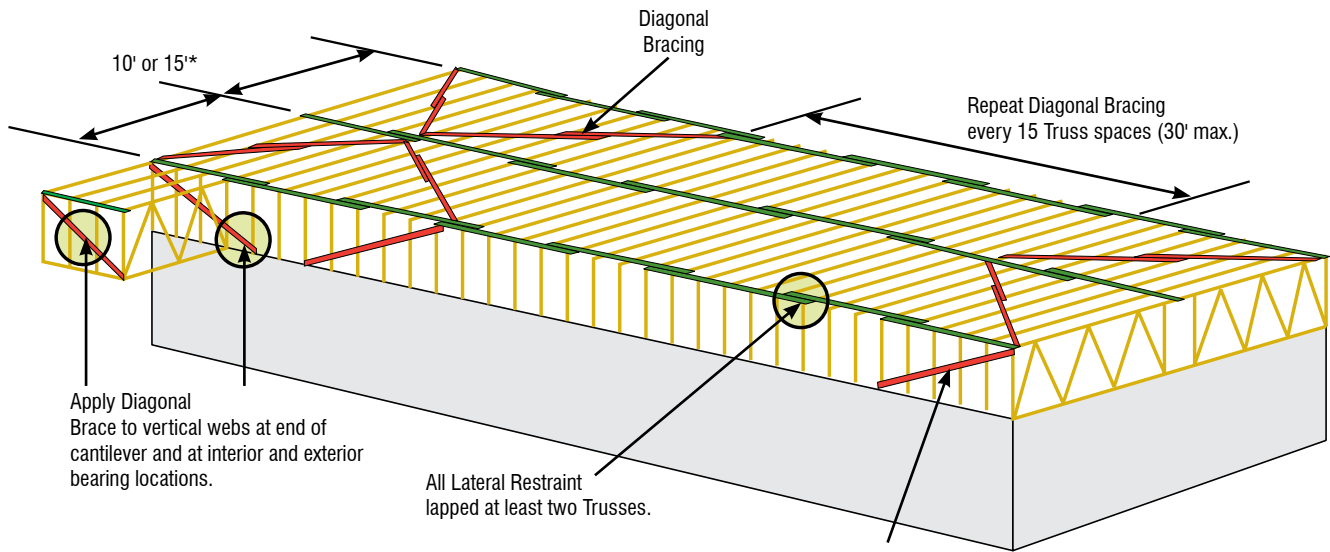
FIGURE B7-5



FIGURE B7-6

- ✓ Lateral Restraint and Diagonal Bracing of PCT are extremely important.
- ✓ Spacing between rows of Top Chord Temporary Lateral Restraint (TCLR) shall not exceed 10' on-center (o.c.) for 3x2 chords, and 15' o.c. for 4x2 chords.
- ✓ Diagonal Bracing is critical and shall be installed at a maximum of every 15 Truss spaces or less.

## INSTALLATION RESTRAINT/BRACING REQUIREMENTS



**FIGURE B7-7**

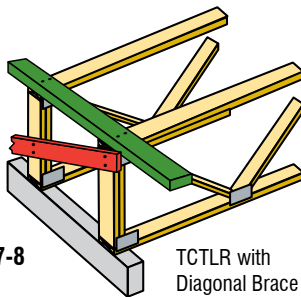
See **NOTICE** and Figures B7-8, 9, 10 and 11 below. Repeat every 15 Truss spaces (30' max.)

\*Spacing between rows of Top Chord Temporary Lateral Restraint (TCLR) shall be 10' o.c. max. for 3x2 chords and 15' o.c. for 4x2 chords.

- ✓ End diagonals, with TCLR or Ribbon (band) board, Blocking Panels, or Rim board (see Figures B7-8, 9, 10 and 11) are examples of framing components that provide stability to the PCT during installation. Install one of these types of components on both ends of the Truss System and repeat every 15 Truss spaces (30' maximum), see Figure B7-7.

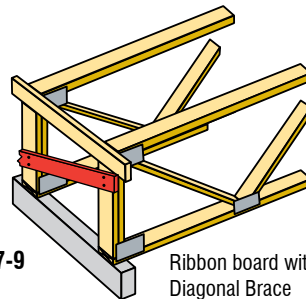
- ✓ For Bottom Chord Bearing Trusses, TCLR at Truss ends are not required if Blocking panels, Ribbon board or Rim board are used. See details in Figures B7-9, 10 and 11.
- ✓ Bottom Chord Permanent Lateral Restraint shall be installed in rows not exceeding 10' o.c. or as directed by the Construction Documents or Building Designer.

**NOTICE** Structural Sheathing, Ribbon board with Structural Sheathing, Blocking panels, or Rim board are also capable of transferring lateral Loads as part of the Permanent Building Stability Bracing (PBSB) system if installed in accordance with the PBSB specifications.



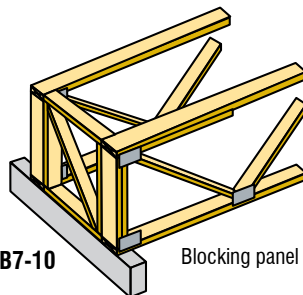
**FIGURE B7-8**

TCLR with Diagonal Brace



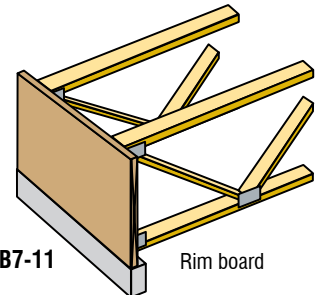
**FIGURE B7-9**

Ribbon board with Diagonal Brace



**FIGURE B7-10**

Blocking panel



**FIGURE B7-11**

Rim board

## PERMANENT RESTRAINT & BRACING

- ✓ Permanently restrain and brace the top chords of the PCT with properly sized and attached structural sheathing.
- ✓ Permanently restrain and brace the bottom chords of the PCT with directly applied gypsum panel ceiling or with rows of lateral restraint installed at 10' on-center along the Truss span and diagonal bracing installed at no more than 20' intervals along the run of Trusses, unless otherwise specified.
- ✓ Install Structural Sheathing, Ribbon board with Structural Sheathing, Blocking panels, or Rim board (see Figures B7-8,9,10 and 11 on page 60) at the bearing locations of bottom chord bearing PCT as specified by the Building Designer to transfer lateral diaphragm forces to the shear walls.
- ✓ Install solid blocking directly beneath load bearing columns to maintain a load path through the floor to the supporting structure below.

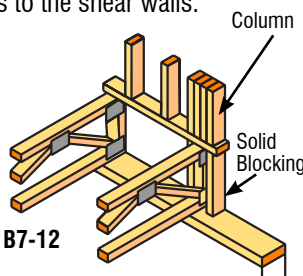


FIGURE B7-12

## STRONGBACKING PROVISIONS

Strongbacking is intended to enhance the performance of the Truss by helping to limit differential deflection between adjacent Trusses and to reduce vibration. Strongbacking is generally attached to vertical Webs or scabs at specified intervals and locations. ANSI/TPI 1 provides the following provisions for using Strongbacking:

- ✓ Use a minimum 2x6 (nominal) lumber oriented with the depth vertical.
- ✓ Attach the Strongbacking to each Truss with a minimum of three (3) 10d (0.131x3.0") nails. Shim the joint between the Strongback and Truss to ensure a solid Connection.
- ✓ The Strongbacking shall be as continuous as possible. When required to be cut, removed, or modified to allow for the installation of mechanical and/or plumbing lines, the continuity at the adjoining floor sections shall be maintained as specified by the designer specifying the Strongbacking.
- ✓ Spacing between Strongbacking shall not exceed 10'.

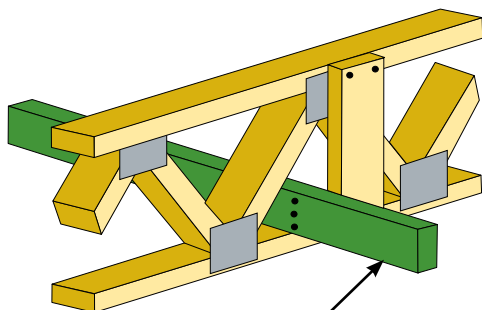


FIGURE B7-13

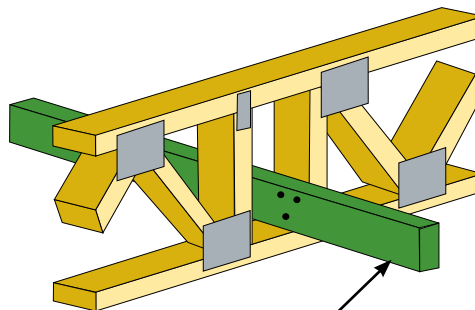


FIGURE B7-14

- ✓ When specified to control vibration in floor assemblies, or to protect brittle floor surfaces such as ceramic tile and stone, the Contractor shall locate the Strongbacking as stipulated on the Truss Design Drawing and as required by the floor surfacing specifications unless otherwise specified.
- ✓ When specified to control deflection in floor assemblies, unless otherwise specified, install one Strongback near the centerline of the Truss clear span when the deflection due to live Load exceeds 0.67" and install two Strongbacks near the centerline of the clear span, or near the third points of the Truss Span, when the live Load deflection exceeds 0.85".
- ✓ Floor Trusses with ceilings attached that meet span/480 live Load deflection criteria do not require Strongbacking, unless required for a specific fire-rated assembly or specified in the Construction Documents.
- ✓ Cross bridging is permitted as an alternative to Strongbacking as determined by the designer specifying the Strongbacking.
- ✓ Attach the ends of each row of Strongbacks to a wall or another secure end restraint.
- ✓ Many Truss Manufacturers will also include a supplemental tag, such as the one shown below, to further assist the erection/installation Contractor in correctly installing Strongbacking.

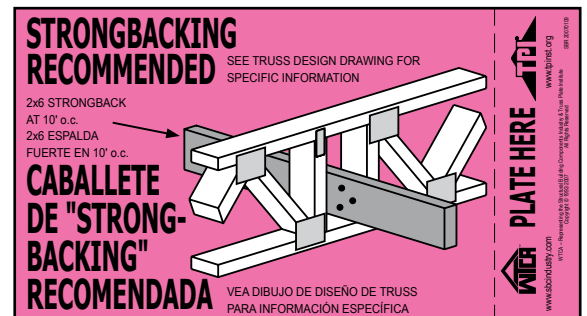


FIGURE B7-15



**WARNING: LATERAL RESTRAINT & DIAGONAL BRACING ARE VERY IMPORTANT!**



FIGURE B7-16

# BCSI-B7: Temporary & Permanent Restraint/Bracing for Parallel Chord Trusses

⊘ **DO NOT** walk on unbraced Trusses.

## CONSTRUCTION LOADING

- ✓ Construction materials shall be distributed properly. See **BCSI-B4** for additional information.
- ✓ Always stack materials over two or more Trusses.

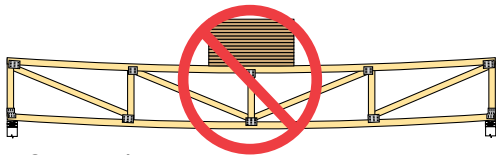


FIGURE B7-17

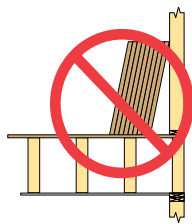


FIGURE B7-18

- ⊘ **NEVER** overload small groups or single Trusses. Do not lean stacks of materials against walls.
- ⊘ **DON'T** drop Loads of any material on Trusses. Truss Damage from the impact is possible even if the weight of the material is small.

✓ Position load over as many Trusses as possible with longest dimension perpendicular to Trusses.

✓ Place material next to outside Load bearing wall or directly over interior bearing wall.

✓ Position stacks of materials flat with the longest dimension perpendicular to the Trusses as shown in Figure B7-19.

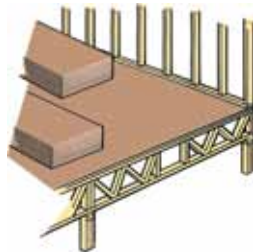


FIGURE B7-19

Maximum Stack Height for Material on Trusses <sup>1,2</sup>	
Material	Height
Gypsum Board	12"
Plywood or OSB	16"
Asphalt Shingles	2 bundles
Concrete Block	8"
Clay Tile	3-4 tiles high

TABLE B7-1

1. This table is based on Trusses designed with a live Load of 40 psf or greater. For other Loading conditions, contact a Registered Design Professional.
2. Stack heights assume short-term duration of Load. Install stacks of materials as quickly as possible.

**Note:** Heavy roofing tile, such as clay or stone slate, is often “dry-stacked” on the roof for a period of time to allow the roof/ceiling assembly time to “settle” before the finished ceiling is installed. Limit stack heights to those provided in Table B7-1 and stacking periods to approximately one week, unless alternative information is provided by the Building Designer, Truss Designer or Truss Manufacturer.

## ALTERATIONS

⊘ **DO NOT** cut, alter, or drill any structural member of a Truss unless specifically permitted by the Truss Design Drawing.

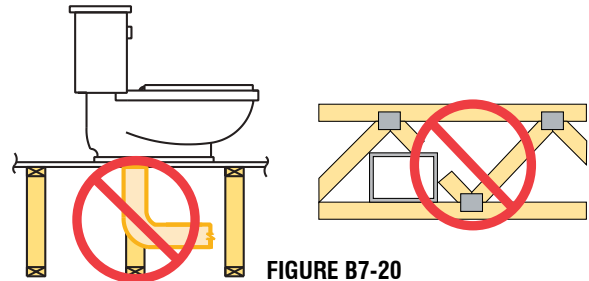


FIGURE B7-20

**NOTICE** Trusses that have been overloaded during construction or altered without the Truss Manufacturer’s prior approval will render the Truss Manufacturer’s limited warranty null and void.

**NOTICE** Refer also to **BCSI-B5** Truss Damage, Jobsite Modifications & Installation Errors.

## SPECIAL CONDITIONS

**NOTICE** Attachment of residential decks to Trusses requires the use of a standard detail provided by the Truss manufacturer or by a registered design professional. An alternative is to use a free standing deck.

✓ Refer to the SBCA Tech Note – *Attachment of Residential Decks to Wood Truss Floor Systems* for special blocking details and attachment requirements (sbcindustry.com).

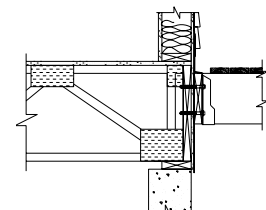


FIGURE B7-21

⊘ **DO NOT** attach the deck ledger to 2x\_ ribbon board unless a special detail has been provided by the Truss Designer or Building Designer.

## USING TOE-NAILED CONNECTIONS TO ATTACH TRUSSES AT BEARING LOCATIONS

### GENERAL

- ✓ Metal Plate Connected Wood Trusses are typically designed to bear directly on top of a wall or beam, or to frame into the side of a Girder Truss. In many instances, a Toe-nailed Connection can be used to attach the Truss to the support. As with any Connection, the Toe-nailing shall be capable of resisting and transferring the applicable loads.

### FACTORS AFFECTING THE STRENGTH OF A TOE-NAILED CONNECTION

- ✓ The resistance provided by a Toe-nailed Connection is governed by the following factors:

#### 1. Proper Installation

To get the most out of a Toe-nailed Connection, it is important to Toe-nail correctly. Figure B8-1 illustrates proper Toe-nailing of a Truss to the wood top plates of a bearing wall. The dimensions shown are only meant to serve as an approximate guide. Toe-nailing through a Metal Connector Plate of a Truss does not adversely affect the uplift capacity of the Connection, provided the Truss Plate and lumber are not damaged during installation.

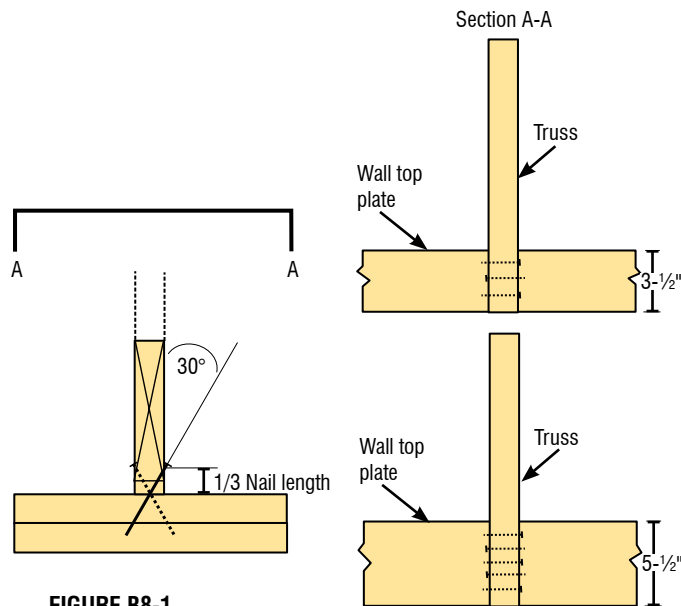


FIGURE B8-1

#### 2. Species of Lumber

The species of wood that the nail is driven into also affects the amount of resistance provided by a Toe-nailed Connection. More specifically, nail resistance to withdrawal and lateral forces is directly related to the specific gravity (SG) of the wood. For example, a Toe-nailed Connection into Southern Pine (SG = 0.55) will provide greater resistance than the same Connection into Spruce-Pine-Fir (SG = 0.42).

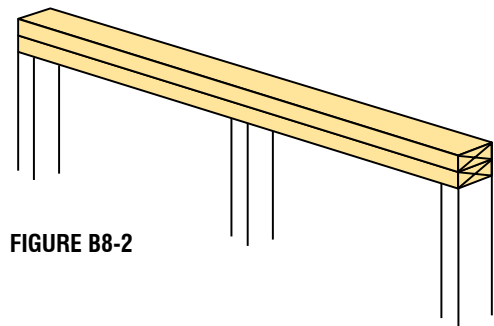


FIGURE B8-2

#### 3. Length of Penetration

The withdrawal and lateral resistance provided by a nail depends, in part, on the length of penetration into the wood member. The greater the penetration, the greater the resistance.

#### 4. Type of Nail

The type of nail used in a Toe-nailed Connection also influences capacity. The larger the diameter of the nail shank, the greater the resistance to withdrawal and lateral Loads. For this reason, common wire nails provide greater resistance than the same size (i.e., penny-weight) of box, sinker or gun nails. The type of nail shank will also influence nail holding capacity. Deformed shank (i.e., ring- or screw-shank) typically provide greater withdrawal resistance than smooth shank nails.

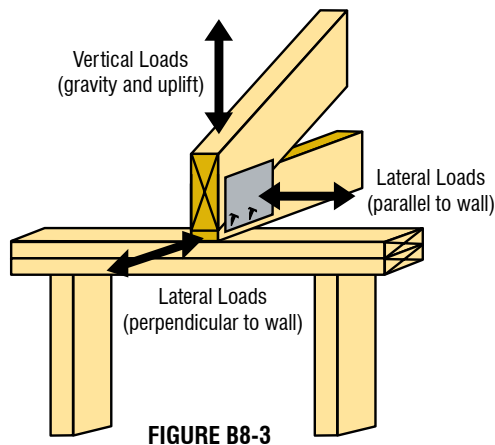
- ✓ When installing Toe-nails, use care to avoid splitting the wood. The Building Designer typically provides nail spacing and minimum end and edge distances. In lieu of such guidance, a well accepted rule is to limit the total number of Toe-nails to three (total, including both sides) for full bearing on a 2x4 top plate (i.e., 3-1/2") and five (total, including both sides) for full bearing on a 2x6 top plate (i.e., 5-1/2") (see Figure B8-1). When using Toe-nails to attach the Top or Bottom Chord of a Truss to the side of a Girder Truss or wood beam, the number of nails used is generally limited to a maximum of three Toe-nails for 2x4 chords and four Toe-nails for 2x6 chords.

## BCSI-B8: Using Toe-Nailed Connections to Attach Trusses at Bearing Locations

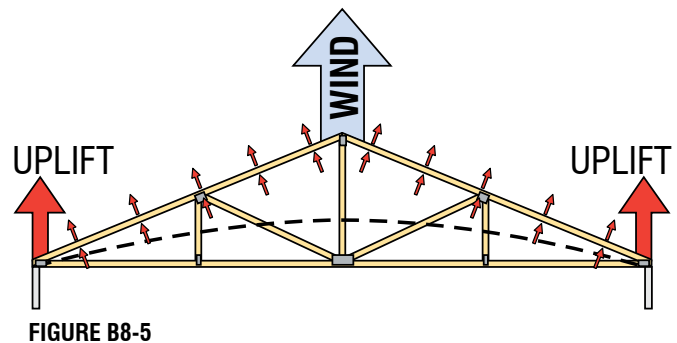
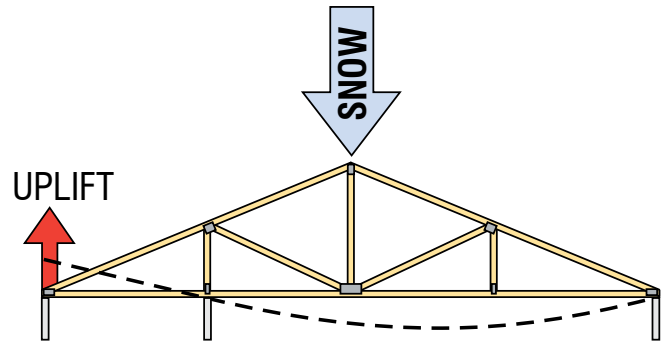
- ✓ The National Design Specification® (NDS®) for Wood Construction provides the engineering basis for Toe-nail and slant-nail Connections when used to resist withdrawal and lateral Loads. The design values included in this document were developed using the provisions of the 2012 edition of NDS®.

### TOE-NAILING USED WITH BOTTOM BEARING APPLICATIONS

- ✓ Trusses designed to bear directly on top of a structural wood support are often attached by Toe-nailing the Truss chord to the support. Toe-nailing used in this type of application is typically required to resist uplift and lateral forces.

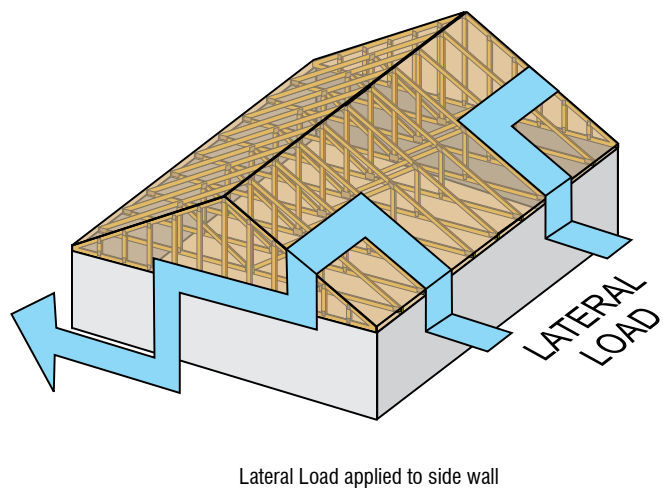
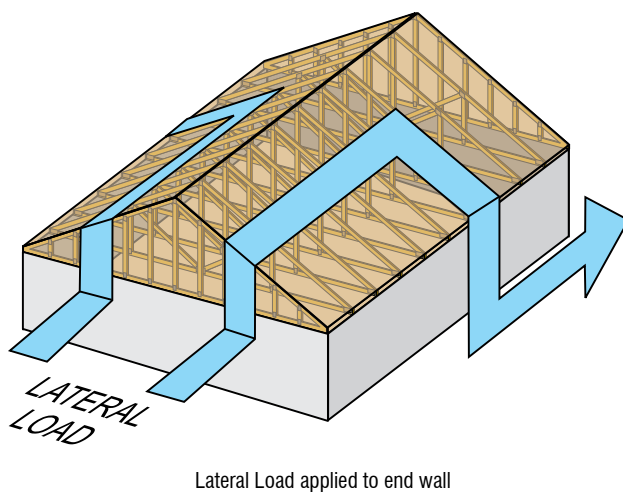


- ✓ Wind Loads acting on a Truss, as well as certain multi-span Truss applications supporting gravity Loads, can produce uplift reactions at Truss bearing locations. The magnitudes of these uplift reactions are typically provided on the Truss Design Drawing (TDD).



- ✓ Wind and seismic forces acting on the Building produce lateral Loads that are often transferred at the Truss bearing locations. The magnitude and direction of these wind and seismic Loads are to be provided by the Building Designer.

### Example of lateral Load paths through the roof of a Building



**FIGURE B8-6**

## HOW MUCH UPLIFT AND LATERAL RESISTANCE CAN TOE-NAILING PROVIDE?

Table B8-1 provides the uplift and lateral Load capacities of Toe-nailed Connections consisting of three, four or five nails for various types of nails and species of wood. The table assumes the nails are installed a distance of either L/3 (i.e., length of nail divided by 3) or 1-1/8" from the top surface of the plate (support) (Figure B8-1, page 63). The values listed are for normal Load duration and are permitted to be multiplied by the Load duration factor (Table B8-2, page 66) appropriate for the specific application.

**Example:** A Truss manufactured with SPF chords and Webs bears on top of a bearing wall with double 2x6 SPF top plates. The TDD for this Truss indicates a maximum uplift reaction due to wind of 225 lbs. From the columns marked "Uplift Capacity" in Table B8-1, a Toe-nailed Connection of either 5-16d 0.131" diameter nails

(i.e.,  $150 \times 1.6 = 240 \text{ lbs} > 225$ ), 5-16d box nails (i.e.,  $155 \times 1.6 = 248 \text{ lbs} > 225$ ), or 5-12d common nails (i.e.,  $155 \times 1.6 = 248 \text{ lbs} > 225$ ) would be required to resist this uplift, using a Load duration factor of 1.6 for wind.

The calculated lateral resistance capacity of each of these Toe-nailed Connections can be determined from the righthand side of Table B8-1. The Connections consisting of 5-16d (0.131x3.5") nails can resist a lateral Load due to wind of  $340 \times 1.6 = 544 \text{ lbs}$  at a Load duration factor of 1.6. Similarly a Connection using 5-16d box nails can resist approximately 584 lbs, and a Connection with 5-12d common nails can resist approximately 664 lbs.

**Note:** Uplift and lateral Loads can occur simultaneously and the capacity of Toe-nailed Connections should be evaluated under this combined Loading. It is best to have the Building Designer evaluate the Load transfer path and the Truss to bearing Connection to determine what is required.

**TABLE B8-1 Nominal Uplift and Lateral Capacity per Toe-Nail Joint Connection into Double Top Plate of Wall<sup>1</sup>**

Nail Type & Size <sup>2</sup>	No. of Toe-Nails	Uplift Capacity (lbs) with Common Species <sup>3,4,5</sup>					Lateral Resistance Capacity (lbs) with Common Species <sup>3,4</sup>				
		Load Duration Factor = 1.0									
		SP (SG = 0.55)	DF-L (SG = 0.50)	HF (SG = 0.43)	SPF (SG = 0.42)	SPF(s) (SG = 0.36)	SP (SG = 0.55)	DF-L (SG = 0.50)	HF (SG = 0.43)	SPF (SG = 0.42)	SPF(s) (SG = 0.36)
16d (0.131x3.5")	3	174	138	96	90	60	264	243	210	204	180
	4	232	184	128	120	80	352	324	280	272	240
	5	290	230	160	150	100	440	405	350	340	300
12d (0.120x3.25")	3	147	114	78	75	51	222	204	177	171	150
	4	196	152	104	100	68	296	272	236	228	200
	5	245	190	130	125	85	370	240	295	285	250
10d (0.120x3.0")	3	126	99	69	66	45	222	204	177	171	150
	4	168	132	92	88	60	296	272	236	228	200
	5	210	165	115	110	75	370	240	295	285	250
10d (0.131x3.0")	3	138	108	75	72	48	264	243	210	204	180
	4	184	144	100	96	64	352	324	280	272	240
	5	230	180	125	120	80	440	405	350	340	300
16d Box (0.135x3.5")	3	180	141	99	93	63	282	258	222	219	189
	4	240	188	132	128	84	376	344	296	292	252
	5	300	235	165	155	105	470	430	370	365	315
10d Box (0.128x3.0")	3	135	108	72	69	48	252	231	201	195	171
	4	180	144	96	92	64	336	308	268	260	228
	5	225	180	120	115	80	420	385	335	325	285
8d Box (0.113x2.5")	3	84	66	45	42	30	198	180	156	153	132
	4	112	88	60	56	40	264	240	208	204	176
	5	140	110	75	70	50	330	300	260	255	220
16d Common (0.162x3.5")	3	216	171	117	111	75	384	351	304	297	261
	4	288	228	156	148	100	512	468	404	396	348
	5	360	285	195	185	125	640	585	505	495	435
12d Common (0.148x3.25")	3	180	141	96	93	63	321	294	255	249	216
	4	240	188	128	124	84	428	392	340	332	288
	5	300	235	160	155	105	535	490	425	415	360
10d Common (0.148x3.0")	3	156	123	84	81	54	321	294	255	249	216
	4	208	164	112	108	72	428	392	340	332	288
	5	260	205	140	135	90	535	490	425	415	360
8d Common (0.131x2.5")	3	99	78	54	51	33	243	222	192	186	165
	4	132	104	72	68	44	324	296	256	248	220
	5	165	130	90	85	55	405	370	320	310	275

**Footnotes:**

1. a. The capacities in this table are for normal load duration and assume moisture, temperature and end grain factor of 1.0. Refer to NDS<sup>®</sup> if other adjustments are required.
- b. Apply fire retardant treated lumber adjustment factors per manufacturer's specifications.
- c. Per NDS<sup>®</sup>, edge distances, end distances and spacing shall be sufficient to prevent the splitting of the wood.
2. For capacities of nail types and sizes not shown, consult a Registered Design Professional.

3. Nominal uplift and lateral resistance capacities are based on wood species of the top plate, where SP = Southern Pine, DF-L = Douglas Fir-Larch, HF = Hem-Fir, SPF = Spruce-Pine-Fir, and SPF(s) = Spruce-Pine-Fir (South).
4. If the Truss Bottom Chord and wall plate are different species, use the species with the lowest specific gravity to determine the lateral Load capacity of the fasteners.
5. Nominal uplift capacities assume full penetration of the Toe-nail into the top plate. Double 2x\_ plates are required for nail lengths greater than 2.69".

**Note:** Trusses are intended to carry Loads applied parallel to their plane (i.e., depth) and not perpendicular to it. The lateral Load transfer through the Truss as depicted in Figure B8-7 occurs unless Blocking or some other means is provided that will transfer this Load directly between the roof sheathing and top plate of the wall.

Trusses shall be permitted to transfer load between diaphragms and supporting walls, provided the prescriptive provisions specified in Section R602.10.8.2 of the 2012 IRC are met. Conditions outside these prescriptive provisions may require blocking or other means to transfer the lateral load from the diaphragm into the walls.

## LOAD DURATION FACTOR, $C_D$ (FOR CONNECTIONS)

TABLE B8-2 Load Duration Factor,  $C_D$  (for Connections)

LOAD DURATION	$C_D$	TYPICAL DESIGN LOAD
Permanent	0.9	Dead Loads
10 Years (Normal)	1.0	Floor Live Loads
2 Months	1.15	Snow Loads
7 Days	1.25	Construction Loads
10 Minutes/Impact	1.33/1.6*	Wind/Earthquake

\*Check with local code.

Lateral Load transfer between the roof Diaphragm and supporting wall is through the heel of the Truss unless some other means is provided to transfer this Load directly between the roof sheathing and the wall plate.

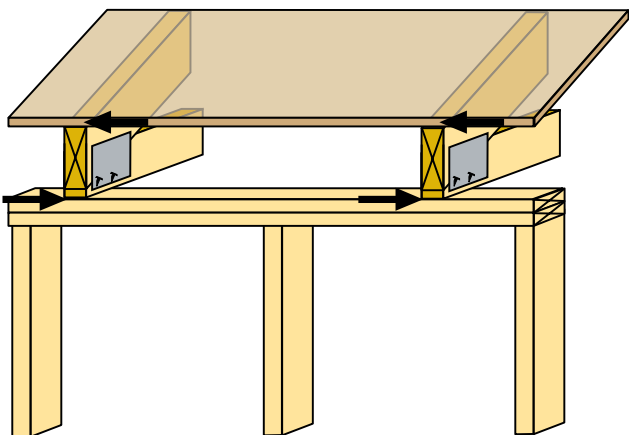


FIGURE B8-7

## TOE-NAILING USED TO ATTACH JACK TRUSSES TO A GIRDER

- ✓ Toe-nailing is often used to attach corner and end jack Trusses to Girder Trusses. The relatively short spans and light end reactions associated with typical jack Truss applications makes Toe-nailing an efficient and effective attachment method.

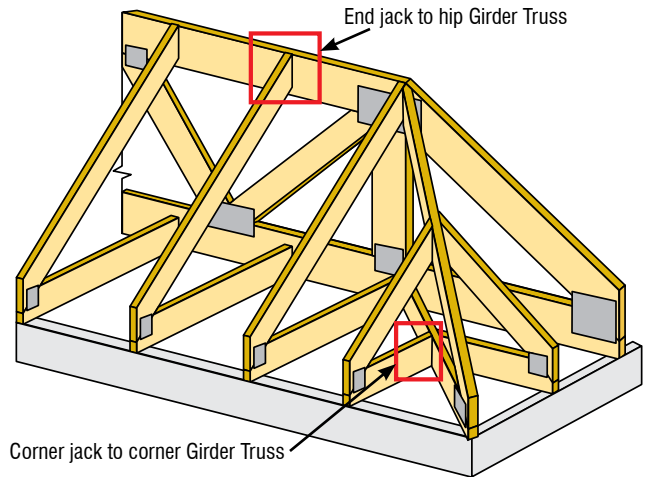


FIGURE B8-8 Open Jack Hip Framing

- ✓ Table B8-3, page 67, provides the nominal lateral design capacity of Toe-nailed Connections consisting of two-, three-, and four-nails for various types of nails and species of wood. The capacities listed are for Toe-nailed Connections attaching the Top and Bottom Chords of a 2x\_ end jack Truss to a single or multiple 2x\_ hip Girder Truss (Figure B8-9, page 67) or for the Toe-nailed Connections attaching the Top and Bottom Chords of a 2x\_ corner jack Truss to a corner Girder Truss that intersect at angles from 30° to 60° (Figure B8-10, page 67).

**Note:** The nails for these Connections are assumed to be installed at either  $L/3$  (i.e., length of nail divided by 3) or 1-1/8" from the end of the jack Truss (Figures B8-9 and 10, page 67). Also, the Connection between the corner jack and corner Girder Truss assumes that the nails are driven normal to the face of the jack into the Girder Truss as depicted in (Figure B8-10, page 67).

- ✓ To reduce the chance of splitting, rafter Connections, such as those depicted here, are typically limited to a maximum of three Toe-nails for 2x4 chords and four Toe-nails for 2x6 chords.



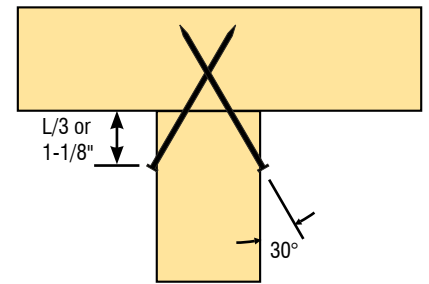
# BCSI-B8: Using Toe-Nailed Connections to Attach Trusses at Bearing Locations

**TABLE B8-3 Nominal Lateral Capacity per Toe-Nail Joint Connection for Attaching Jack Trusses to Girders<sup>1</sup>**

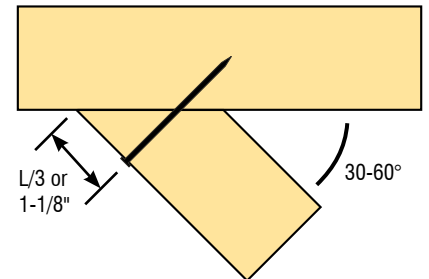
Nail Type & Size (Dia. & Length)	Number of Toe-Nails per Connection	Capacities for Truss Chord Species (lbs)				
		Load Duration Factor = 1.0				
		SP G = 0.55	DF-L G = 0.5	HF G = 0.43	SPF G = 0.42	SPF(s) G = 0.36
16d (0.131" x 3.5")	2	158	140	114	110	92
	3	237	210	171	165	138
	4	316	280	228	220	184
12d (0.120" x 3.25")	2	138	120	98	94	78
	3	207	180	147	141	117
	4	276	240	196	188	156
10d (0.120" x 3.0")	2	130	116	94	92	76
	3	195	174	141	138	114
	4	260	232	188	184	152
10d (0.131" x 3.0")	2	142	130	108	106	90
	3	213	195	162	159	135
	4	284	260	216	212	180
16d Box (0.135" x 3.5")	2	166	146	120	116	96
	3	249	219	180	174	144
	4	332	292	240	232	192
10d Box (0.128" x 3.0")	2	138	126	104	102	86
	3	207	189	156	153	129
	4	276	252	208	204	172
16d Common (0.162" x 3.5")	2	214	188	156	152	128
	3	321	282	234	228	192
	4	428	376	312	304	256
12d Common (0.148" x 3.25")	2	182	160	132	128	108
	3	273	240	198	192	162
	4	364	320	264	256	216
10d Common (0.148" x 3.0")	2	152	140	120	116	94
	3	228	210	180	174	141
	4	304	280	240	232	188

**Footnotes:**

- 1.a. Nominal lateral design capacities have been adjusted by the Toe-nail factor and represent normal Load duration values. To determine the adjusted lateral design values, multiply the table values by all other applicable adjustment factors provided in NDS<sup>®</sup>.
- b. Nominal lateral capacities are based on framing conditions depicted in Figures B8-9 and 10.
- c. Nominal lateral capacities are for a single-shear Connection with both members of the same species. If the two members are of different species, use the species with the lowest specific gravity to determine the lateral load capacity of the Connection.
- d. Species designation is: SP = Southern Pine, DF-L = Douglas Fir-Larch, HF = Hem-Fir, SPF = Spruce-Pine-Fir and SPF(s) = Spruce-Pine-Fir (South).
- e. Nominal lateral capacities assume the side member and main member are both 1-1/2" thick.
- f. Apply fire retardant treated lumber adjustment factors per manufacturer's specifications.
- g. For capacities of nail types and sizes not shown, consult a Registered Design Professional.



**FIGURE B8-9** End jack to hip Girder Truss



**FIGURE B8-10** Corner jack to corner Girder Truss

## OTHER TYPES OF UPLIFT CONNECTIONS

If the Truss reactions due to the design Loads are greater than the capacity of the Toe-nailed Connection, it will be necessary to use a different type of Connection. Options include a screwed Connection, designed in accordance with the applicable provisions of NDS®, a metal anchor, strap, tie or hanger Connection, such as the ones shown below. Please refer to the hardware manufacturer's literature for uplift and lateral Load capacities of the hardware, the fastener schedules, and specific requirements for positioning the Connector.

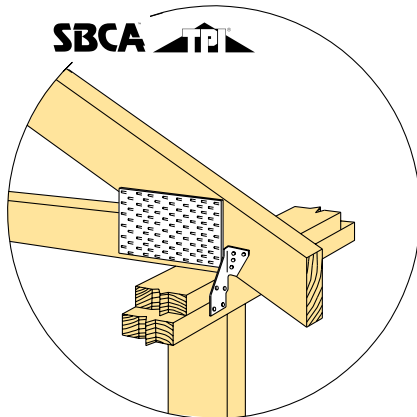


FIGURE B8-11

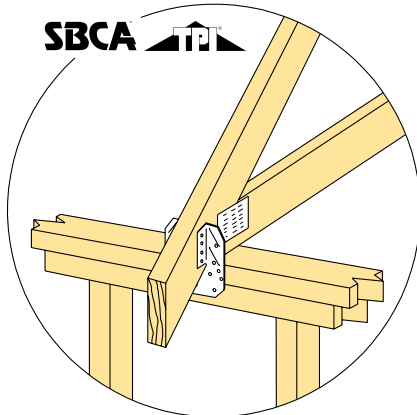


FIGURE B8-12

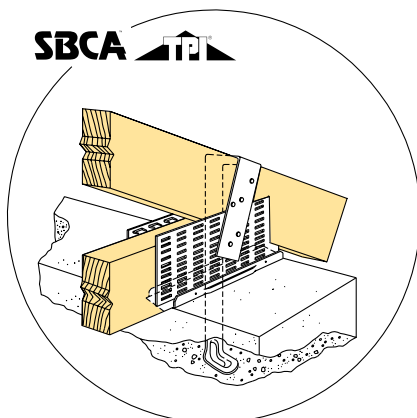


FIGURE B8-13

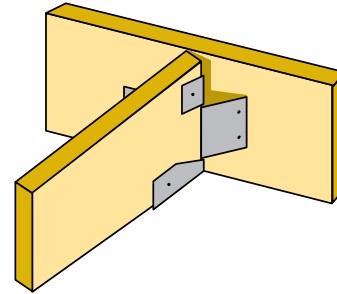


FIGURE B8-14

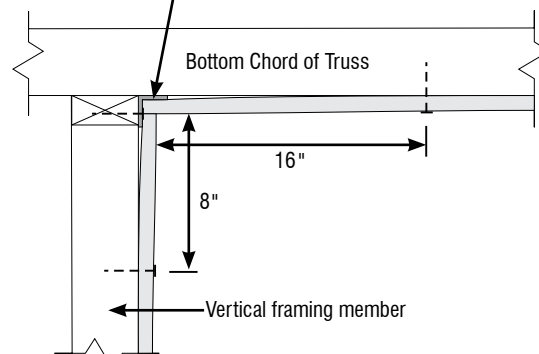
- ✓ Some Building codes specify Connection requirements between the Truss and the bearing surface. It is imperative that the installer be familiar with the requirements that apply for each job.

## NON-BEARING WALL CONSIDERATIONS

Attachments to non-bearing interior walls must allow for a Floating Connection to prevent the occurrence of partition separation.

- ⊘ DO NOT shim.

Clip or angle fastened to top plate of wall at 16" o.c.



See below for fastening Truss to top plate.

FIGURE B8-15 Floating gypsum corner (Truss perpendicular to wall)

Float gypsum at wall Corners as shown above.

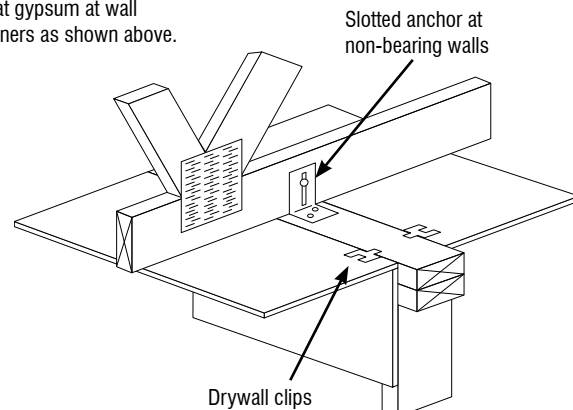


FIGURE B8-16 Use of drywall clips and slotted anchor on non-bearing wall

## MULTI-PLY GIRDERS

Girders are Trusses specially designed to carry extra Loads from framing and equipment. Girder Trusses may consist of a single ply or as many as six plies. The Truss Designer will specify the number of members in a multi-ply Girder Truss. In the photo below, a 4-ply parallel chord Girder Truss is supported at one end by a 3-ply Girder Truss with a pitched Top Chord. Each Girder Truss is made of similar Trusses built and fastened together to act as one unit to support the Load.



PHOTO B9-1

### PLY-TO-PLY CONNECTION REQUIREMENTS

✓ All plies in a multi-ply Girder Truss shall be properly attached together to ensure the Girder Truss is able to perform according to its design.

**⚠ WARNING** Girder Truss plies shall be completely and securely attached together per the Connection requirements provided on the Truss Design Drawing (TDD) prior to attaching the Trusses that frame into them and any other Loads they are required to support.

**NOTICE** Whenever possible, connect multi-ply Girder Trusses together **prior** to erection/installation.

✓ Always check the TDD for the Girder Truss ply-to-ply Connection requirements. They are listed in the fastener schedule and will specify the type, size and on-center spacing of fasteners to use.

For example, the fastening schedule for this 3-ply Girder Truss is shown in Figure B9-1:

Nailing Schedule: 12d (0.128" x 3.25") nail  
 TOP CHORD: 1 ROW @ 5" o.c.  
 BOT CHORD: 2 ROWS @ 12" o.c.  
 WEBS: 1 ROW @ 4" o.c.

Repeat nailing as each layer is applied. Use equal spacing between rows and stagger nails in each row to avoid splitting.

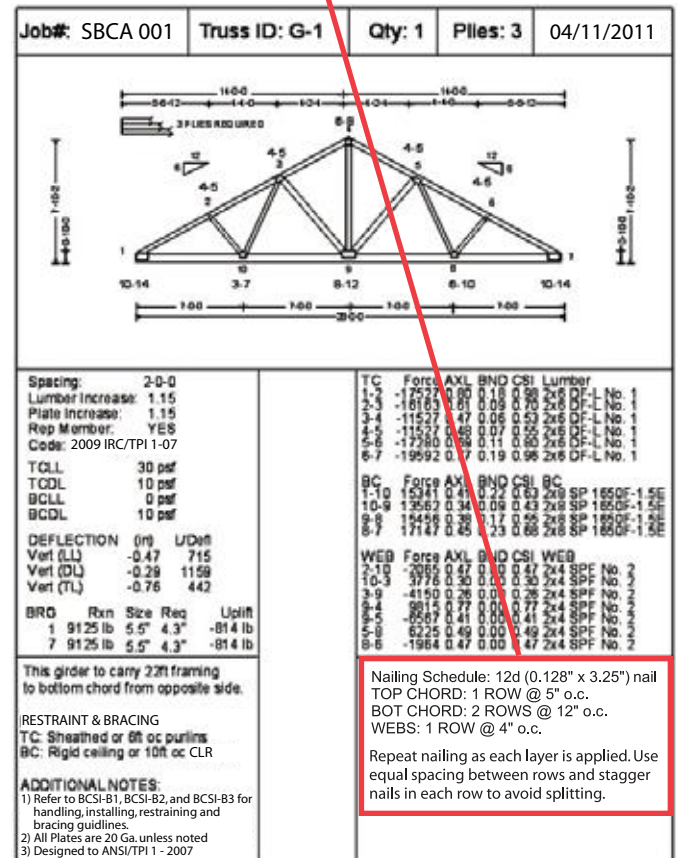


FIGURE B9-1

- ✓ Concentrated Load locations often require nail clusters.
- ✓ Check TDD carefully for additional fastening requirements.

## GOOD INSTALLATION PRACTICES

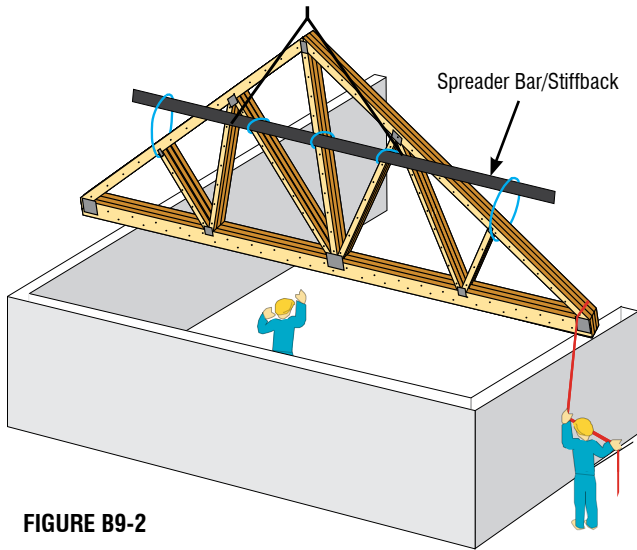


FIGURE B9-2

- Some Truss Manufacturers mark Girder Trusses with supplemental tags, calling further attention to the number of plies and fastening schedule on the TDD. An example of one such Truss tag is shown in Figure B9-3.

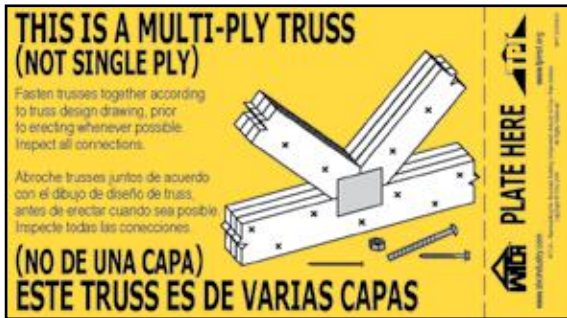


FIGURE B9-3

- Fasten girder plies together per TDD before lifting into place, if at all possible.
- Multi-ply Parallel Chord Trusses have special Connection requirements due to the 3x\_ or 4x\_ configuration and shall be joined together according to the Truss Designer's specifications. Connection options typically include metal framing anchors (Figure B9-11, page 71), Structural Sheathing, metal gussets and proprietary high-strength screws (Figures B9-12 and 13, page 71).
- Make sure that the Girder Truss is laterally restrained and braced to ensure lateral stability and prevent unexpected deflection or rotation.
- Attach framing members or Loads only after all plies of the Girder Truss have been properly fastened together. This avoids overloading the girder ply closest to the carried Load.
- Truss-to-girder Connection information is provided on the TDD of the carried Truss, the Girder Truss or on a separate Truss-to-Truss Connection schedule.

## FASTENER GUIDELINES

- Fasteners typically specified for attaching together the individual plies of multi-ply Girder Trusses include nails, bolts or other approved fasteners, depending on the amount of Load and number of girder plies.
- Use the correct type and size of fastener(s) specified on the TDD.
- Locate and space fasteners in accordance with the requirements specified on the TDD.

## NAIL FASTENERS

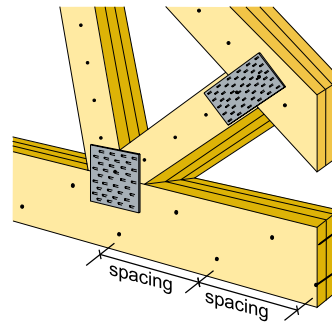


FIGURE B9-4

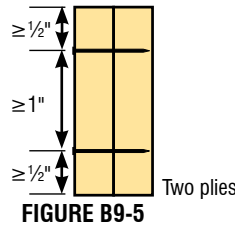


FIGURE B9-5

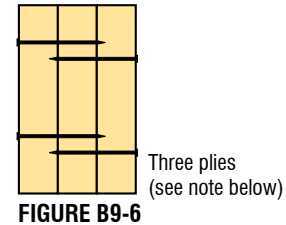


FIGURE B9-6

Girder Trusses of up to three (3) plies are permitted to be fastened together with nails. Nail each additional ply in accordance with the specified schedule found on the TDD.

**Note:** Multi-ply Girder Trusses that are fastened together with nails at the jobsite shall have the nail heads visible for inspection. This is not required if the multi-ply girder is fastened by the Truss Manufacturer at the manufacturing plant, as the in-plant QC program and third-party inspection process assures that the fastening is performed per the requirements of the TDD.

## SCREW FASTENERS

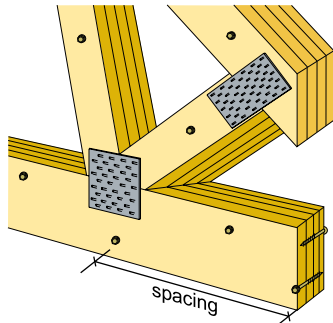


FIGURE B9-7

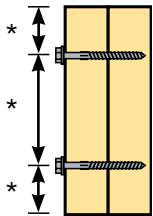


FIGURE B9-8

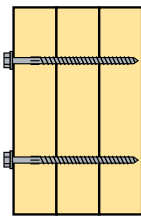


FIGURE B9-9

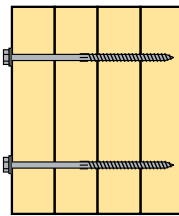


FIGURE B9-10

- ✓ Girder Trusses up to four (4) plies are permitted to be connected with specially designed high-strength screws. Install per screw manufacturer and Truss Designer requirements and specifications.

**NOTICE** Some screw manufacturers require the screws be installed with the screw heads in the **loaded** ply, or require a reduction in screw capacity if the screw heads are installed in the unloaded ply.

- ✓ Screw head locations shall not interfere with fastening of the hardware or framing members to be attached to the Girder Trusses.
- ✓ Pre-drilling holes for screw application is often required in structural composite lumber (SCL). See SCL and screw manufacturer's recommendations.
- ✓ Two-ply floor Trusses are permitted to be attached with screws per the TDD and screw manufacturer's recommendations.

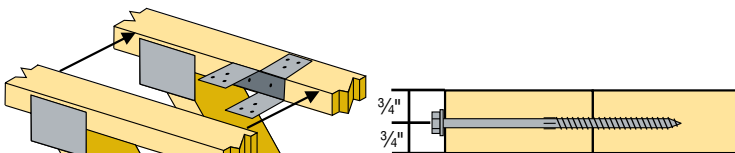


FIGURE B9-12

FIGURE B9-11

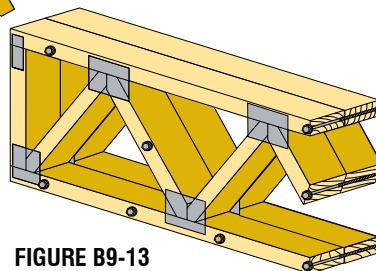


FIGURE B9-13

## BOLT FASTENERS

Install per bolt manufacturer and Truss Designer requirements and specifications.

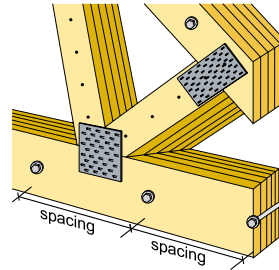


FIGURE B9-14

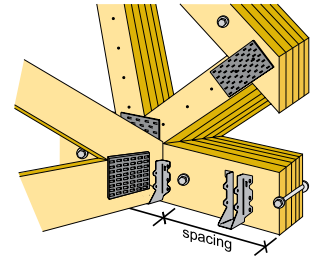


FIGURE B9-15

\*Varies. Refer to NDS and fastener manufacturer's requirements.

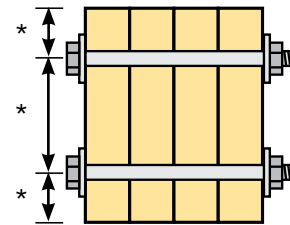


FIGURE B9-16

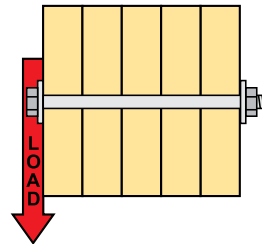


FIGURE B9-17

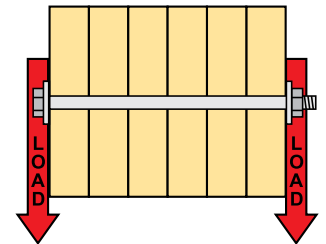


FIGURE B9-18

- ✓ Bolt locations shall not interfere with fastening of the hardware or framing members to be attached to the Girder Truss.
- ✓ Pre-drill all bolt holes. Do not oversize the hole! Use washers at bolt head and nut. Use nails as required.
  - Girder Trusses up to six (6) plies are permitted to be connected with bolts.
  - Maximum five (5) plies for Girder Trusses supporting Loads on one side.
  - Maximum six (6) plies for Girder Trusses supporting Loads on both sides.

**Notes:**

## POST FRAME TRUSS INSTALLATION, RESTRAINT & BRACING

### COMMENTARY AND RECOMMENDATIONS

For Trusses spaced greater than 2'-0" on-center and up to 81'-0" in length.



PHOTO B10-1

**⚠ WARNING** The erection of Trusses is inherently dangerous and requires, above all, careful planning and communication between the Contractor, crane operator and installation crew. Depending on the experience of the Contractor, it is strongly recommended that a meeting be held with all onsite individuals involved in the lifting/hoisting, installing and restraint/Bracing operations to review the provisions of:

- Construction Documents (i.e., architectural/structural ...plans and specifications)
- Truss Submittal Package, which includes:
  - Truss Design Drawings (TDD)
  - Truss Placement Diagram(s) (if/when required by Contract)
- BCSI book and/or B-Series Summary Sheets (when provided)
- erection and installation plan (if provided)
- site-specific conditions and issues
- OSHA jobsite lifting and fall protection requirements (see [BCSI-B11](#))

**⚠ DANGER** Disregarding handling, installing, restraining and Bracing safety recommendations is the major cause of Truss erection/installation accidents. Ignoring an unsafe condition or action will greatly increase the probability of an accident resulting in property damage, serious personal injury and/or death.

Proper Truss erection, installation, restraint and Bracing requires an understanding of Triangulation within and between the various planes of the Truss (i.e., Top Chord, Bottom Chord and Web). **It is critical to note that all Lateral Restraints must be braced. Lateral Restraint by itself is not adequate to resist the buckling forces in the members to which it is attached without the rigidity provided by Bracing.** This understanding is essential for a safe installation.

The Contractor shall be familiar with general Bracing concepts as discussed in the documents referenced above. It is not intended that these recommendations be interpreted as superior to the Building Designer's design specification for handling, installing, restraining and Bracing Trusses and it does not preclude the use of other equivalent methods for restraining/Bracing and providing stability for the walls, columns, floors, roof and all the interrelated Structural Building Components as may be determined by the Contractor. The Contractor is also responsible for the proper and safe lifting of the Trusses. See [BCSI-B1](#) for additional commentary on handling and installing Trusses. Every project has different site conditions that can have a specific affect on the erection process. Before the first Truss is erected, every individual on the erection crew, including the crane operator, needs to understand the installation plan and the intended Lateral Restraint and Diagonal Bracing requirements for a safe, efficient and accident-free jobsite.

**⊘ WHAT NOT TO DO:** Fail to Install Diagonal Bracing

**☑ Always Diagonally Brace for Safety!**



PHOTO B10-2

**⚠ DANGER** Long Span Trusses are extremely dangerous to install.

**Long Span Trusses, i.e., Trusses with clear spans 60' or greater, pose significant risk to installers.** The dimensions and weight of a Long Span Truss can create instability, buckling and collapse of the Truss if it is not handled, installed, restrained and braced properly. Long Span Trusses can be installed safely and efficiently, but they require more detailed safety and handling measures than shorter span Trusses. **Hire a Registered Design Professional** to provide a Temporary Restraint/Bracing plan and to supervise the erection process.

### CONSIDERATIONS BEFORE STARTING

Prior to starting the erection/installation process, there are several checks that are the responsibility of the Contractor. These include:

- ✓ 1. Is there a complete set of the Building Designer approved Construction Documents on the jobsite?
- ✓ 2. Is the Building the correct size? Are all as-built dimensions the same as those depicted in the Construction Documents? If not, corrective actions shall be taken prior to Truss installation.
- ✓ 3. Are the Load bearing supports (e.g., walls, columns, headers, beams, etc.) plumb and properly braced? Stopping in the middle of the Truss installation to straighten and brace these supports is dangerous. Having an inadequately braced support system buckle during the erection process will cause property damage, personal injury and/or death.
- ✓ 4. Are all bearing supports accurately installed at the locations shown on the Construction Documents? If not, corrective action shall be taken prior to Truss installation.
- ✓ 5. Are the tops of all bearing supports at the correct elevation? Uneven bearing surfaces are a major cause of Truss unevenness, and can cause costly delays and/or repairs. Check and correct bearing deficiencies prior to starting the Truss erection process.
- ✓ 6. Are the bearing supports straight along their length, and parallel where they should be parallel? If not, corrective action shall be taken prior to Truss installation.
- ✓ 7. Are the delivered Trusses the right size? Check Trusses for dimensions and damage as soon as they arrive on the site to avoid possible installation delays.
- ✓ 8. Are all required hangers, clips, tie-downs, and restraint/Bracing materials onsite and located where they will be readily accessible when needed? Obtain all materials or parts prior to starting the Truss erection process. Do not attempt to “make do” without all required materials. Jobsite safety has no room for shortcuts.
- ✓ 9. Is the jobsite clean and neat with scraps and trash from the construction process removed or in designated areas away from the work area? Truss erection typically involves bringing the Trusses in overhead with the assistance of a crane. Worker attention is often directed upward, even while moving around. A clean jobsite will help to avoid trips and falls.
- ✓ 10. Have the appropriate Ground Bracing techniques for the first Truss been determined? Steeply sloping site terrain or upper level Truss installations usually warrant using an Interior Ground Brace scheme, as Exterior Ground Brace Diagonals get exceedingly long and require substantial bracing themselves.
- ✓ 11. Is the Building configuration such that the first set of

Trusses can be stabilized by tying them off to the Building structure (existing or new) itself? Particular attention shall be paid to the adequacy of the wall Bracing if this technique is chosen.

- ✓ 12. Is the roof a hip style? For hip style roofs, use the crane to lift and hold the Girder Truss while the end jacks are installed to brace the Girder Truss. This eliminates the need for Ground Bracing the first Truss, assuming all hardware and hangers are properly installed prior to the crane releasing the Girder Truss. Properly attaching the Girder Truss and jack Trusses at their bearing points and permanently restraining and Diagonally Bracing this assembly will provide a rigid framework to which subsequent Trusses can be restrained and braced.

### GENERAL SAFETY REMINDERS

Before starting, here are some general safety reminders:

- 1. Brief all members of the erection/installation crew as to the installation plan and the intended Lateral Restraint and Diagonal Bracing requirements.
- 2. If possible, fasten together all multi-ply Trusses, including Girder Trusses, per the TDD prior to lifting into their assumed positions on the Building (see **BCSI-B9**).
- 3. **Check all Trusses for damage (see BCSI-B5) prior to, during and after the erection/installation process. Do not install damaged Trusses unless specifically instructed on how to do so by the Building Designer, Truss Designer or Truss Manufacturer.**
- 4. **NOTICE** Brace all rows of Lateral Restraint with Diagonal Bracing. Lateral Restraint alone is not adequate without the added rigidity of Triangulation provided by the Diagonal Bracing.
- 5. Property damage, bodily injury and/or death are possible when Trusses are improperly handled, installed, restrained and/or braced. Installation of Trusses can be dangerous, particularly Long Span Trusses (i.e. Trusses with clear spans of 60' or greater).



## TRUSS STORAGE

See **BCSI-B1** for additional information on Truss unloading, jobsite handling, jobsite storage, hoisting and lifting. Heed all warnings and caution notes.

- ⊘ **DO NOT** unload Trusses on rough terrain or uneven surfaces that could cause damage to the Truss.

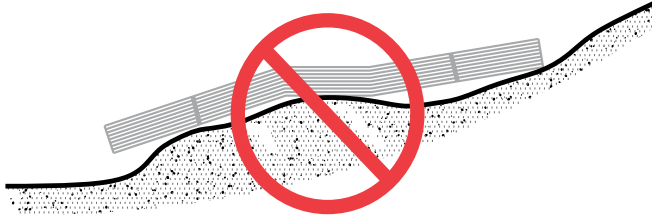


FIGURE B10-1

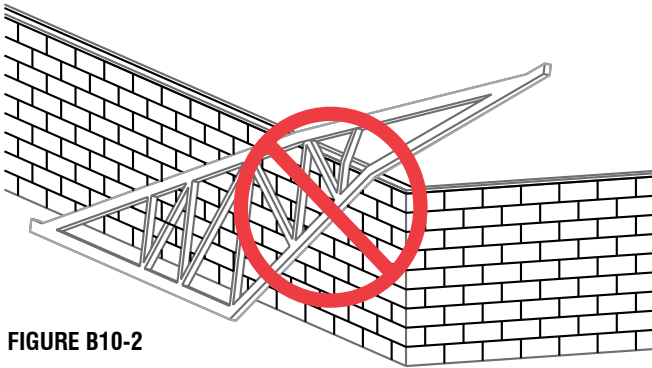


FIGURE B10-2

- ⊘ Walking on Trusses that are lying flat is extremely dangerous and shall be strictly prohibited.
- ✅ Trusses may be unloaded directly on the ground at the time of delivery or stored temporarily in contact with the ground after delivery. If Trusses are to be stored horizontally for more than one week, place blocking of sufficient height beneath the stack of Trusses on 8' to 10' intervals (or as required) to minimize lateral bending and to lessen moisture gain from the ground.

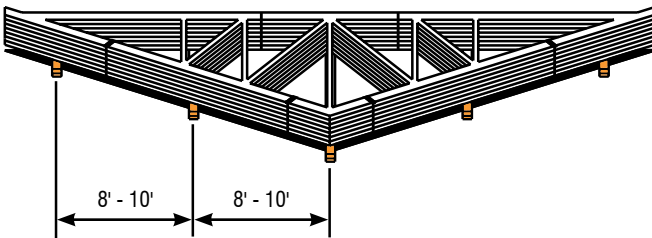


FIGURE B10-3

- ✅ Trusses stored for more than one week shall be protected from the environment in a manner that provides adequate ventilation of the Trusses. If tarpaulins or other protective covers are used, the ends must be left open for ventilation. Tight-fitting covers are not recommended, since they trap moisture.

- ⊘ **DO NOT** store bundles upright (vertical) unless properly braced to prevent toppling.

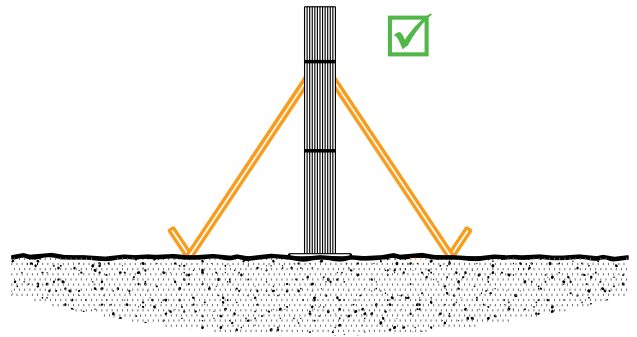


FIGURE B10-4

- ⊘ **DO NOT** break banding until bundles are placed in a stable horizontal position.
- ⊘ **DO NOT** break banding on Truss bundles until installation begins. Exercise care when removing banding to avoid shifting of individual Trusses.
- ⚠️ **CAUTION** Exercise care when removing banding and handling Trusses, to avoid damaging Trusses and prevent injury. Wear personal protective equipment for the eyes, feet, hands and head when working with Trusses.

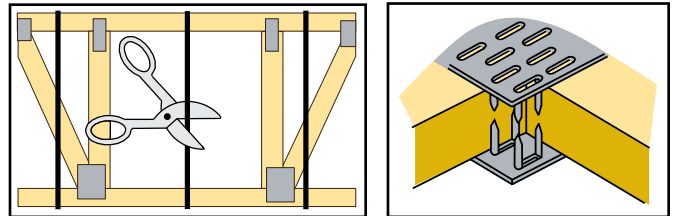


FIGURE B10-5

## MECHANICAL INSTALLATION

**WARNING** Buildings under construction are vulnerable to high winds and present a safety hazard. It is the responsibility of the erection/installation Contractor to recognize adverse weather conditions and take prompt and appropriate action to protect life and property.

**NOTICE** Do not lift bundled Trusses by the banding.

**CAUTION** Do not exceed header capacity when placing bundles of Trusses because this can result in overstressing of the header, post and/or header-to-post Connection.

**NOTICE** Do not attach cables, chains, or hooks to the web members.

**NOTICE** Using a single pick-point at the peak can damage the Truss.

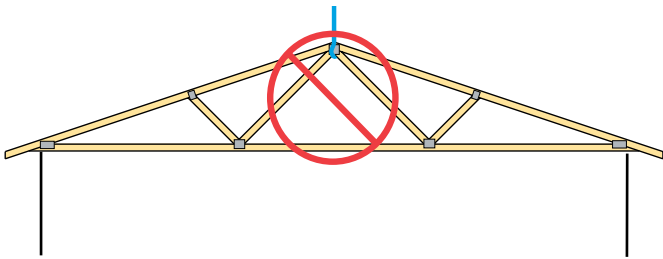


FIGURE B10-6

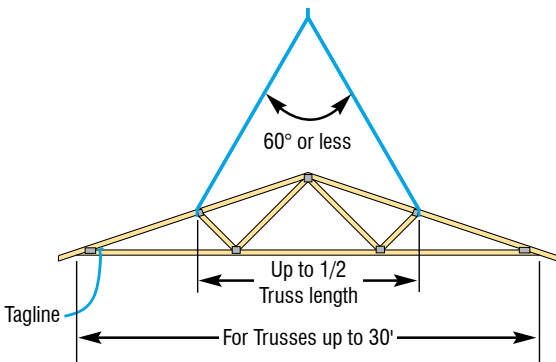


FIGURE B10-7

### TRUSSES UP TO 60'

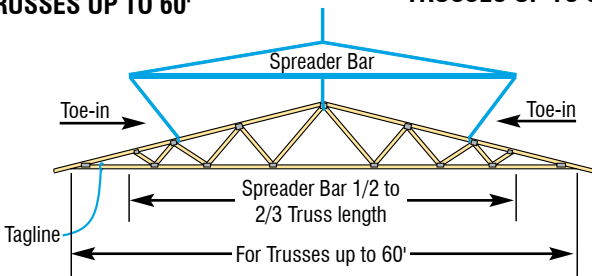


FIGURE B10-8

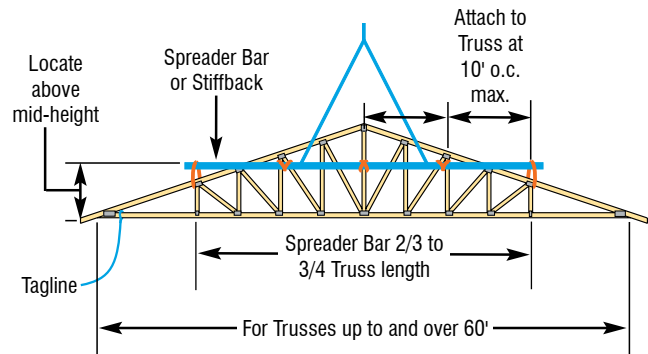


FIGURE B10-9

### TRUSSES UP TO AND OVER 60'

**NOTICE** Connect lifting devices to the Truss Top Chord (or stiffback as applicable) with a closed-loop attachment utilizing materials such as slings, chains, cables, or nylon strapping of sufficient strength to carry the weight of the Truss. Set each Truss in proper position per the Building Designer's framing plan and hold with the lifting device until the ends of the Truss are securely fastened and all Temporary Installation Restraint/Bracing is installed.

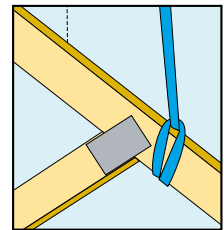


FIGURE B10-10

### IMPORTANT NOTES ON LIMITATIONS OF RECOMMENDATIONS

✓ The recommendations and guidelines presented in **BCSI-B10** are intended primarily for post frame buildings using Trusses with the following characteristics:

1. Trusses are used in an engineered building system.
2. Columns (laminated columns or posts) are embedded in the ground or attached to a foundation using the method specified by the Building Designer.
3. For gable-style roofs, the end walls shall have columns that extend to the Top Chord of the Gable End Truss with adequate contact between the Top Chord and column for a structural connection. The Gable End Trusses are stabilized against rollover by connecting the Top and Bottom Chords to the end wall columns or engineered Bracing system.
4. Side wall columns extend above the mid-height of the Truss heel at the Connection of the column and the Truss.
5. Truss heels are connected to columns or headers (i.e., beams, girders) to resist rollover at the heel.
6. Trusses have flat Bottom Chords and are spaced 4' to 12' on-center (o.c.).
7. Purlins are attached directly to the Top Chord.

**NOTICE** The information presented in **BCSI-B10** that is specific to Truss handling, installation, restraint and Bracing is applicable to Truss applications in which the Trusses are spaced >2' to 12' on-center.

## TEMPORARY INSTALLATION RESTRAINT/BRACING PRINCIPLES

Use the following chronological steps to provide Temporary Installation Restraint/Bracing for Truss installation.

**WARNING** Until the Building is completely erected in accordance with the Construction Documents, the Trusses are unstable and can present a safety hazard. Truss instability increases with increasing Building width, height and length.

### STEP 1. ENSURE STABLE SIDE WALL AND END WALL COLUMNS:

- 1.1 a) Embedded columns shall be backfilled with concrete or compacted fill.
- b) Columns bearing on a concrete foundation shall be attached to prevent horizontal movement of column base as specified by the Building Designer in the Construction Documents (Figure B10-11).

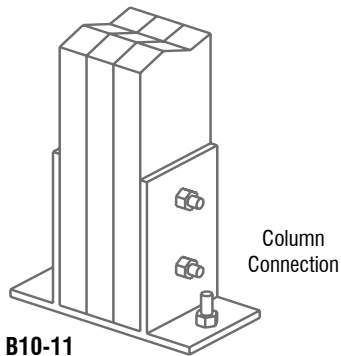


FIGURE B10-11

- 1.2 Attach girts, splash board or Temporary Lateral Restraint and install a system of Temporary Diagonal Ground Bracing to provide support in the plane of the wall (Figure B10-12) and perpendicular to it (Figure B10-13).

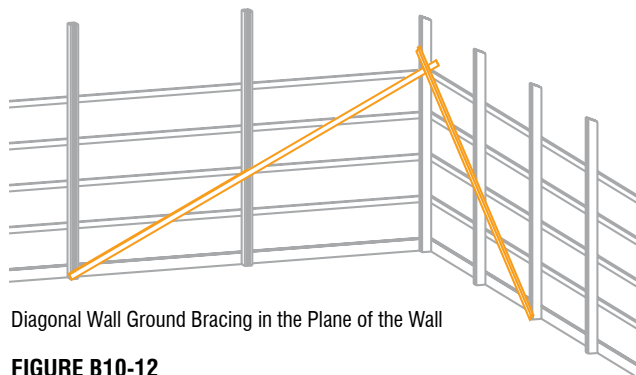
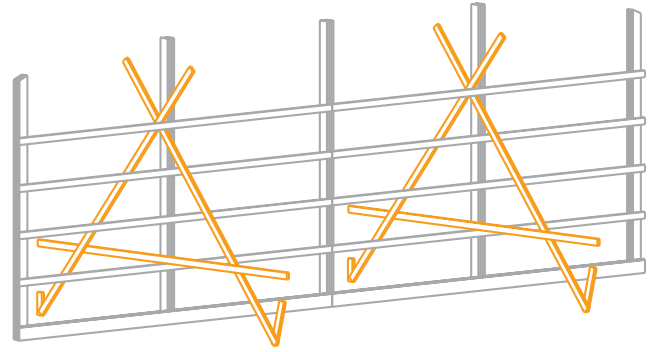


FIGURE B10-12



A-Frame Ground Bracing Perpendicular to the Wall

FIGURE B10-13

### STEP 2. PROVIDE A STABLE BASE UNIT UPON WHICH TO BUILD:

- 2.1 Install Trusses on side wall columns and header system in sufficient quantities (usually 16' - 24' of side wall) to establish a stable base unit. See Sections 3.1, 3.2 and 3.3 for restraint/Bracing requirements.
- 2.2 Resist movement of the base unit parallel to the end wall with,
  - a) Diagonal Braces (Figure B10-14)

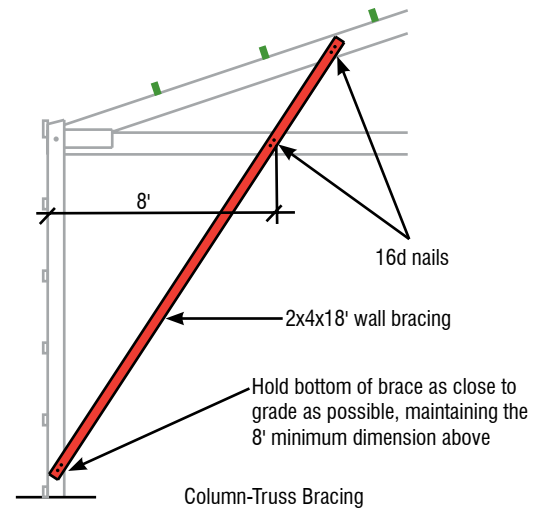
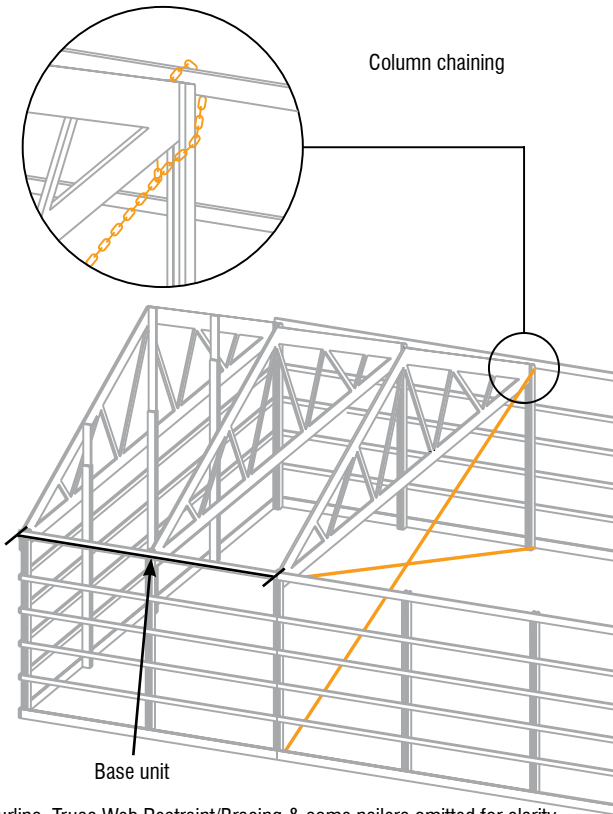


FIGURE B10-14

# BCSI-B10: Post Frame Truss Installation, Restraint & Bracing



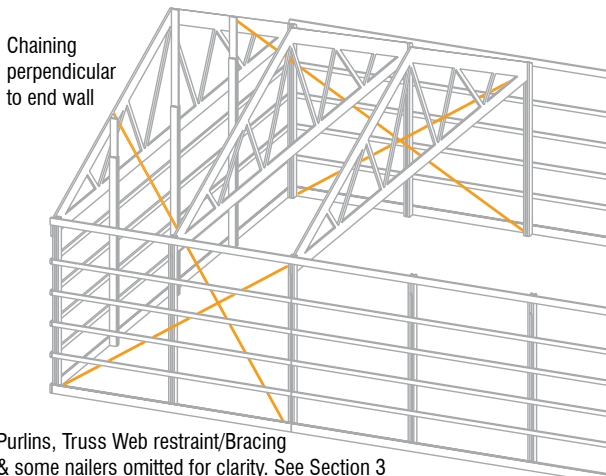
Purlins, Truss Web Restraint/Bracing & some nailers omitted for clarity. See Step 3 for Temporary Restraint & Bracing requirements for the Trusses.

**FIGURE B10-15**

b) Chains or cables (Figure B10-15) together with turn-buckles, or come-alongs of sufficient strength (min. 2,000 lbs capacity)

2.3 Use one or more of the following methods to resist movement of the base unit perpendicular to the end wall:

- a) Temporary Diagonal Ground Bracing (Figures B10-12 and B10-13, page 77)
- b) Chains or cables (Figure B10-16) together with turn-buckles, or come-alongs of sufficient strength (min. 2,000 lbs capacity)



Purlins, Truss Web restraint/Bracing & some nailers omitted for clarity. See Section 3 for Temporary Restraint & Bracing requirements for the Trusses.

**FIGURE B10-16**

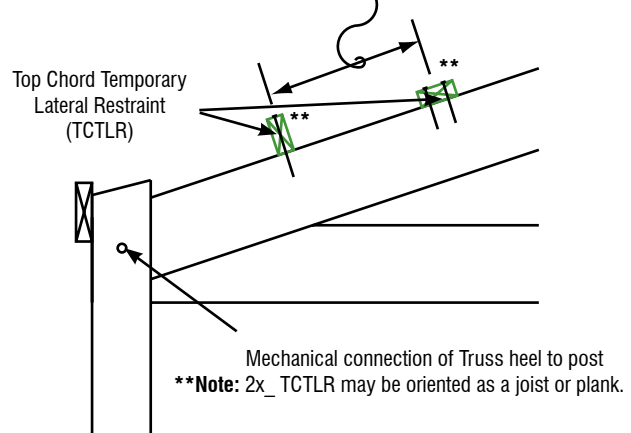
**NOTICE** The Ground Bracing concepts provided in **BCSI-B2** can also be used with roof Trusses spaced greater than 2' on-center.

2.4 Stable base unit is now ready to begin Truss installation.

## STEP 3. TEMPORARY RESTRAINT/BRACING OF THE TRUSS BASE UNIT

3.1 Provide a mechanical Connection to resist Truss rollover at the heel (Figure B10-17). This includes the use of nails, bolts, lag screws, metal straps, or Connectors.

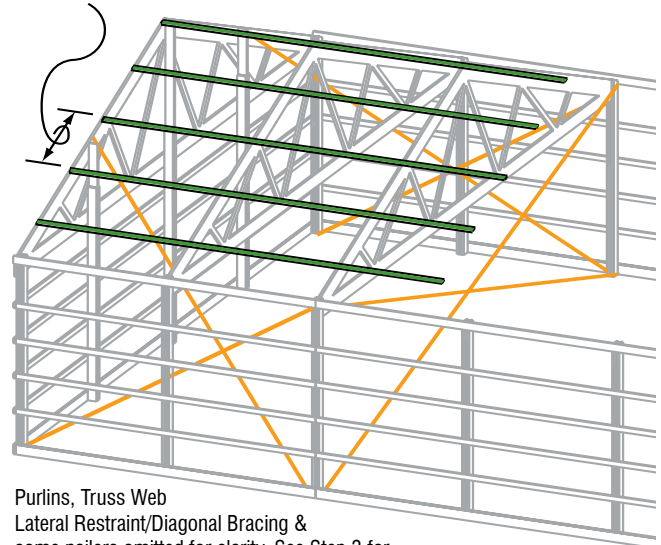
10', 8' or 6' spacing per Table B10-1



**FIGURE B10-17**

3.2 Install Top Chord Temporary Lateral Restraint (TCTLR) as indicated in Table B10-1 and shown in Figures B10-17 and 18.

10', 8' or 6' spacing per Table B10-1, page 79



Purlins, Truss Web Lateral Restraint/Diagonal Bracing & some nailers omitted for clarity. See Step 3 for Restraint/Bracing requirements.

**FIGURE B10-18**

**IMPORTANT NOTE:** Use a minimum of 2-16d (0.135x3.5") nails or equivalent for Temporary Restraint and Bracing Connections, unless otherwise specified by the Building Designer.

**TOP CHORD TEMPORARY LATERAL RESTRAINT SCHEDULE**

Maximum Truss Spans for chord size, grade and spacing between rows of Lateral Restraint.

Top Chord Size	Top Chord Grades (or Better)								
	No 1 Southern Pine			MSR 1950f 1.5E			MSR 2400f 1.8E		
	Maximum Spacing Between Rows of Lateral Restraint								
	10'	8'	6'	10'	8'	6'	10'	8'	6'
2x6	n/a	n/a	62'	n/a	25'	81'	n/a	42'	81'
2x8	n/a	27'	81'	n/a	43'	81'	22'	61'	81'
2x10	n/a	40'	81'	24'	57'	81'	35'	78'	81'
2x12	21'	53'	81'	34'	74'	81'	48'	81'	81'

TABLE B10-1

**IMPORTANT NOTE:** Table B10-1 is applicable for symmetrical triangular Metal Plate Connected Wood Trusses with pitched Top Chords of 3:12 or greater and flat Bottom Chords. Other Truss types are expressly excluded. Truss spans listed in Table 1 are the maximum spans that can be safely restrained for the corresponding Top Chord species/grade/size shown, using the Top Chord Temporary Lateral Restraint spacing provided. FOR TRUSS CONFIGURATIONS, SPANS AND/OR TOP CHORD GRADES NOT COVERED BY TABLE B10-1, CONSULT A REGISTERED DESIGN PROFESSIONAL.

The Top Chord Temporary Lateral Restraint spacing schedules in Table B10-1 were developed for an assumed Load consisting of the weight of the Truss, plus two 250 lb workers (including their equipment). These schedules do not provide for wind Loads or for accidental overload, materials stacked on Trusses during erection, or Loads resulting from misuse or negligence.

3.3 Install diagonal bracing in the top chord plane using,

- Diagonal bracing with 2x4 lumber, minimum grade of SPF #2 (Figure B10-20)
- Metal strap cross bracing (Figure B10-21, page 80)
- Permanent Structural Sheathing (e.g., plywood, OSB, corrugated aluminum) or permanent roof Bracing in accordance with the product manufacturer's instructions or Construction Documents

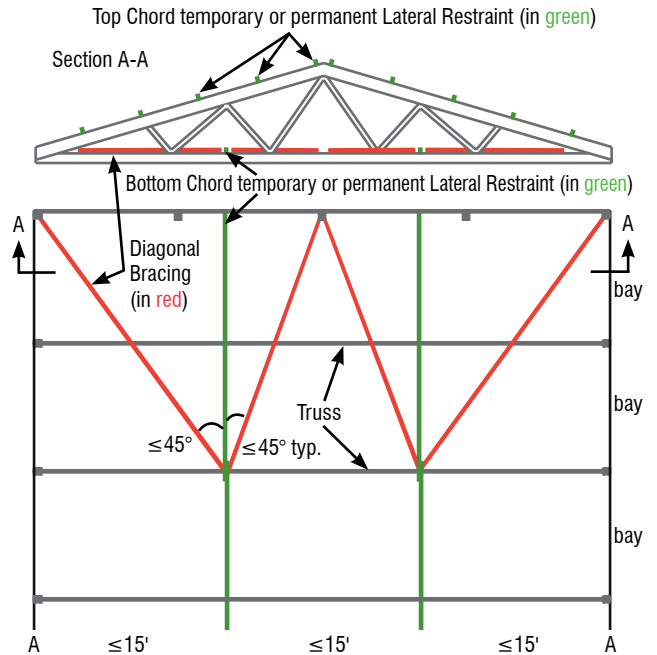
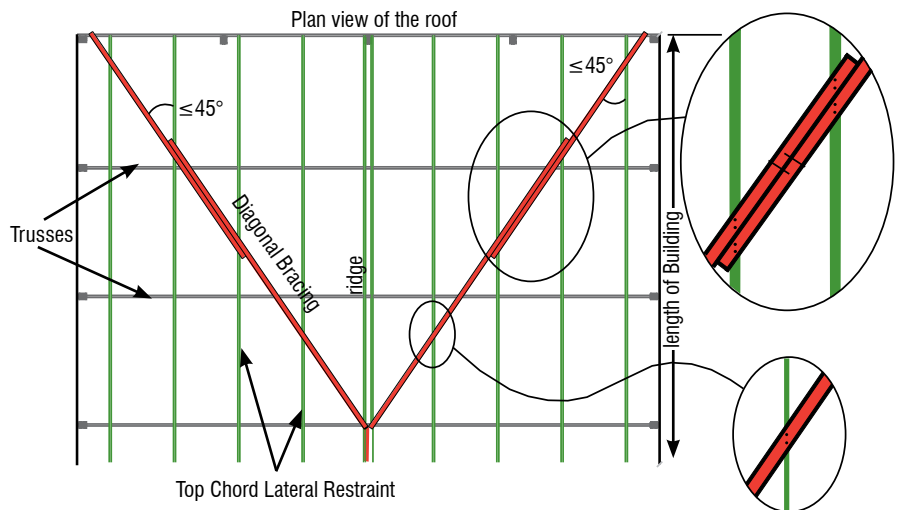


FIGURE B10-19 Bottom Chord Restraint and Bracing

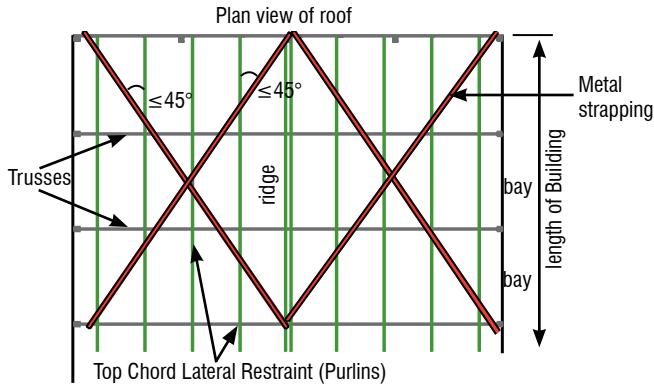
3.4 Install rows of Bottom Chord Temporary Lateral Restraint (BCTLR) at a maximum of 15' on-center. Install Diagonal Bracing to top of Bottom Chord between each row of Lateral Restraint to provide rigidity (Figure B10-19). **Note:** Bottom Chord **PERMANENT** Lateral Restraint shall be installed at no more than 10' on-center, but may be less if required by the specific Truss design and/or the Building Designer. Temporary Lateral Restraint and Diagonal Bracing installed at the required spacing for the Permanent Building Stability Bracing (PBSB), and left in place, may become part of the PBSB system.



**Note:** Diagonal Braces run to the fourth Truss on 48' & wider buildings. Braces lap two rows of Lateral Restraint if Diagonal Brace is spliced. Use 2-16d (0.135x3.5") nails at each Diagonal Brace-to-purlin Connection.

FIGURE B10-20 Top Chord Diagonal Bracing using 2x4 Lumber

# BCSI-B10: Post Frame Truss Installation, Restraint & Bracing

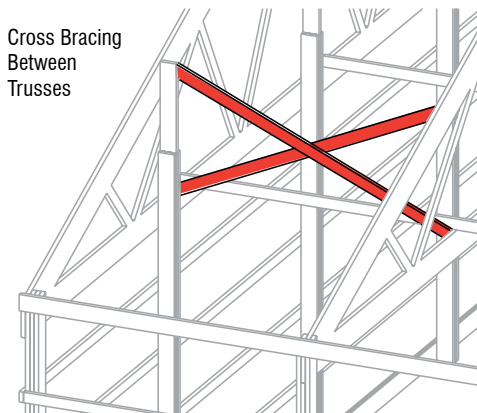


**Note:** Metal strap cross Bracing is typically used when Purlins are mounted flush between Trusses. Run Bracing to the fourth Truss on 48' and wider buildings.

**FIGURE B10-21** Bracing of Top Chords using Metal Strap Cross Bracing

3.5 Brace Trusses vertically to prevent “rollover,” (i.e., rotation) using:

- Truss-to-Truss cross Bracing at each row of Bottom Chord Lateral Restraint and at 20' intervals along the length of the building (Figure B10-22) unless 3.3 (c) on page 79 is applied to all Trusses as they are being set
- Chains or cables (Figure B10-16, on page 78) together with turnbuckles, or come-alongs of sufficient strength (min. 2,000 lbs capacity)



**FIGURE B10-22**

## STEP 4. ERECT THE ADDITIONAL ROOF TRUSSES

- Install TCTLR at the appropriate spacing indicated in Table B10-1, on page 79.
- Provide additional top chord temporary diagonal bracing described in Step 3.3 (page 79) at intervals not to exceed 100' or 12 Truss spaces, whichever is less.
- Install BCTLR as indicated in Figure B10-19, on page 79. Provide additional temporary Diagonal Bracing in the plane of the Bottom Chord as indicated in Figure B10-19, on page 79, at intervals not to exceed 100' or 12 Truss Spaces, whichever is less.

## PERMANENT RESTRAINT/BRACING

**⚠ WARNING** Disregarding Permanent Individual Truss Member Restraint and Permanent Building Stability Bracing recommendations is a major cause of Truss field performance problems and has been known to lead to collapsed roof and/or floor systems. Failure to install the proper restraint and Bracing will greatly increase the probability of Truss performance problems or an accident resulting in property damage, personal injury or death.

Trusses, as with other types of structural framing components such as joists, beams, studs, etc., require lateral support in order to perform in the manner for which they are intended. Trusses are designed to carry Loads applied within their plane. Trusses are not designed to resist lateral (i.e., out-of-plane) Loads and rely on PBSB to transfer the lateral Loads out of the Truss System into the supporting structure. Certain individual Truss members also require Lateral Restraint and Bracing to prevent buckling under the applied design Loads. Permanent Bracing provides sufficient support at right angles to the plane of the Truss to hold every Truss member in the position assumed for it in the design. Permanent Lateral Restraint and Bracing is needed for the proper performance of individual Trusses within the roof or floor system.

## USING TEMPORARY RESTRAINT/BRACING AS PERMANENT RESTRAINT/BRACING

The previous sections of **BCSI-B10** provide important information and guidelines on Temporary Installation Restraint/Bracing of Trusses. Many elements of Temporary Restraint/Bracing of Trusses also apply to Permanent restraint/Bracing of Trusses. Temporary Restraint/Bracing of Trusses provides support to the Trusses during installation. Permanent Restraint/Bracing of Trusses provides support to the Trusses during the lifetime of the structure and resists the applied Loads anticipated during that lifetime. If properly planned, most if not all of the Temporary Restraint/Bracing installed during Truss installation can be used to permanently restrain and brace the Truss.

## RESTRAINT/BRACING MATERIALS & FASTENERS

- ✓ The material and fasteners used to restrain and brace Trusses shall be of sufficient strength and stiffness to hold every Truss member in the position assumed for it in the design.

Minimum Lumber Restraint/Bracing <sup>1</sup>			
Truss on-center Spacing	Lumber Grade	Lateral Restraint Type	Diagonal Bracing Type
$\leq 4'$	SPF No. 2	2x4	2x4
$4 < \text{spacing} \leq 6'$		2x4	2x4 with 2x4 L-Reinforcement <sup>2</sup>
$6 < \text{spacing} \leq 8'$		2x4 with 2x4 L-Reinforcement <sup>2</sup>	2x4 with 2x4 L-Reinforcement <sup>2</sup>
$8 < \text{spacing} \leq 12'$		2x4 with 2x4 L-Reinforcement <sup>2</sup>	2x6 with 2x6 L-Reinforcement <sup>2</sup>

<sup>1</sup>Other Restraint/Bracing requirements may be specified by the Building Designer.

<sup>2</sup>Attach Reinforcement to the full length of the Lateral Restraint and Diagonal Bracing with 16d (0.131x3.5") nails @ 6" on-center.

- Use at least 2-16d (0.135 x 3.5") nails to attach lumber Lateral Restraint and Diagonal Bracing members at each Connection or as specified by the Building Designer. For 2x6 or greater Lateral Restraint and Diagonal Bracing, use a minimum of three nails per Connection.

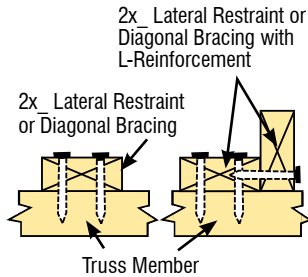


FIGURE B10-23

## PERMANENT BRACING FOR THE VARIOUS PLANES OF A ROOF TRUSS

Permanent Bracing applied at right angles to the plane (i.e., depth) of a Truss performs several functions including:

- Preventing out-of-plane buckling of certain Truss members due to compression forces developed under the specified design load conditions
- Maintaining the proper Truss Spacing
- Resisting and transferring the lateral Loads applied to the Truss System (e.g., wind, seismic, etc.)

Trusses are designed to only support Loads applied within their plane. Because Trusses are relatively narrow in relation to their depth and span, they require lateral support. Without this support, the entire Truss, or a portion of its members, will buckle (i.e., fail) at Loads far less than the design Loads that they were intended to carry.

Trusses require Permanent Bracing within ALL of the following planes:

- Top Chord Plane
- Bottom Chord Plane
- Web Member Plane

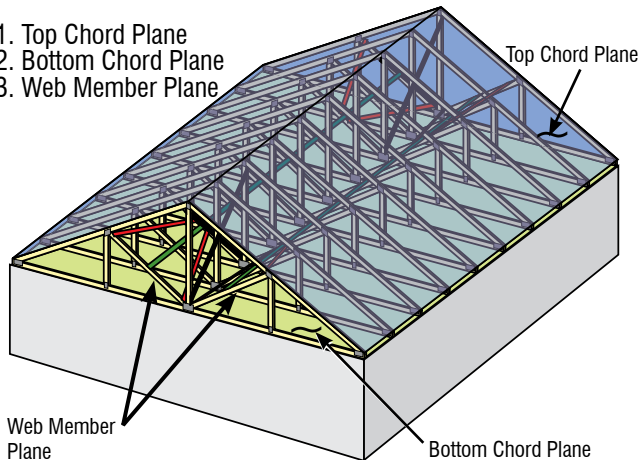


FIGURE B10-24

### 1. PERMANENT BRACING FOR THE TOP CHORD PLANE

- ✓ Permanent Bracing for the Top Chords of Trusses is typically provided by attaching Structural Sheathing, or wood or metal structural Purlins that are properly braced.
- ✓ The most common types of Structural Sheathing are wood structural panels such as plywood or oriented strand board (OSB).

- ✓ The wood structural panels shall have the appropriate span rating and/or grade to support the Building Designer's specified Loads at the on-center (o.c.) spacing of the Trusses.
- ✓ The sheathing and attachment requirements (i.e., fastener size and spacing) are provided on the Construction Documents prepared by the Building Designer and/or within the Building code.

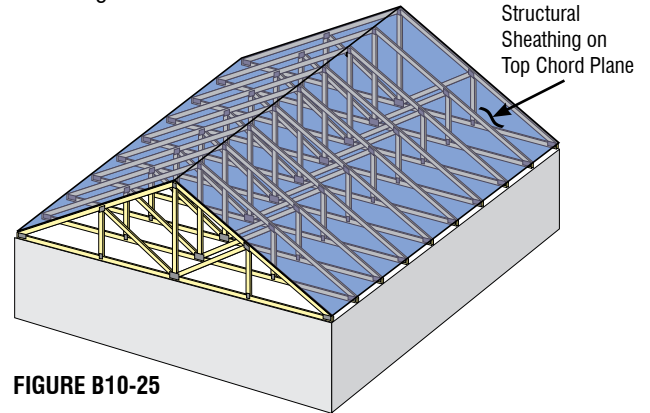
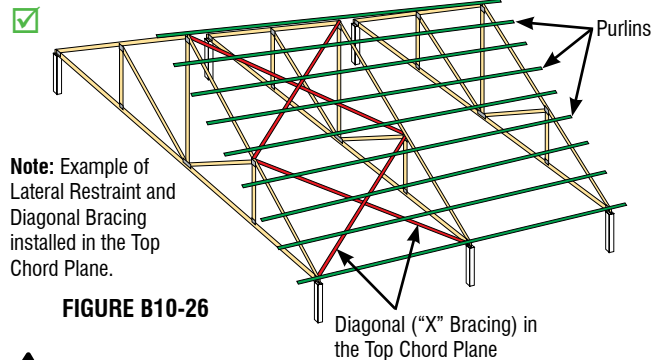


FIGURE B10-25

- ✓ Wood or metal Purlins are most often used in applications where Trusses are spaced greater than 4' o.c. The Purlins must be properly sized and fastened to the Top Chord of the Trusses in accordance with the specifications found in the Construction Documents. The Trusses must be designed so that the maximum allowable unbraced length for the Top Chord is greater than or equal to the on-center spacing of the Purlins. Check the TDDs to verify. Notify the Truss manufacturer immediately if this is not the case.



**Note:** Example of Lateral Restraint and Diagonal Bracing installed in the Top Chord Plane.

FIGURE B10-26

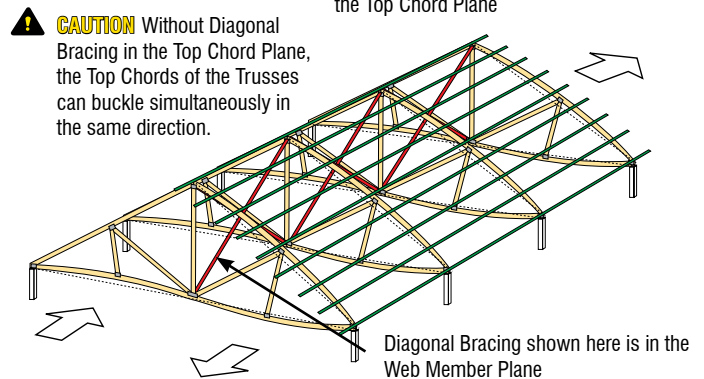


FIGURE B10-27

**Note:** The Purlins alone will not adequately brace or prevent buckling of the Top Chord and must themselves be braced.

This bracing can be provided in a number of ways including:

- Installing Diagonal Bracing to the Top Chord plane at intervals along the length of the Building to provide rigidity and to transfer the restraining forces from the Purlins to a lateral force resisting system (e.g., braced wall panels, shearwalls, braced frames, etc.)
- Attaching Structural Sheathing directly to the Purlins

**NOTICE** Not all sheathing products are structural. The Building Designer is responsible for the design and detailing of the Structural Sheathing and Diaphragms.

**CAUTION** Without some form of Permanent Diagonal Bracing, the Purlins, by themselves, only ensure that the Top Chords of the Trusses will all buckle in the same direction.

- ✓ The Building Designer is responsible for the design and detailing of the Purlins and the PBSB for the roof system.
- ✓ The TDD provides information on the assumed support for the Top Chord based on the Load conditions for which the Truss has been designed. This typically includes directly applied Structural Sheathing or Purlins at a specified maximum o.c. spacing.

## 2. PERMANENT BRACING FOR THE BOTTOM CHORD PLANE

- ✓ Permanent Bracing for the Bottom Chords of Trusses is typically provided by attaching either a rigid ceiling or Continuous lumber Lateral Restraint properly braced against lateral movement.

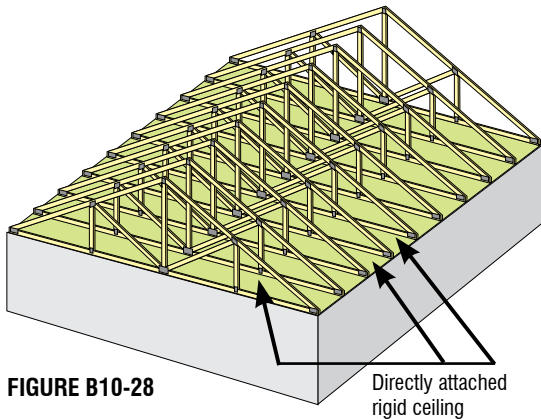


FIGURE B10-28

- ✓ Bottom Chord Permanent Lateral Restraint shall be installed at the spacing indicated on the TDD and/or by the Building Designer with a maximum of 10' on-center.
- ✓ The TDD provides information on the assumed support for the Bottom Chord based on the Load conditions for which the Truss has been designed. This typically includes a directly applied rigid ceiling or rows of Lateral Restraint at a specified maximum on-center spacing.
- ✓ Install rows of Diagonal Bracing at intervals of no more than 20' along the length of the Building, or as specified by the Building Designer, to provide stability and transfer the

forces from the Lateral Restraint to a lateral force resisting system.

**NOTICE** Reinforce Lateral Restraint and Diagonal Bracing as required for Truss spacings greater than 4' o.c. Refer to Table B10-2 on page 80 or as specified by the Building Designer.

## 3. PERMANENT BRACING FOR THE WEB MEMBER PLANE

- ✓ Permanent Bracing is typically installed in the Web Member Plane of a Truss to collect and transfer forces produced by the restraint of members subject to buckling and/or to transfer lateral Loads from wind and seismic forces applied to the Truss System. The same Bracing can often be used to support both functions. This Bracing is referred to as permanent stability Bracing and is the responsibility of the Building Designer.

### Individual Web Member Permanent Restraint & Diagonal Bracing

- ✓ Certain Web members require restraint and Diagonal Bracing against out-of-plane buckling in order to resist their intended forces.
- ✓ Web member restraint is typically accomplished by either reducing the unsupported length of the Web member via Lateral Restraint or by reinforcing the member with additional material and thus increasing its cross-section (i.e., Reinforcement).
- ✓ The TDD indicates which Web members (if any) require this restraint.

### Diagonal Bracing & Continuous Lateral Restraint

- ✓ If individual Web member Permanent Lateral Restraint is required on a particular Truss design, Continuous Lateral Restraint (CLR), consisting of 2x\_ SPF No. 2 or better dimension lumber attached at right angles to the Web in combination with Diagonal Bracing, is most frequently used.
- ✓ Webs may require one or two rows of CLR.
- ✓ The TDD will specify the number of rows and approximate location of the CLR.

**NOTICE** CLR's can be installed on either side of the member.

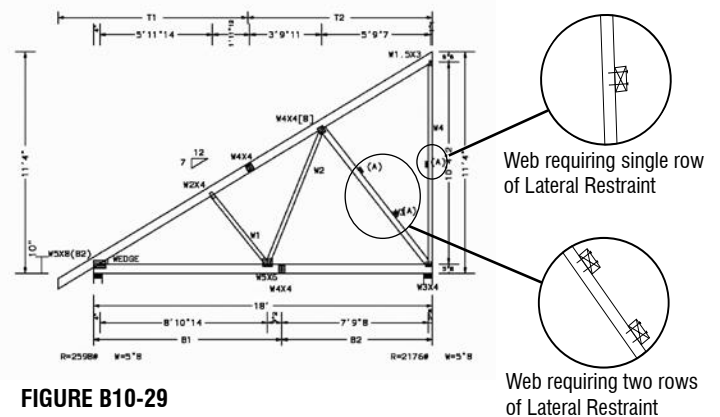


FIGURE B10-29



# BCSI-B10: Post Frame Truss Installation, Restraint & Bracing

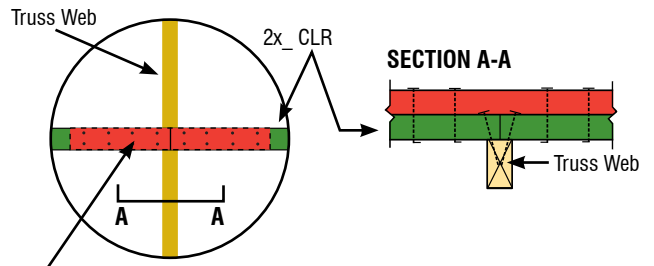
**Important Note:** CLR's shall always be Diagonally Braced for rigidity.

- ✓ Diagonal Bracing with CLR's work most efficiently when applied to three or more similar Trusses.
- ✓ Attach the Lateral Restraint at the locations shown on the TDD together with a Diagonal Brace at an angle of less than or equal to 45° to the Lateral Restraint (see Figures B10-32 and 33). Position the Diagonal Brace so that it crosses the Web in close proximity to the Lateral Restraint. The Diagonal Bracing should be attached as close to the Top and Bottom Chord plane as possible and to each Web that it crosses. This provides rigidity that prevents the Webs from displacing laterally.

**NOTICE** Reinforce Lateral Restraint and Diagonal Bracing as required for Truss spacings greater than 4' o.c. Refer to Table B10-2 on page 80 or as specified by the Building Designer.

- ✓ Diagonal Bracing is required to restrain the CLR(s) and to transfer the cumulative force from the CLR(s) into a lateral force resisting system such as the roof or Ceiling Diaphragm. **Repeat diagonal bracing every 16' or as specified by the Building Designer.**

### CLR splice reinforcement



Minimum 2' 2x\_Scabb block centered over Web/CLR splice. Attach to CLR with minimum 8-16d (0.135x3.5") nails each side of web/CLR splice or as specified by the Building Designer

**Always Diagonally Brace the Permanent Continuous Lateral Restraint!**

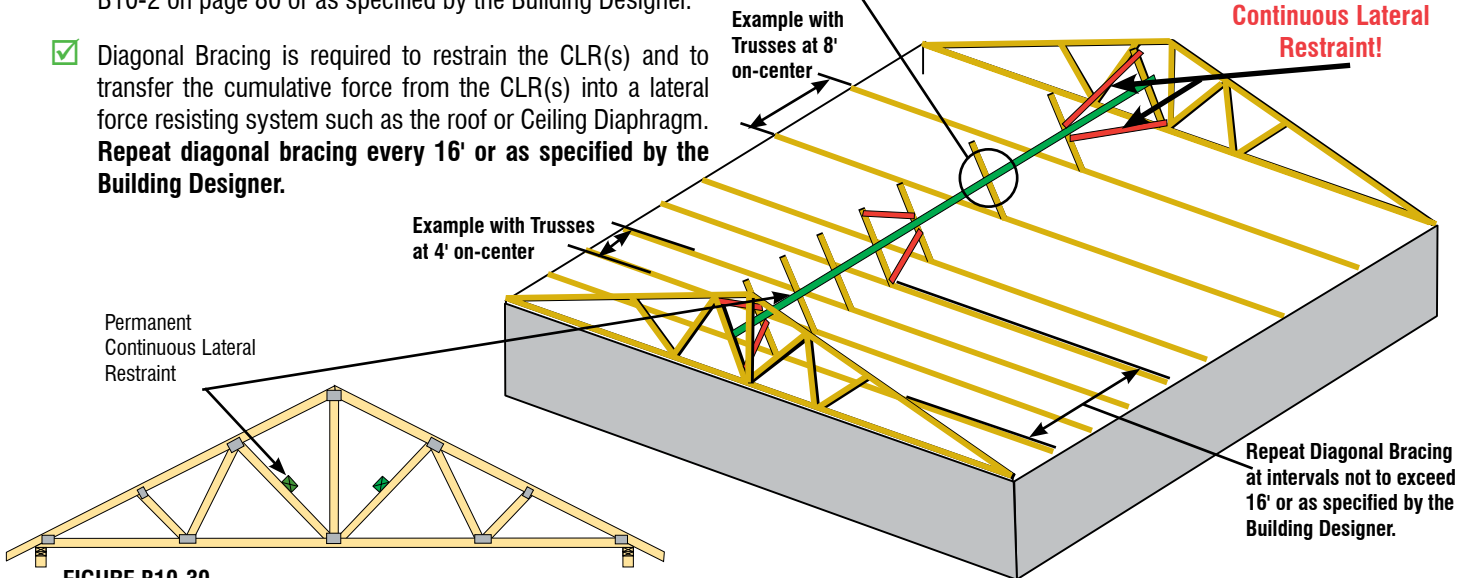


FIGURE B10-30

FIGURE B10-31

Note: Some chord and web members not shown for clarity.

### EXAMPLES OF DIAGONAL BRACING WITH ONE ROW OF CONTINUOUS LATERAL RESTRAINT

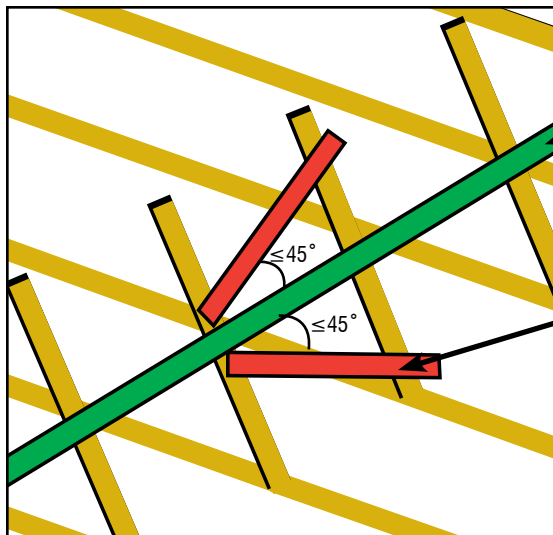


FIGURE B10-32

Continuous Lateral Restraint\*

Diagonal Bracing\*

\*Note: Splice reinforcement of CLR and Diagonal Bracing similar to that shown in Figure B10-31 as required.

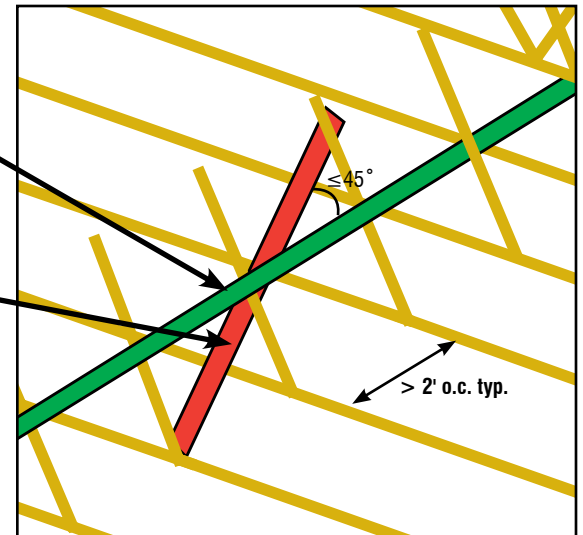


FIGURE B10-33

# BCSI-B10: Post Frame Truss Installation, Restraint & Bracing

✓ For Webs that require two rows of CLR, the concepts are the same as those used to brace a single row of CLR (see Figure B10-34 and B10-35 for examples). Position the Diagonal Brace(s) to cross the Webs in close proximity to each row of Lateral Restraint to minimize the out-of-plane bending forces in the Web. Attach the Diagonal Brace(s) as close as possible to the Top and Bottom Chord Plane and to each Web that the Diagonal Brace(es) crosses.

**NOTICE** Reinforce Lateral Restraint and Diagonal Bracing as required for Truss Spacings greater than 4' o.c. Refer to Table B10-2 on page 80 or as specified by the Building Designer.

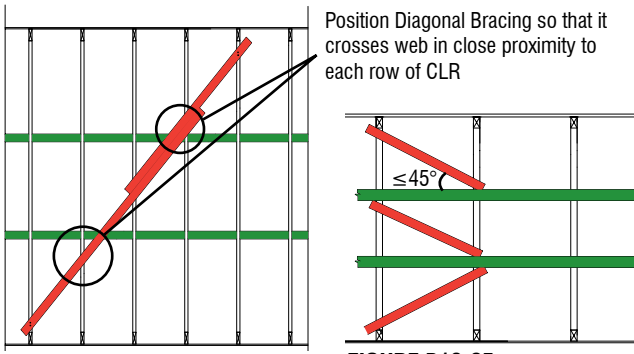


FIGURE B10-34

FIGURE B10-35

**Note:** Splice reinforcement, similar to that shown in Figure B10-31 on page 83, may also be used with Diagonal Bracing in lieu of overlap shown here.

### Individual Web Reinforcement (Jobsite Applied)

As stated in Section 2303.4.1.2 of the 2012 IBC (see also Chapter 2 of ANSI/TPI 1), one Truss member permanent bracing option includes: "Trusses shall be designed so that the buckling of any individual Truss member is resisted internally by the individual Truss through suitable means (i.e., buckling reinforcement by T-reinforcement or L-reinforcement, proprietary reinforcement, etc). The buckling reinforcement of individual members of the Trusses shall be installed as shown on the Truss Design Drawing or on supplemental Truss member buckling reinforcement details provided by the Truss Designer."

This individual member buckling reinforcement is installed by the Contractor.

✓ T-, L-, Scab, I- or U-Reinforcement are five options that involve adding lumber to increase the web's section properties, thereby increasing its resistance to buckling. Proprietary metal reinforcement products and stacked web products are also viable alternatives. This type of reinforcement is typically used as an alternative to the combination of continuous lateral restraint (CLR) and diagonal bracing when CLR is not possible or desirable.

✓ T-Reinforcement is commonly used and creates a "T" shape when applied to the web member.

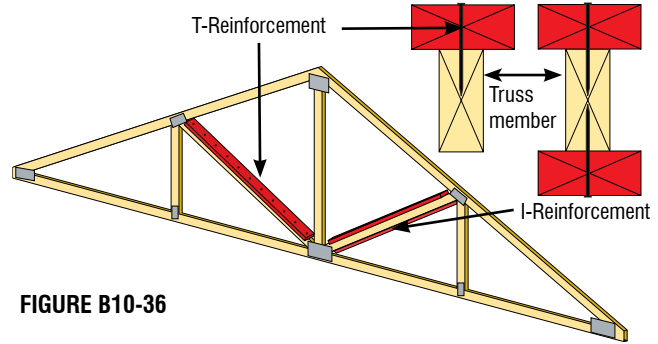


FIGURE B10-36

✓ L-reinforcement is similar to T-Reinforcement, but it creates a flat surface on one face of the Truss to permit the direct application of sheathing material.

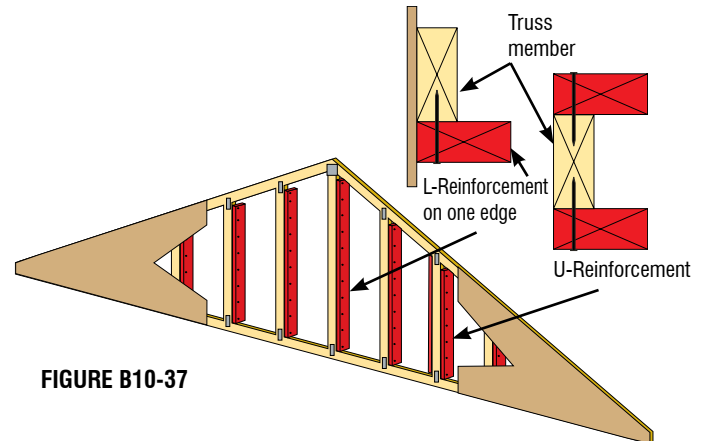


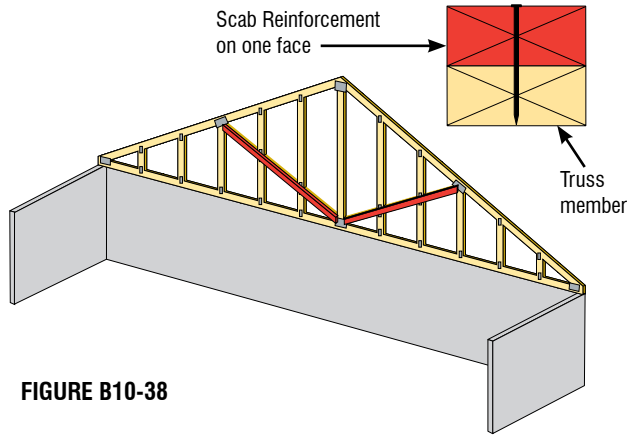
FIGURE B10-37

WEB REINFORCEMENT FOR SINGLE-PLY TRUSSES <sup>1</sup>								
Specified CLR	Size of Truss Web	Type & Size of Web Reinforcement				Grade of Web Reinforcement	Minimum Length of Web Reinforcement	Minimum Connection of Web Reinforcement to Web
		T	L	Scab <sup>2</sup>	I			
1 Row	2x4	2x4	2x4	2x4		Same species and grade or better than web member	90% of Web or extend to within 6" of end of web member, whichever is greater	16d (0.131x3.5") nails @ 6" on-center <sup>2</sup>
	2x6	2x6	2x6	2x6				
	2x8	2x8	2x8	2x8				
2 Rows	2x4	---	---	---	2-2x4			
	2x6	---	---	---	2-2x6			
	2x8	---	---	---	2-2x8			

<sup>1</sup>Maximum web length is 14'.

<sup>2</sup>Attach Scab Reinforcement to web with two rows of minimum 10d (0.120x3") nails at 6" on-center

TABLE B10-3

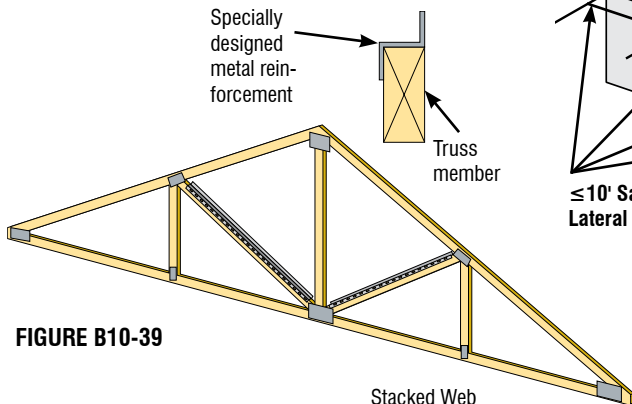


**FIGURE B10-38**

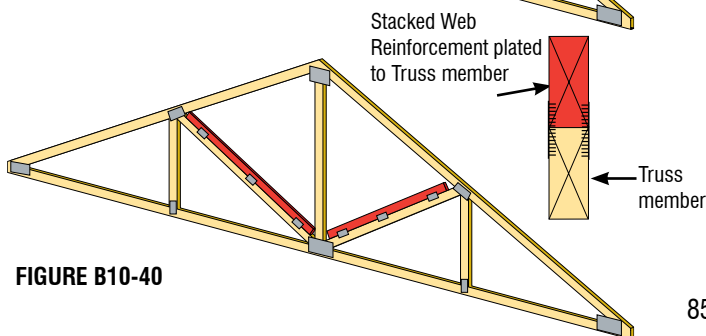
- ✓ Scab Reinforcement is installed on one face of the Web. It is often more structurally efficient for multiple-ply Webs and provides easier nailing because it is applied to a wide-face of the Web.
- ✓ I- and U-reinforcement are similar to T- and L-reinforcement, respectively, except that two (2) pieces of lumber are added, one to each narrow face of the Web. See Figures B10-36 and B10-37, respectively.
- ✓ The size, grade and species of the Web Reinforcement material, as well as the nailing schedule for attaching the reinforcement to the Web, is typically specified on the Truss Design Drawing, or a supplemental document provided by the Truss Designer. It is sometimes also specified in the construction documents prepared by the Building Designer.

*Individual Web Reinforcement (Shop Applied)*

- ✓ Proprietary metal reinforcement products and Stacked Web Reinforcement are installed by the Truss Manufacturer at the Truss plant and eliminate the need for additional jobsite reinforcement of the Webs.
- ✓ Permanent Building Stability Bracing for wind, seismic and/or other lateral loads acting perpendicular to the plane of the Trusses will always be needed in every building.



**FIGURE B10-39**



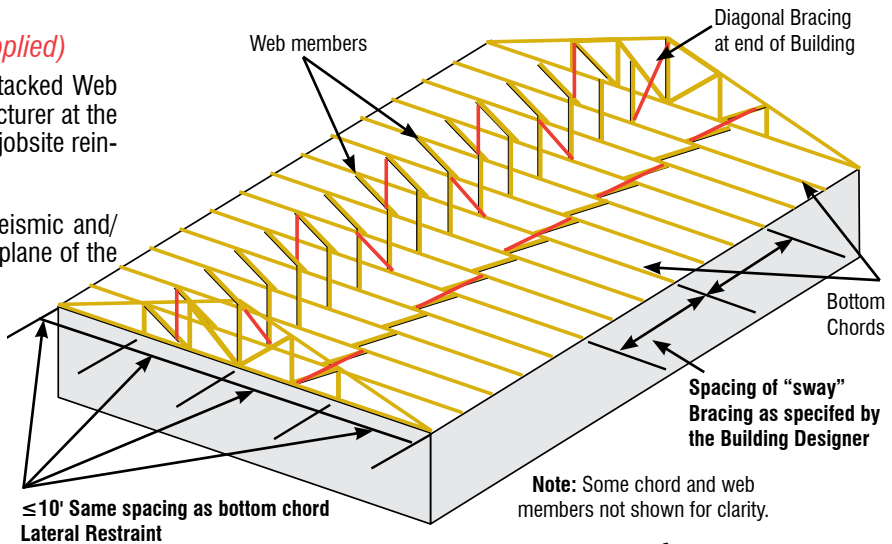
**FIGURE B10-40**

## PERMANENT BRACING FOR SPECIAL CONDITIONS

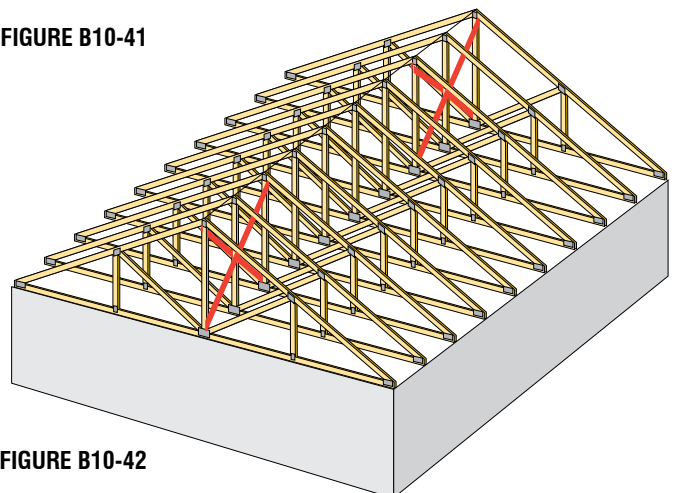
- ✓ Permanent Building Stability Bracing for wind, seismic and/or other lateral Loads acting perpendicular to the plane of the Trusses will always be needed in every Building and is specified by the Building Designer.

### Sway Bracing

- ✓ Diagonal Bracing, installed at both ends of a Building and repeated along the length of the Building at intervals specified by the Building Designer, helps to stabilize the Truss System and minimize the lateral movement due to lateral Loads. Also referred to as “sway” Bracing, this Bracing serves to stiffen the Truss System, thereby greatly reducing stresses caused by movement or displacement of the Trusses.
- ✓ Sway bracing is typically installed on Web members (verticals, whenever possible) located at or near each row of Bottom Chord Lateral Restraint and should extend from the Top Chord Plane to the Bottom Chord Plane at right angles to the Trusses.
- ✓ Sway Bracing is designed and installed at the discretion of the Building Designer and is not always required.
- ✓ Sway Bracing, if continuous, also serves to distribute gravity Loads between Trusses of varying stiffness.



**FIGURE B10-41**



**85 FIGURE B10-42**

## BCSI-B10: Post Frame Truss Installation, Restraint & Bracing

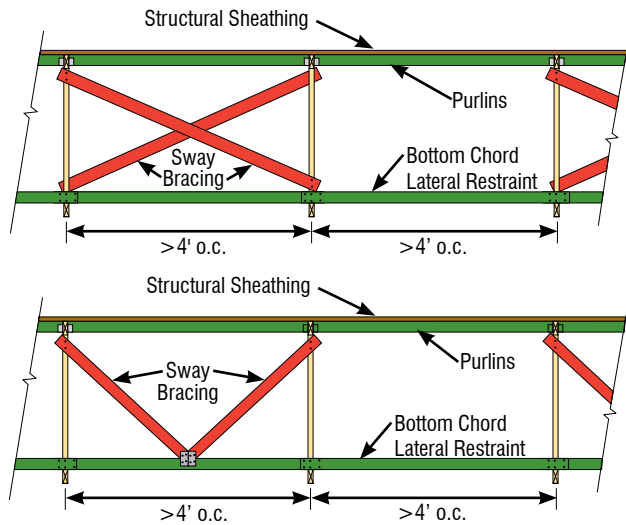
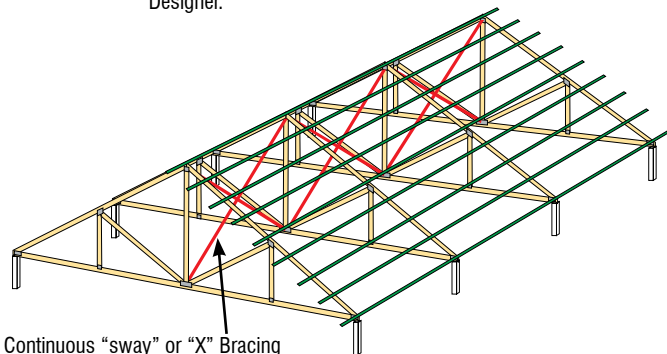


FIGURE B10-43

### NOTICE

Reinforce Lateral Restraint and Diagonal Bracing as required for Truss Spacings greater than 4' o.c. Refer to Table B10-2 on page 80 or as specified by the Building Designer.



Continuous "sway" or "X" Bracing along the length of the Building

FIGURE B10-44

## PERMANENT BRACING FOR THE TOP CHORD IN A PIGGYBACK ASSEMBLY

- ✓ With a Piggyback assembly, make sure that the portion of the Top Chord of the supporting Truss located directly beneath the cap Truss is adequately braced to prevent it from buckling out from under the cap Truss. Bracing for this portion of the Top Chord is accomplished in several ways including:
  - CLR and Diagonal Bracing using stress-graded lumber (Figure B10-45)
  - Connecting the CLR into the roof Diaphragm
  - Applying Structural Sheathing to the CLR
  - Some other equivalent means
- ✓ If Diagonal Bracing is used to Brace the CLR, repeat the Diagonal Bracing at 8' intervals or as specified. Closer spacing may be required by the Building Designer.
- ✓ If Structural Sheathing is used to brace the CLR, provide openings, to permit ventilation within the roof assembly.

- ✓ Refer to the TDD for the maximum assumed spacing for attaching the Lateral Restraint to the Top Chord. The TDD also provides the assumed thickness of the restraint and the minimum Connection requirements between the cap and the supporting Truss or restraint.

### NOTICE

Repeat Diagonal Bracing every 8' or as specified. Closer spacing may be required by the Building Designer. Structural Sheathing, attached to the CLR, may also be used in place of the Diagonal Bracing.

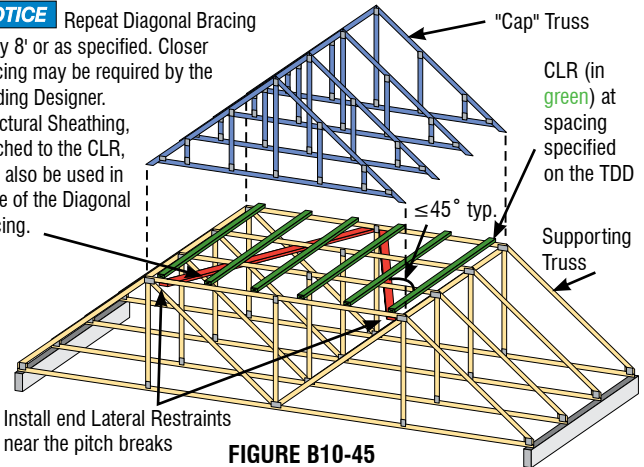


FIGURE B10-45

### NOTICE

Reinforce Lateral Restraint and Diagonal Bracing as required for Truss Spacings greater than 4' o.c. Refer to Table B10-2 on page 80 or as specified by the Building Designer.

- ✓ Install all of the required temporary Restraint and Bracing discussed in this document AND the Top Chord Permanent Restraint and Bracing discussed in this section BEFORE installing the cap Trusses.
- ✓ Refer to **BCSI-B3** for additional information regarding permanent Restraint/Bracing for Truss Chords and Web members.



## WARNINGS & RESPONSIBILITIES

**DISCLAIMER:** The Truss Manufacturer and Truss Designer rely on the presumption that the Contractor and crane operator are professionals and that he/she has the capability to undertake the work they have agreed to do on any given project. If the Contractor believes he/she needs assistance in some aspect of the construction project, he/she should seek assistance from a competent party. The methods and procedures outlined in this document are intended to ensure that the overall construction techniques employed will put the Trusses into place SAFELY. These recommendations for handling, installing, restraining and Bracing Trusses are based upon the collective experience of leading personnel involved with Truss design, manufacture and installation, but must, due to the nature of responsibilities involved, be presented only as a GUIDE for use by a qualified Building Designer or Contractor. It is not intended that these recommendations be interpreted as superior to the Building Designer's design specification for handling, installing, restraining and Bracing Trusses and it does not preclude the use of other equivalent methods for restraining/Bracing and providing stability for the walls, columns, floors, roofs and all the interrelated Structural Building Components as determined by the Contractor. Thus, SBCA, TPI and those who participated in the development of this guide expressly disclaim any responsibility for damages arising from the use, application, or reliance on the recommendations and information contained herein.

## FALL PROTECTION & TRUSSES

**SBCA has created an alternate fall protection plan template, complete with links throughout the document to the applicable steps to follow in its online step-by-step approach to erecting an initial Truss system under OSHA's fall protection requirements. Visit [sbcindustry.com/fp](http://sbcindustry.com/fp).**

Regulations on fall protection and erection/installation of Trusses in residential construction are contained in OSHA's Fall Protection Standard, 29 CFR 1926 Subpart M (the Standard). Section 1926.501(b)(13) of the Standard states in part: "Each employee engaged in residential construction activities 6 feet or more above lower levels shall be protected by guardrail systems, scaffolding, a safety net system or a personal fall arrest system."

### TRUSS SYSTEMS

**⚠ DANGER** Any part of an inadequately braced or sheathed roof or floor Truss system used as an anchorage point for any type of personal fall arrest system is dangerous and will increase the risk of serious injury or death.

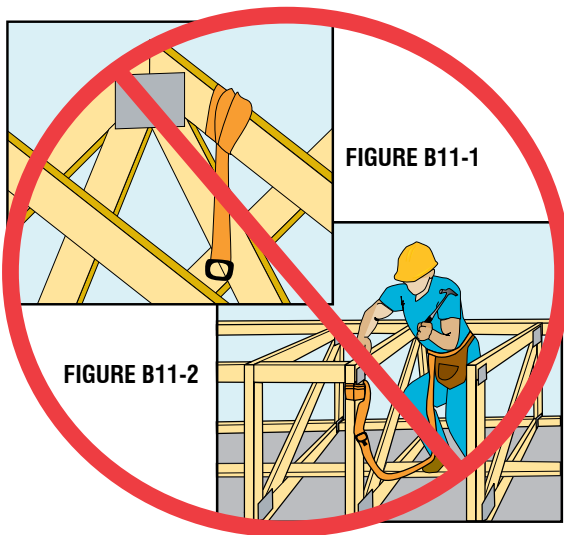


FIGURE B11-1

FIGURE B11-2



PHOTO B11-1

**⚠ WARNING** Roof and floor Trusses that are not properly braced per BCSI or sheathed are not able to resist lateral impact loads associated with falls. A falling worker attached to an inadequately braced set of Trusses could cause all the previously set Trusses to collapse in a domino effect.

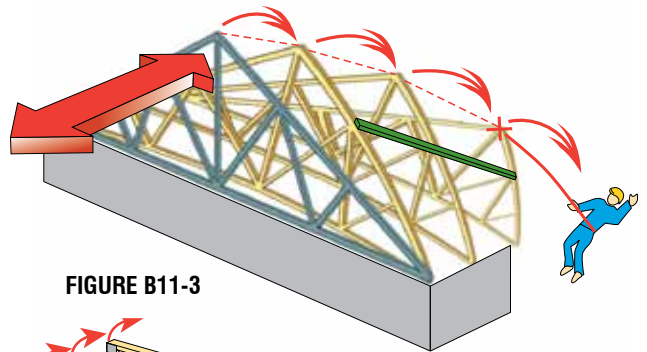


FIGURE B11-3

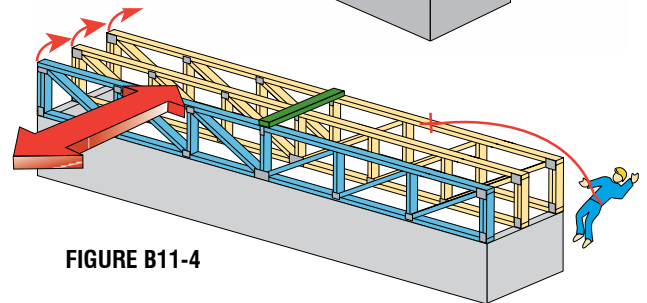


FIGURE B11-4

✓ Refer to **BCSI-B1**, **BCSI-B2** and **BCSI-B7** for recommendations on proper bracing of Trusses.

**⚠ DANGER** Do not walk on unbraced Trusses



FIGURE B11-5



FIGURE B11-6



PHOTO B11-2



PHOTO B11-3

**⚠ DANGER** Do not walk on Trusses or gable end frames lying flat. They do not have the structural strength to support a worker safely while oriented flat.



PHOTO B11-4

### SITE-SPECIFIC JOB HAZARD ASSESSMENT

Fall protection and safety measures are jobsite and building specific. The appropriate fall protection method must be determined through a site-specific job hazard assessment (JHA) conducted by a qualified person who can design, install, and use fall protection systems and is authorized to correct any problems. The JHA is intended to assist in identifying risks and the least hazardous way to install Trusses for a particular job.

Fall hazards identified in the JHA shall be addressed with conventional methods, whenever possible, including: guardrails, scaffolding, safety nets, personal fall arrest systems or catch platforms.

Employers must consider whether it is safer to design and install a safe work platform/system around a hazard.

**⚠ WARNING** All fall protection solutions come with their own inherent hazards during use.

**⚠ CAUTION** Addressing fall protection hazards may be obvious, but other hazards must also be considered when choosing the appropriate site-specific fall protection systems. This includes:

1. electrical hazards, including power lines
2. projectile hazards while using pneumatic nail guns
3. tripping hazards from cords and bracing materials
4. lower level hazards, such as wall bracing, which some fall protection systems do not protect against

### FALL PROTECTION EQUIPMENT INSTALLATION

**⚠ DANGER** Individual Trusses alone are NOT designed to SUPPORT fall protection equipment.

The Contractor is responsible for the construction means, methods, techniques, sequences, procedures, programs, and safety in connection with the receipt, storage, handling, installation, restraining, and bracing of Trusses.

**✓** Refer to ANSI/ASSE Z359.2-2007, Minimum Requirements for a Comprehensive Managed Fall Protection Program, for guidance in meeting minimum fall protection equipment installation and use requirements. This standard refers to equipment only, and does not apply to the underlying structure to which the equipment is attached.

**Commentary E5.4.2.2 of ANSI/ASSE Z359.2-2007** states, "The impact of fall forces on beams, columns and their supports other than anchorages are not addressed by this standard."

**⚠ CAUTION** While the equipment itself may resist the forces generated by a falling worker, it is up to a qualified person to determine whether the building's structural system to which the fall protection equipment is attached meets or exceeds this standard as well.



PHOTO B11-5



PHOTO B11-6

### Scaffolding

Use of interior or exterior scaffolding as a fall arrest system is permitted, but installation and use must adhere to the Standard requirements in 29 CFR 1926.500.

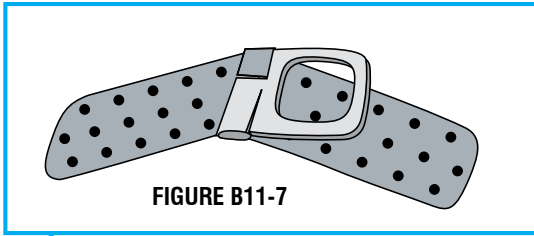


FIGURE B11-7

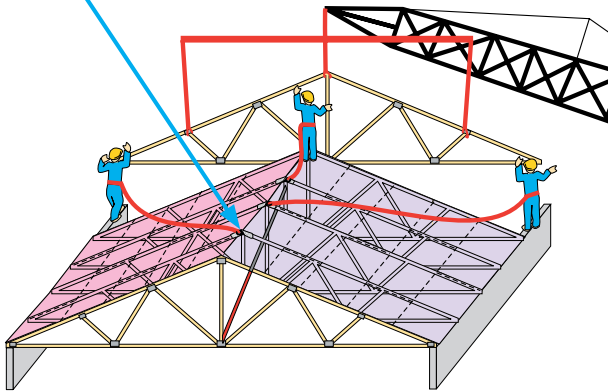


FIGURE B11-8

## Guard Rails

Use of guard rails along the perimeter of the work area as a fall arrest system is permitted, but installation and use must adhere to the Standard requirements in 29 CFR 1926.500.

## Roof Peak Anchors

**⚠️ WARNING** Completely brace, per **BCSI-B1** and **BCSI-B2**, or sheath Trusses before installing a roof anchor for use as a personal fall restraint system. Installation and use must adhere to the Standard requirements in 29 CFR 1926.500.

**⚠️ WARNING** It is always safest to sheath a section (e.g. three or more Trusses) of the roof system before installing a roof anchor for use as a personal fall restraint system. Installation and use must adhere to the Standard requirements in 29 CFR 1926.500.

## ALTERNATIVE FALL PROTECTION PLANS

After conducting a JHA, if the qualified person is able to demonstrate that conventional fall protection measures are infeasible or present a greater hazard to a particular worker or the entire crew, an employer may implement a written alternative fall protection plan in compliance with residential construction fall protection under 29 CFR 1926.501(b)(13).

**29 CFR 1926.501(b)(2)(i)** states, “there is a presumption that it is feasible and will not create a greater hazard to implement at least one of the [listed] fall protection systems. Accordingly, the employer has the burden of establishing that it is appropriate to implement a fall protection plan which complies with 1926.502(k) for a particular workplace situation, in lieu of implementing any of those systems.”

The fall protection plan’s alternative measures must apply to sufficiently trained and experienced workers, and the plan must meet the requirements of 29 CFR 1926.502(k) and be site specific. The use of alternative measures shall be used in conjunction with conventional fall protection systems, and the use of alternative methods shall be as limited as possible.

## Ground Assembly

Pre-assemble a Truss system on the ground. Fully laterally restrain and diagonally brace, per **BCSI-B1** and **BCSI-B2**, the bottom chord and web member planes. Completely brace, per **BCSI-B1** and **BCSI-B2**, or sheath the top chord plane, for adequate stability. Lift and set in place. This pre-assembled section may then be used as an attachment point for personal fall restraint anchorage.



PHOTO B11-7



PHOTO B11-8

**Notes:**



## GLOSSARY OF TERMS

Below is a Glossary of Terms that are intended to assist the reader. All capitalized terms contained within BCSI shall have the meaning set forth in this Glossary of Terms.

**NOTICE**  **WARNING**  **CAUTION**  **DANGER**

The use of this symbol and any of these words is intended to indicate to the reader that an unsafe condition or action will greatly increase the probability of an accident occurring, which could easily result in serious personal injury or death.

**Anchorage:** Connection between the roof or floor framing members (e.g., Trusses, Bracing, etc.) and the Building structure, which is required to transfer the forces from these members into the Building.

**ANSI/TPI 1-2007:** *National Design Standard for Metal Plate Connected Wood Truss Construction*, which covers design responsibilities, quality criteria for Trusses, metal Connector plate manufacturing, performance evaluation of metal connector plated Connections, materials and general design considerations, member design procedures, and metal connector plate joint design.

**B-Series Summary Sheets:** A comprehensive set of Building safety and Bracing documents created by the SBCA and TPI to educate Metal Plate Connected Wood Truss (MPCWT) users of the inherent dangers associated with the handling, installing and Bracing of these products, and to train on how to install MPCWTs safely.

**Blocking:** A solid member placed between structural members, usually at the bearings, to provide lateral support.

**Bottom Chord:** The horizontal or pitched member that defines the lower edge of a Truss, usually carrying combined tension and bending stresses.

**Bottom Chord Bearing:** Bearing condition of a Truss that is supported on its Bottom Chord (see Figure B7-2, page 59).

**Bottom Chord Plane:** The two-dimensional area formed by the top or bottom edge of adjacent similar Bottom Chords allowing for the Connection of ceiling Diaphragm, or Bracing members in a linear fashion.

**Bottom Chord Temporary Lateral Restraint (BCTLR):** Structural members installed at right angles to the Bottom Chord of a Truss during construction to reduce the laterally unsupported length of the Bottom Chord.

**Bracing:** Providing stability against unintended movement or motion. See **Diagonal Bracing** and **Structural Sheathing**.

**Bridging:** Cross bridging placed between structural members, usually at the bearings, to provide lateral support.

**Building:** Structure used or intended for supporting or sheltering any use or occupancy.

**Building Component Safety Information (BCSI):** The jointly produced SBCA/TPI *Guide to Good Practice for Handling, Installing, Restraining and Bracing of Metal Plate Connected Wood Trusses*. BCSI fulfills the policies of the two associations to promote handling, installing and Bracing guidelines for Metal Plate Connected Wood Trusses (MPCWT) that are simple, safe, proven methods consistent with good framing construction practices in the field.

**Building Designer:** Owner of the Building or the person that contracts with the Owner for the design of the Framing Structural System and/or who is responsible for the preparation of the Construction Documents. When mandated by the Legal Requirements, the Building Designer shall be a Registered Design Professional.

**Building Official:** Officer or other designated authority charged with the administration and enforcement of the building code, or a duly authorized representative.

**Ceiling Diaphragm:** The horizontal or sloped structural system defined by the ceiling plane acting to transmit lateral forces to the vertical resisting elements.

**Clinched Nail:** A nail selected to be longer than the member(s) it is driven through and which is bent back the dimension of its excess length.

**Connectors and Connections:** Fasteners that join two or more members together, including: nails, metal plates or Truss Plates, Truss and joist hangers, screws, and bolts.

**Construction Documents:** Written, graphic and pictorial documents prepared or assembled for describing the design (including the Framing Structural System), location and physical characteristics of the elements of a Building necessary to obtain a Building permit and construct a Building.

**Construction Loading:** The Loads from workers and building materials on an unfinished structure, for example, when builders stack bundles of panel sheathing or gypsum board on Trusses during the construction process.

**Continuous Lateral Restraint (CLR):** A line of structural members (typically lumber or metal) installed at right angles to a chord or web member of a Truss to reduce the laterally unsupported length of the Truss member. The CLR must be properly braced to prevent the simultaneous lateral deformation and/or buckling of the series of Truss members to which it is attached due to laterally imposed Loads on, and/or the accumulation of buckling forces within, the Truss members, respectively. See **Lateral Restraint**.

**Contract:** Legally recognized document between two parties.

**Contractor:** Owner of a Building, or the person who contracts with the Owner, who constructs the Building in accordance with the Construction Documents and the Truss Submittal Package. The term “Contractor” shall include those subcontractors who have a direct Contract with the Contractor to perform all or a portion of the construction.

**Conventional Fall Protection Systems:** Under 29 CFR 1926.500(b), conventional fall protection systems include: “guardrail system, safety net system, or personal fall arrest system.” See **Personal Fall Arrest System**.

**Conventional Framing:** Framing with conventional joists, rafters and wall studs.

**Conventional Light-frame Wood Construction:** A type of construction whose primary structural elements are formed by a system of repetitive wood-framing members. This includes wood Truss construction.

**Cross Bracing:** A type of Diagonal Bracing in which the Bracing members are crossed to form an “X.” Cross Bracing is installed in the Web Member Plane of Trusses to transfer lateral Loads out of the Truss system into the roof and Ceiling Diaphragms. Also referred to as “sway Bracing” or “X Bracing.” See **Diagonal Bracing**.

**Cross Bridging:** Wood or metal members that are placed between Trusses or joists in an angled position, usually at the bearings, intended to spread the Load and stabilize the members.

**Deformed Shank Nails:** Ring, or screw shaped configuration of a nail shank.

**Diagonal Bracing:** Structural member installed at an angle to a Truss chord or web member and intended to temporarily and/or permanently stabilize Truss Member(s) and/or Truss(es) (see **BCSI-B1**, **BCSI-B2**, **BCSI-B3**, **BCSI-B7** and **BCSI-B10**).

**Diaphragm:** Horizontal or sloped system defined by the ceiling, floor or roof plane acting to transmit lateral forces to the vertical lateral force resisting elements (e.g., walls).

**DSB-89:** *Recommended Design Specification for Temporary Bracing of Metal Plate Connected Wood Trusses*. A TPI publication developed for use by architects and engineers to provide guidance for designing structural Bracing.

**Duration of Load:** Total length of time during which a Load acts on a member. In wood, a design consideration for modifying allowable stresses, based on the accumulated Loadings anticipated during the life of a structure.

**Exterior Ground Brace:** See **Ground Bracing** and Figure B2-3, page 19.

**Fall Protection Plan:** A written plan prepared for the prevention of injuries associated with falls. A Fall Protection Plan must be developed and evaluated on a site-by-site basis.

**Floating Connection:** A Connection between Trusses or Structural Elements and non-load bearing interior walls that allows for seasonal movement. Wood blocking or specially designed slotted metal clips can be used to hold the Truss in alignment and allow for this movement.

**Framing Structural System:** Completed combination of structural elements, Trusses, Connections and other systems, which serve to support the Building’s self-weight and the specified Loads.

**Gable End Frame:** A component manufactured to complete the end wall of a Building. The Bottom Chord of the Gable End Frame has continuous vertical support provided by the end wall or beam. Vertical members between the Top and Bottom Chords are typically spaced at 24" on-center. The vertical members function as Load carrying members and as attachment members for sheathing or other end wall coverings. The Gable End Frame must be incorporated into the end wall by the Building Designer.

**Gambrel:** Roof having two slopes on each side of the peak, the lower slope usually steeper than the upper one (see Figure B2-15, page 22).

**Girder Truss:** Truss designed to carry heavy loads from other structural members framing into it. Usually a Multiple-Ply Truss.

**Ground Bracing:** Used to provide stability for the first Truss or group of Trusses installed. It is composed of vertical and diagonal members providing support for the installed Trusses from the earth, floor, foundation or slab. Ground Bracing should be located in line with the Top Chord Lateral Restraint. Proper Ground Bracing also requires lateral and strut Bracing to ensure stability and support (see Figures B2-3 and 4, page 19).

**Ground Bracing Components:** See also **Ground Bracing** and Figures B2-3 and 4, page 19.

- Backup Ground Stake
- Driven Ground Stake
- End Diagonal Brace
- Ground Brace Diagonal
- Ground Lateral Restraint
- Ground Brace Vertical
- Horizontal Tie Member
- Strut

### **Commentary from DSB-89 on Ground Bracing:**

**Connections:** The installer should provide adequate Connections between the Ground Bracing system and the first braced Truss to resist the cumulative brace force (P) as determined in Section 4 and Appendix A of DSB-89. A minimum of 2-16d nails (0.135x3.5") nailed in accordance with NDS® criteria should be used for each Connection in the Ground Brace system.

**Diagonals:** Ground Brace Diagonals should be continuous from the point at which the Ground Brace Vertical is attached at the top chord of the braced Truss down at about a 45° angle to a Ground Stake. The diagonal should be connected to the ground stake and to the vertical with adequate Connections.

**End Diagonal Brace:** When Ground Brace Diagonals require Bracing, the Ground Brace Diagonals at each end of the Ground Brace system should be restrained laterally from the midpoint of the Ground Brace Diagonal down at about 45° to a driven stake and denoted as end Diagonal Braces (see Figure B2-3 and 4, page 19).

**Ground Stakes:** If soil conditions are poor, it may be necessary to add a Horizontal Tie Member at ground level to connect the lower end of the Ground Brace Vertical and the lower end of the Ground Brace Diagonal. Then, it is possible to drive multiple stakes along the length of this horizontal Tie Member as needed to develop the required lateral resistance by the earth. A Backup Ground Stake is an alternate method of reinforcement in poor soil conditions (see Figure B2-3, page 19).

The proper placements and capacities of all ground stakes are the responsibility of the installer.

The ground stake should be driven to a capacity which will resist one and one half times the cumulative lateral bracing force (P) as determined from DSB-89.

**Responsibility:** The installer is responsible for the proper selection of lumber sizes, Connections and installation of the Ground Bracing system.

**Splices:** Splices for Ground Bracing should occur only at a point that is laterally restrained. Splices for Ground Bracing, if constructed with wood members, should have a minimum three-foot overlap nailed with a minimum of ten 16d (0.135x3.5") nails, nailed in accordance with NDS® specifications and clinched for safety.

**Struts:** Struts, where needed, should be connected between the midpoint of the Ground Brace Diagonal and the lower end of the Ground Brace Vertical. Struts should be no less than 2x4 Stress-Graded Lumber and should be nailed with a minimum of 2-16d (0.135x3.5") nails clinched at each Connection.

**Hip Set:** Series of Trusses of the same span and Overhang that decrease in height to form the end slope of a hip roof system. Also called a step-down Truss System.

**Hip Truss:** Trusses used in a hip set roof system. Each Hip Truss has the same span and Overhang as the adjacent standard Trusses but decreases in height with the Top and Bottom Chords of its center portion parallel to each other and horizontal. Also referred to as a step-down Truss.

**Infeasible:** Under 29 CFR 1926.500(b), “infeasible means that it is impossible to perform the construction work using a conventional fall protection system (i.e., guardrail system, safety net system, or personal fall arrest system) or that it is technologically impossible to use any one of these systems to provide fall protection.”

**Interior Ground Brace:** See **Ground Bracing** and Figure B2-4, page 19.

**I-Reinforcement:** Two pieces of stress-graded lumber attached to a web as reinforcement against buckling instability. The wide face of each reinforcing member is attached to the narrow faces of the web, forming an I shape.

**Jurisdiction:** Governmental unit that is responsible for adapting and enforcing the Building code.

**Knee Brace:** Brace positioned between a column and Truss panel points when Trusses are supported by columns lacking transverse Bracing.

**L-Reinforcement:** A piece of stress-graded lumber attached to a web as reinforcement against buckling instability. The wide face of the reinforcing member is attached to the narrow face of the web, forming an L shape.

**Lateral Bending:** Bending out of the plane of the Truss.

**Lateral Restraint:** Also known as continuous lateral brace or CLB. A structural member installed at right angles to a chord or Web member of a Truss to reduce the laterally unsupported length of the Truss member (see **BCSI-B1**, **BCSI-B2**, **BCSI-B3**, **BCSI-B7** and **BCSI-B10**).

**Legal Requirements:** Any applicable provisions of all statutes, laws, rules, regulations, ordinances, codes, or orders of the governing Jurisdiction.

**Lift:** The act of mechanically or manually hoisting.

**Live Load:** Loads produced by the use and occupancy of the Building, which do not include construction or environmental Loads such as Wind Load, snow Load, rain Load, earthquake Load, flood Load or dead Load.

**Load:** Forces or other actions that arise on structural systems from the weight of all permanent construction, occupants and their possessions, environmental effects, differential settlement and restrained dimensional changes.

**Long Span Trusses:** Trusses with a clear span of 60' or greater.

**Machine-Stress Rated Lumber (MSR):** Type of machine-graded lumber designated by the design bending stress,  $F_b$ , and modulus of elasticity, MOE or E, values. For example, an MSR grade of 1650f-1.5E designates the bending stress of 1650 psi and an MOE of 1.5 million psi. Other design properties are listed in the National Design Specification® (NDS®).

**Mean Roof Height:** The elevation of the roof mid-way between the eave and the ridge (see Figure B3-29, page 46).

**Metal Connector Plate:** See **Truss Plate**.

**Metal Plate Connected Wood Truss (MPCWT):** Engineered, pre-fabricated structural component, assembled from wood members and metal connector plates, and designed to carry superimposed dead and live Loads. The Truss members form a rigid, planar, structural component and are usually assembled such that the members form triangles.

**Mono Truss:** Truss that has a single Top Chord, and a slope greater than 1.5/12.

**Multi-Ply Truss:** A Truss designed to be installed as an assembly of two or more individual Trusses fastened together to act as one. Ply-to-ply Connections of multi-ply Trusses are specified on the Truss Design Drawing.

**Nail-On Plate:** Light-gauge cold-formed steel metal connector plates with pre-punched holes or, if cut to size, without holes but having identifying marks through which nails are driven by hand or power means into the lumber. They are typically used in repairs.

**National Design Specification® (NDS®) For Wood Construction:** Publication of the American Wood Council (AWC), this Standard is referenced by model building codes for structural design of wood buildings. Also includes a supplement of lumber sizes, grades, species and allowable stresses.

**Overhang:** Extension of the Top Chord of a Truss past the Bottom Chord to form the eave/soffit framing of the roof.

**Owner:** Person having a legal or equitable interest in the property upon which a Building is to be constructed, and: (1) either prepares or retains the Building Designer or Registered Design Professional to prepare the Construction Documents; and (2) either constructs or retains the Contractor to construct the Building.

**Panel Point:** Location on a Truss where the Web members and Top or Bottom Chords intersect and are connected by Metal Connector Plates.

**Parallel Chord Truss (PCT):** Truss with Top and Bottom Chords with equal slopes.

**Permanent Building Stability Bracing (PBSB):** Lateral force resisting system for the Building that resists forces from gravity, wind, seismic, and/or other Loads.

**Permanent Individual Truss Member Restraint (PITMR):** Restraint that is used to prevent local buckling of an individual Truss chord or Web member due to the axial forces in the individual Truss member (see [BCSI-B2](#) and [BCSI-B3](#)).

**Personal Fall Arrest System:** An individual worker's Fall Protection System, composed of a safety belt or full body harness, and lanyard, lifeline, and any other connecting equipment that is used to secure the worker to an individual anchor or to a horizontal lifeline system; designed to stop a worker's fall before the worker hits the surface below.

**Piggyback Truss:** Truss made and shipped to the jobsite in two

pieces consisting of a supporting Truss with a triangular supported (i.e., "cap") Truss. The supporting Truss and cap Truss are attached to one another at the jobsite. Piggyback Trusses are used when shipping or manufacturing restrictions limit the overall Truss height.

**Proprietary Metal Restraint/Bracing Products:** Metal products used as Diagonal Bracing, Lateral Restraint, Bridging and Web Reinforcement, which are available from a number of manufacturers as alternatives to wood products.

**Purlins:** Structural horizontal members attached perpendicular to the Truss Top Chord used to provide Lateral Restraint to the Top Chord and to support and transfer the roof Loads to the Trusses.

**Qualified Person:** Under 29 CFR 1926.503(a)(2), a qualified person is one who should have knowledge, and be able to provide training to others, in the following areas: "the nature of fall hazards in the work area; the correct procedures for erecting, maintaining, disassembling, and inspecting the fall protection systems to be used; the use and operation of guardrail systems, personal fall arrest systems, safety net systems, warning line systems, safety monitoring systems, controlled access zones, and other protection to be used; the role of each employee in the safety monitoring system when this system is used; the limitations on the use of mechanical equipment during the performance of roofing work on low-sloped roofs; the correct procedures for the handling and storage of equipment and materials and the erection of overhead protection; and, the role of employees in fall protection plans."

**Registered Design Professional (RDP):** Architect or engineer, who is licensed to practice their respective design profession as defined by the Legal Requirements of the Jurisdiction in which the Building is to be constructed.

**Repair Detail:** A written, graphic or pictorial depiction of the required fix to an altered or damaged Truss or part.

**Ribbon:** Framing member installed on the edge of the exterior perimeter, usually tying the ends of floor Trusses together.

**Rigid ceiling:** See Ceiling Diaphragm.

**Rim Joist:** Full-depth framing member installed on the edge of the exterior perimeter, used to provide lateral support and to tie the ends of floor Trusses together. Also referred to as a band board.

**Scab:** Member fastened to another member for reinforcement.

**Scab Reinforcement:** A piece of Stress-Graded Lumber attached to a Web as reinforcement against buckling instability. The wide face of the reinforcing member is attached to the wide face of the Web.

**Scissors Truss:** Dual pitch, triangular Truss with dual pitched Bottom Chords (see Figure B2-17, page 22).

**Seismic Load:** Assumed Load acting in any direction on the Building and its Structural Elements due to the dynamic action of earthquakes.

- Short Member Temporary Lateral Restraint:** Short pieces of 2x4 or larger members fastened at right angles to the Truss Chords during installation of the Trusses for the purpose of reducing the laterally unsupported length of the Truss member. Multiple sets of Diagonal Bracing must be installed simultaneously with each set of Short Member Temporary Lateral Restraint (see Option B of **BCSI-B2**, page 28).
- Spreader Bar:** A specifically designed lifting device that enables the lifting cables to hang straight or toe-in to their points of Connection so as not to induce buckling forces in the Truss being lifted.
- Stacked Web Reinforcement:** Reinforcement member plated to the narrow face of a Web in the Truss plant to avoid the need for field-installed reinforcement or Lateral Restraint and Bracing.
- Stiffback:** The Spreader Bar when it is brought down along side and attached directly to the Truss being lifted to provide sufficient rigidity to adequately resist out-of-plane bending of the Truss. See **Spreader Bar**.
- Stress-Graded Lumber:** Lumber of any thickness and width that is graded for its mechanical properties.
- Strongbacking:** Nominal 2x6 or greater Stress-Graded Lumber attached perpendicular to floor Trusses, often through the chase opening, and placed vertically against a vertical Web, or vertical block attached to the side of the Truss.
- Structural Building Components:** Specialized structural Building products designed, engineered and manufactured under controlled conditions for a specific application. They are incorporated into the overall Building Structural System by the Building Designer. Examples are roof Trusses, floor Trusses, floor panels, wall panels, I-joists, beams, headers, lintels, Structural Sheathing, columns, etc.
- Structural Composite Lumber (SCL):** Composite of wood veneer sheets, wafers, or wood strand elements, joined with an adhesive with wood fibers primarily oriented along the length of the member. These materials are intended for structural use. Examples include LVL, PSL and LSL.
- Structural Element:** Single structural member (other than a Truss) that is specified in the Construction Documents.
- Structural Sheathing:** The structural covering used directly over the roof, floor or wall framing members that transfers perpendicular Loads to the framing members. Structural Sheathing commonly used with Trusses includes plywood, oriented strand board (OSB), and certain types of metal decking. Properly sized and installed, Structural Sheathing provides both Lateral Restraint and stability to the Truss members.
- Submittal Documents:** Construction Documents, special inspection and structural observation programs, data, guides, reports, and manufacturer's installation instructions submitted for approval with each permit application or available at the jobsite at the time of inspection.
- T-Reinforcement:** A piece of Stress-Graded Lumber attached to a Web as reinforcement against buckling instability. The wide face of the reinforcing member is attached to the narrow face of the Web, forming a T shape.
- Temporary Installation Restraint/Bracing:** Lateral Restraint and Diagonal Bracing installed during construction for the purpose of holding Trusses in their proper location, plumb and in plane, until Permanent Individual Truss Member Restraint, Diagonal Bracing and Permanent Building Stability Bracing are completely installed (see **BCSI-B1**, **BCSI-B2**, **BCSI-B3**, **BCSI-B7** and **BCSI-B10**).
- Temporary Lateral Restraint:** Lateral Restraint that is attached to Truss members during installation of the Trusses and is intended to be temporary. See **Lateral Restraint**.
- Toe-nail:** Nail driven at an angle to the member.
- Top Chord:** Inclined or horizontal member that establishes the top edge of a Truss, usually carrying combined compression and bending stresses.
- Top Chord Bearing:** Bearing condition of a Truss that bears on its Top Chord extension (see Figure B7-3, page 59).
- Top Chord Plane:** The two-dimensional area formed by the top or bottom edge of adjacent similar Top Chords, allowing for the Connection of a Diaphragm or Bracing members in a linear fashion.
- Top Chord Temporary Lateral Restraint (TCTLR):** Structural members installed at right angles to the Top Chord of a Truss during construction to reduce the laterally unsupported length of the Top Chord.
- Triangulation:** The act of forming rigid triangles with objects adequately fastened together (see Figure B2-28, page 25).
- Truss:** Individual metal plate connected wood component manufactured for the construction of the Building.
- Truss Design Drawing (TDD):** Written, graphic and pictorial depiction of an individual Truss that includes information required in ANSI/TPI 1.
- Truss Design Engineer:** Person who is licensed to practice engineering as defined by the Legal Requirements of the Jurisdiction in which the Building is to be constructed and who supervises the preparation of the Truss Design Drawings.
- Truss Designer:** Person responsible for the preparation of the Truss Design Drawings.
- Truss Heel Height:** Vertical depth of the Truss at the outside face of bearing.
- Truss Manufacturer:** Person engaged in the fabrication of Trusses.
- Truss Orientation:** Truss position or alignment within a structure relative to bearing walls.
- Truss Placement Diagram (TPD):** Illustration identifying the assumed location of each Truss.
- Truss Plate:** Individual Metal Connector Plate manufactured from ASTM A446, A591, A792 or A167 structural quality steel protected with zinc or zinc-aluminum alloy coatings or their stainless steel equivalent. The Truss Plate has integral teeth and is manufactured in various sizes (i.e., lengths and widths) and thicknesses or gages and is designed to laterally transmit loads when embedded in wood members.

- Truss Profile:** A side view representation or outline of a Truss.
- Truss Spacing:** Distance or void between two adjacent Trusses in a row of Trusses. Typically dimensional/measured center to center.
- Truss Span:** Horizontal distance between outside edges of exterior bearings.
- Truss Submittal Package:** Package consisting of each individual Truss Design Drawing, and, as applicable, the Truss Placement Diagram, the Cover/Truss Index Sheet, Lateral Restraint and Diagonal Bracing details designed in accordance with generally accepted engineering practice, applicable BCSI defined Lateral Restraint and Diagonal Bracing details, and any other structural details germane to the Trusses.
- Truss System:** Assemblage of Trusses and Girder Trusses, together with all Bracing, Connections, and other Structural Elements and all spacing and location criteria, that, in combination, function to support the dead, Live and Wind Loads applicable to the roof of a structure with respect to a Truss System for the roof, and the floor of a structure with respect to a Truss System for the floor. A Truss System does not include walls, foundations, or any other structural support systems.
- U-Reinforcement:** Two pieces of Stress-Graded Lumber attached to a Web as reinforcement against buckling instability. The wide face of each reinforcing member is attached to the narrow faces of the Web, forming a U shape.
- Valley Set:** Set of triangular components used to frame the shape of dormers and to complete the roof framing where Trusses intersect at perpendicular corners.
- Web Member Plane:** Two-dimensional area formed by the top or bottom edge of adjacent similar Web members allowing for the Connection of Lateral Restraint and Bracing members.
- Web Reinforcement:** Piece of structural material attached to a Web as reinforcement against buckling instability. Types of Web Reinforcement include T, L, I, U, Scab, Stacked Web and proprietary metal reinforcement.
- Webs:** Members that join the Top and Bottom Chords to form the triangular patterns typical of Trusses. These members typically carry axial forces.
- Wind Load:** Load created by the wind as determined for design purposes, usually described in pounds per square foot of the area being affected.
- Wind Speed:** Design Wind Speed for the structure. The value is determined by the Building Designer, with the minimum determined by the building code in effect in the Jurisdiction where the structure is built.
- Worker Lift:** Machine intended to mechanically hoist a worker.

## REFERENCE

### INDUSTRY ASSOCIATIONS & GOVERNMENTAL AGENCIES

#### American Wood Council

222 Catoctin Circle, SE, Suit 201 • Leesburg, VA 20175  
202/463 2766 • 202/463-2791 fax  
awc.org

#### American Institute of Architects (AIA)

1735 New York Ave NW • Washington, DC 20006-5292  
202/626-7300 • 202/626-7547 fax  
aia.org

#### American National Standards Institute (ANSI)

25 West 43rd Street, 4 floor • New York, NY 10036  
212/642-4900 • 212/398-0023 fax  
ansi.org

#### American Society of Agricultural and Biological Engineers (ASABE)

2950 Niles Rd • St Joseph, MI 49085  
269/429-0300 • 269/429-3852 fax  
asabe.org

#### American Society of Civil Engineers (ASCE)

1801 Alexander Bell Dr • Reston, VA 20191-4400  
800/548-2723 • 703/295-6222 fax  
asce.org

#### Association of Crane & Rigging Professionals

PO Box 87907 • Vancouver, WA 98687-7907  
800/690-3921 • 360/834-3507 fax  
acrpn.net

#### National Association of Home Builders (NAHB)

1201 15th St NW • Washington, DC 20005  
202/266-8200 • 202/266-8400 fax  
nahb.org

#### National Frame Builders Association (NFBA)

4700 W Lake Ave • Glenview, IL 60025  
800/557-6957 • 847/375-6495 fax  
nfba.org

#### Occupational Safety and Health Administration (OSHA)

US Department of Labor  
Occupational Safety & Health Administration  
200 Constitution Ave NW • Washington, DC 20210  
800/321-6742  
osha.gov

#### Structural Building Components Association (SBCA)

6300 Enterprise Lane • Madison, WI 53719  
608/274-4849 • 608/274-3329 fax  
sbcindustry.com

#### Truss Plate Institute (TPI)

218 N Lee St Ste 312 • Alexandria, VA 22314  
703/683-1010 • 866/501-4012 fax  
tpinst.org

### INDUSTRY STANDARDS, GUIDELINES & RECOMMENDATIONS

**Commentary for Permanent Bracing of Metal Plate Connected Wood Trusses by John Meeks, P.E. (1999):** This document is intended to provide guidelines for Building Designers to use in designing and specifying permanent bracing for Metal Plate Connected Wood Truss Systems.

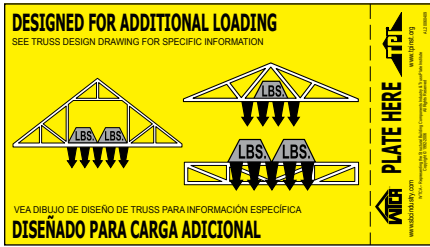
**DSB-89: Recommended Design Specification for Temporary Bracing of Metal Plate Connected Wood Trusses -** Publication of TPI developed for use by architects and engineers to provide guidance for designing structural Bracing.

**Metal Plate Connected Wood Truss Handbook - Third Edition:** Publication of SBCA, this reference book on Metal Plate Connected Wood Trusses has been updated with the most current industry standards and building codes, history, design, fabrication, testing, quality assurance, Connection details, fire resistance assemblies and much more. Also included are appendices containing roof and floor span tables, design aids, specifications, a glossary, industry associations, and a list of SBCA members.

#### National Design Specification® (NDS®) For Wood Construction:

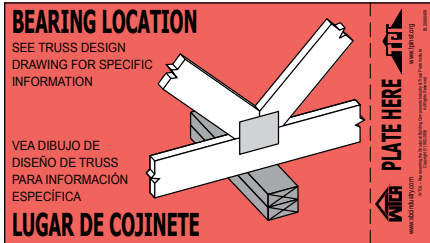
A publication of the American Wood Council (AWC), this standard is referenced by model building codes for structural design of wood Buildings. Also includes a supplement of lumber sizes, grades, species and reference design values.

SUPPLEMENTAL INFORMATION TAGS



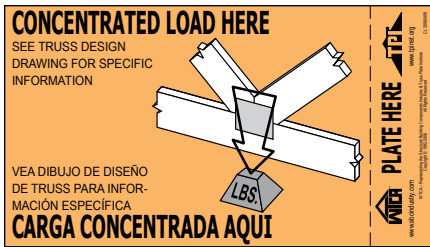
**AL-T: DESIGNED FOR ADDITIONAL LOADING**

This tag informs that the Truss has been designed to support heavier Loads in this particular area (e.g., attic frame floor Loads, rooftop mechanical units, storage Loads, etc.).



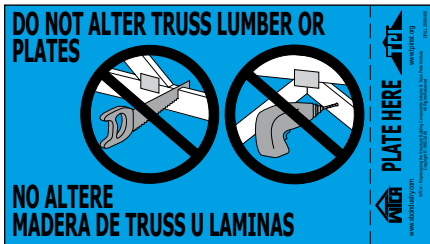
**BL-T: BEARING LOCATION**

Place this tag at points where additional or interior bearing supports should be located under the Truss.



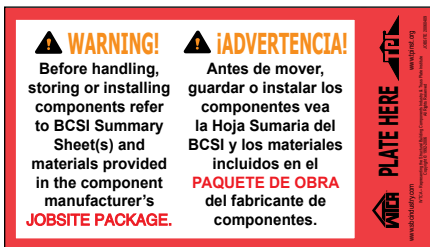
**CL-T: CONCENTRATED LOAD**

Place this tag at the spot where a Truss is to support a concentrated or point Load.



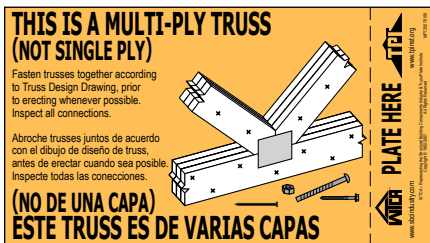
**DRILL-T: DO NOT CUT, DRILL OR ALTER**

This tag emphasizes that Trusses should not be cut or modified in any way.



**JOBSITE-T: JOBSITE WARNING**

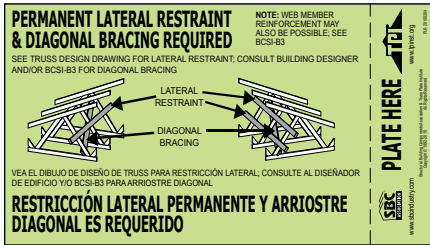
This tag warns to refer to instruction material for proper handling, storing, restraining and Bracing information.



**MPT-T: MULTI-PLY TRUSS**

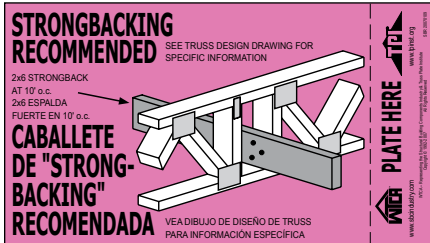
This tag emphasizes that the Truss is not to be used singly and refers the installer to the Truss Design Drawing for multi-ply Connection requirements.





## PLRB-T: PERMANENT LATERAL RESTRAINT AND DIAGONAL BRACING

This tag indicates that the designated member requires Lateral Restraint and Diagonal Bracing and instructs the installer to look for more information on the Truss Design Drawing, **BCSI-B3** and from the Building Designer.



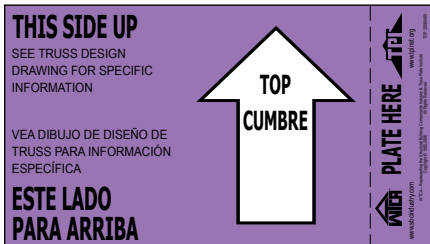
## SBR-T: STRONGBACKING

This tag recommends the use of 2x6 Strongbacking at 10' o.c. It tells the installer to check the Truss Design Drawing for more specific information.



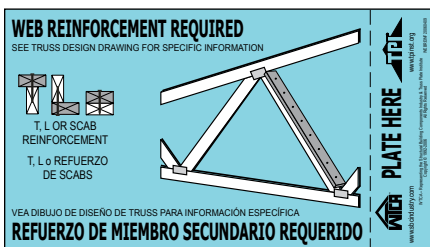
## TEMPBRACE-T: TEMPORARY RESTRAINT & BRACING

This tag complements **BCSI-B1** & **BCSI-B2** Summary Sheets. Place this tag on Trusses to indicate the need for temporary restraint and Bracing. This tag will assist you in providing safety information to your customers, and draws attention to the summary sheets, which give detailed information on how to install temporary restraint and Bracing.



## TOP-T: THIS SIDE UP

This tag reduces the chance that Parallel Chord Trusses will be inadvertently installed upside down.



## WEBREINF-T: WEB REINFORCEMENT

This tag identifies particular Webs that require Web Reinforcement including T-Reinforcement, L-Reinforcement and Scab Reinforcement.

# IMPORTANT SAFETY INFORMATION



## Quick Reference Guide to BCSI B-Series Summary Sheets



- BCSI-B1** Guide for Handling, Installing, Restraining & Bracing of Trusses
- BCSI-B2** Truss Installation & Temporary Restraint/Bracing
- BCSI-B3** Permanent Restraint/Bracing of Chords & Web Members
- BCSI-B4** Construction Loading
- BCSI-B5** Truss Damage, Jobsite Modifications & Installation Errors
- BCSI-B6** Reserved for future use
- BCSI-B7** Guide For Handling, Installing and Bracing of 3x2 and 4x2 Parallel Chord Trusses
- BCSI-B8** Using Toe-Nailed Connections to Attach Trusses at Bearing Locations
- BCSI-B9** Multi-Ply Girders
- BCSI-B10** Post Frame Truss Installation, Restraint & Bracing
- BCSI-B11** Fall Protection & Trusses



**Truss Plate Institute (TPI)**

218 N Lee St Ste 312 • Alexandria, VA 22314  
703/683-1010 • 866/501-4012 fax • tpinst.org



**Structural Building Components Association (SBCA)**

6300 Enterprise Lane • Madison, WI 53719  
608/274-4849 • 608/274-3329 fax • sbcindustry.com

## **Disclaimer**

This copyrighted document is a secure PDF, and while it can be opened, saved and emailed, it cannot be printed. To order copies, contact SBCA at 608/274-4849.